

**Imperial College
London**

**Centre for
Bio-Inspired Technology**

Annual Report 2018



Centre for Bio-Inspired Technology
Department of Electrical and
Electronic Engineering
Imperial College London
South Kensington
London SW7 2AZ

T +44 (0)20 7594 0701

F +44 (0)20 7594 0704

bioinspired@imperial.ac.uk

www.imperial.ac.uk/bioinspiredtechnology

 **@ImperialCBIT**

Centre for Bio-Inspired Technology

Annual Report 2018

3	Director's foreword	27	Research funding
4	Founding Sponsor's foreword	28	Chip gallery
5	People	30	Research facilities
7	Research strategy	32	CBIT goes social
	8 Genetic technology	35	Who we are
	10 Metabolic technology		36 Academic staff profiles
	14 Cancer technology		41 Administrative staff profiles
	16 Bio-modelling		42 Staff research reports
	18 Infection technology		57 Research students' and assistants' reports
	22 Neural technology		

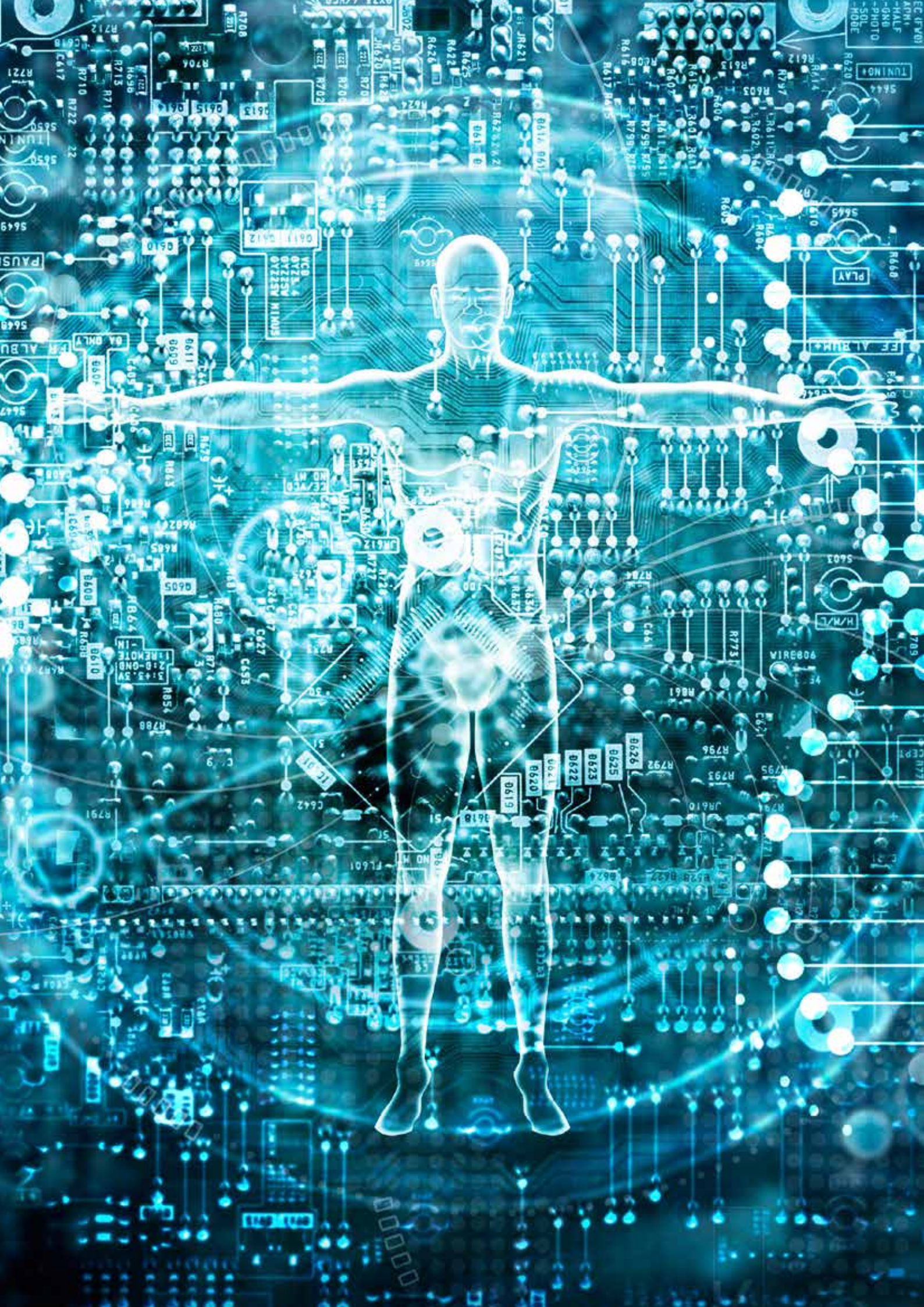

Director's foreword



Since its inception in 2009, the Centre for Bio-Inspired Technology has continued to go from strength to strength, and this past year has been no different. Our members have achieved international recognition for their work, produced ground-breaking research, and have been the recipients of numerous grants from research councils and industry collaborations.

Since our last report in 2017, our researchers have been awarded funding from the Engineering and Physical Sciences Research Council (EPSRC), Cancer Research United Kingdom (CRUK) and the European Research Council (ERC). Together with Dr. Melpomeni Kalofonou, we have been awarded a CRUK Multidisciplinary Project Award for Mi-CARE: A Microchip-based diagnostic Companion for Early Detection and Therapeutic Monitoring of Breast Cancer. Dr. Kalofonou was also awarded an Impact Acceleration Award from the EPSRC for the project: Development of a novel method for quantification of DNA Methylation in cancer patients. With Dr. Konstantin Nikolic, we have been awarded a Proof of Concept Grant from the ERC, for the project: Quantification of Proteins based on Amplification of DNA Displaced from DNA-Aptamer Duplex using Semiconductor Technology (DNA_{sens}PROT). Dr. Tim Constandinou has been awarded a prestigious EPSRC Programme Grant in collaboration with the University of Southampton, on Functional Oxide Reconfigurable Technologies (FORTE). Our CBIT members have presented their work across the globe at a number of conferences including FENS Forum of Neuroscience,

the 40th Annual International Conference of the IEEE Engineering in Medicine and Biology Society (EMBC), ISCAS 2018, and BioCAS 2018, which had impressive CBIT representation with 10 members presenting their work. Dr. Pau Herrero Vinas has also been an invited speaker at the American Diabetes Association Conference in Florida, and at the Artificial Intelligence in Healthcare Conference in London. Dr. Tim Constandinou was the Technical Chair of the IEEE BioCAS 2018 Conference and General Chair of IEEE NeuroCAS 2018. Our researchers have also received numerous awards including: two EPSRC Doctoral Prize Fellowships, ISCAS 2018 Best Student Paper Award, the Stella Bagrit Centenary Memorial Award, and the Ash Prize for Best Academic Performance to name a few. Amongst many publications in the past 12 months, we are excited to see the release of a Neural Interfaces Report from the Royal Society in early 2019, of which both Dr. Tim Constandinou and I are Co-Chair and Chair respectively. We congratulate Dr. Khalid Mirza for obtaining his PhD. Although we are sad to lose her from our CBIT community, we are delighted to congratulate Dr. Sara Ghoreishizadeh for attaining a Lectureship position at University College London.

DNAe, one of our centre's spin-out companies, has had a very successful year being awarded two major awards: The OBN award for the The Best Diagnostic MedTech Company by the Oxford Biosciences Network, for their work in sepsis diagnostics, and the award for the Most Innovative Team or Innovator of the Year award at the MedTech Insights Awards in 2018.

We have two exciting clinical trials underway in the field of diabetes. Our team, led by Dr. Pantelis Georgiou, are evaluating the bio-inspired artificial pancreas (BiAP) system to help people with type 1 diabetes. The BiAP system is an artificial intelligence system that provides real-time feedback for insulin advice. This ground-breaking technology has the potential to revolutionise the treatment of type 1 diabetes. We also have a clinical trial tackling type 2 diabetes under the project: Assessment of the Impact of a Personalised Nutrition Intervention in Impaired Glucose Regulation (ASPIRE-DNA). Participants in this trial will be given DNA-based dietary guidelines to assess its efficacy in improving glucose regulation compared to standard dietary guidelines for people with pre-diabetes, and whether this intervention can be delivered effectively via an app. If successful, this could provide a low-cost, highly scalable prevention intervention for type 2 diabetes that would be accessible to a wider portion of the public.

Our international, cross-disciplinary team of researchers have continued to push the boundaries of biotechnology research. With researchers from 22 countries worldwide, we have benefited greatly from attracting intellect from many corners of the world. We're looking forward to another prosperous year ahead of cutting-edge research and innovation.

Professor Chris Toumazou
FRS, FEng, FMedSci,
Regius Professor of Engineering

Founding Sponsor's foreword

The Centre for Bio-Inspired Technology has continued to thrive as one of the world's leading centres for biotechnology. As a hub of intellect from the disciplines of electrical engineering, bioengineering, and neurotechnology amongst many more, researchers at CBIT are tackling some of the biggest health challenges in the world today.

In pursuit of these aims, it has been my pleasure to watch the investigators secure independent funds to continue their work and develop their research from the laboratory to the clinic. Knowledge transfer in this way has always been one of the core principles of the Centre. While translating research to medical application is a long and arduous process, it is fundamental to our fight against cancer, diabetes and obesity to name just a few of the life-threatening conditions for which the Centre is actively developing therapies.

It is therefore especially gratifying to witness so many of these projects gain critical mass to have an impact in the medical and commercial worlds. The Centre has enjoyed success in many diverse fields in this way through publications, products and spin-out companies. It is through such products that engineering and academia directly benefit society.

The breakthrough work and recognised successes of the Centre bolsters its proven track record as it continues to spearhead new initiatives for tough and pressing problems. In turn, the reputation grows and attracts more talented researchers and more funding awards to begin new and ever more ambitious projects. As this circle completes, we look forward to many more successful years of innovation in the future.

**Professor Winston Wong OBE,
BSc, DIC, PhD, DSc**



People

Academic & senior research staff

Professor Chris Toumazou FRS, FEng, FMedSci
Regius Professor of Engineering;
Director, Centre for Bio-Inspired Technology;
Chief Scientist, Institute of Biomedical Engineering;
Winston Wong Chair in Biomedical Circuits,
Department of Electrical and Electronic Engineering

Dr Timothy G Constandinou
Reader, Department of Electrical and Electronic Engineering;
Deputy Director, Centre for Bio-Inspired Technology

Dr Pantelis Georgiou
Reader, Department of Electrical and Electronic Engineering;
Head of Bio-Inspired Metabolic Technology Laboratory

Professor Chris N McLeod
Principal Research Fellow

Dr Konstantin Nikolic
Senior Research Fellow

Research staff

FELLOWS

Reza Bahmanyar, PhD

Pau Herrero Vinas, PhD

Melpomeni Kalofonou, PhD

Nishanth Kulasekeram, PhD

Yan Liu, PhD

Jesus Rodriguez Manzano, PhD

JUNIOR RESEARCH FELLOWS

Sara Ghoreishizadeh, PhD

ASSOCIATES

Mohamed El-Sharkawy, PhD

Caroline Golden, PhD

Lieuwe Leene, PhD

Kezhi Li, PhD

Chengyuan Liu, PhD

Sara de Mateo Lopez, PhD

Katarzyna Szostak

Krzysztof Wildner, PhD

Longfang Zou, PhD

Ling-Shan Yu, PhD

ASSISTANTS

John Daniels

Dorian Haci

Bernard Hernandez Perez

Khalid Mirza

RESEARCH STUDENTS

Nur Ahmadi

Miguel Cacho Soblechero

Francesca Cavallo (started October 2018)

Matthew Cavuto

Chen Chih-Han

Matthew Douthwaite

Peilong Feng

Amparo Guemes Gonzalez

Bryan Hsieh

Timo Lauteslager

Xiaoran Liu

Kenny Malpartida Cardenas

Michal Maslik

Federico Mazza

Nicholaos Miscourides

Nicolas Moser

Christoforos Panteli

Adrien Rapeaux

Oscar Savolainem

Francesca Troiani

Siwei Xie

Junming Zeng



Administrative staff

Wiesia Hsissen

Senior Group Administrator (CAS)

Gifty Kugblenu

PA to Professor Toumazou

Izabela Wojcicka-Grzesiak

Senior Research Centre Administrator (CBIT)

Visiting academics

PROFESSORS

Professor Tor Sverre Lande

University of Oslo

Professor Andrew Mason

Michigan State University

Professor Bhusana Premanode

Professor David Skellern

Formerly Macquarie University, Australia

Professor Winston Wong

Grace THW, Taiwan

Professor Sir Magdi Yacoub FRS

National Heart & Lung Institute, Harefield Hospital

Professor Patrick Soon-Shiong

Chairman of the National Coalition of Health Integration (USA)

RESEARCHERS

Dr Alison Burdett

Toumaz Group, UK

Dr Jamil El-Imad

W Investments, UK

Dr Julio Georgiou

University of Cyprus

Dr Kiichi Niitsu

Nagoya University, Japan

Dr Miguel Silveira

Sensium Healthcare Ltd, UK

Dr Themis Prodromakis

University of Southampton

Graduates in 2017–2018

Khalid Mirza

Bernard Hernandez Perez

Researchers who have taken up appointments elsewhere

Sara Ghoreishizadah

University College London

Nir Grossman

UK Dementia Research Institute, ICL

Nishanth Kulasekaram

Fujitsu UK

Song Luan

DNAudge

Huan Wang

DEPIXUS

Ian Williams

EEE Dep. ICL

Our mission: Inspired by lifestyle aspirations and biological systems, the Centre for Bio-Inspired Technology is inventing, developing and demonstrating devices to meet global challenges in engineering, science and healthcare, by effectively and efficiently mimicking living systems to create innovative and advanced technologies.

Research strategy

The Centre's research programme involves a strong combination of integrated miniature sensing with biologically-inspired, intelligent processing, through state-of-the-art semiconductor technology. We aim to make small healthcare devices, which combine electronics with biological processes. By applying conventional silicon microchip technology in new ways, we are creating new opportunities for medical device innovation.

We have pioneered next generation semiconductor sequencing (spun out and licensed internationally), developed and trialled the world's first biologically-inspired artificial pancreas for Type-1 diabetes, invented and commercialized the disposable digital plaster for healthcare monitoring (now both FDA-approved and CE-marked), and are continuing to push the envelope of how semiconductor technology is applied to biomedicine.

Such advances mean that there can be a shift in care away from a centralized model that puts the physician at its core to a smarter, more decentralized approach centred on the patient – known as personalised healthcare. They also open up new ways of coping with the huge problems of ageing populations and surges in chronic ailments such as diabetes and heart disease.

In our Centre, building a solid foundation for technological innovation through workbench engineering and fundamental scientific research is integral to our approach. Advancements at this level are crucial, not only for the enhancement and application of existing technologies and materials, but also for the discovery of new and disruptive alternatives. Research efforts at the preclinical stage then filter through to positive clinical outcomes with an agility only possible from the integrated development process found in CBIT. Innovations also flow both ways with the development of our novel technologies equipping scientists and engineers with new tools to address research questions of fundamental importance.

Researchers within the Centre for Bio-Inspired Technology also work together with other scientists and engineers from across Imperial College as well as in collaboration with partner institutions and industry. Project teams include medical researchers and clinicians to ensure the focus remains on the medical needs we aim to address. The Centre's Research Strategy is based on applying engineering technologies in innovative ways to provide personalised healthcare devices for chronic disease management. Our key activities are organized into five application-aligned technology themes: Genetic, Metabolic, Neural, Cancer, and Bio-modelling.

Genetic technology

Research focuses on the development of semiconductor based fully integrated Lab-on-Chip platforms for detection of genetic markers in applications ranging from rapid diagnostics to on-the-spot genetic testing

www.imperial.ac.uk/bio-inspired-technology/research/genetic

HEAD OF RESEARCH

Professor Christofer Toumazou

Our research focuses on the development of semiconductor based, fully integrated Lab-on-Chip platforms for the detection of genetic markers in metabolic diseases such as diabetes among others. Despite the success of many diabetes prevention programs worldwide, the number of people diagnosed with diabetes has quadrupled in the UK since 1980. The issues lie in both screening and the delivery of the intervention. In our clinical trial we are working on an intervention that will be easy-to-use, require no visits to a hospital or a dietitian, and won't even require the person to know that they are pre-diabetic.

The life expectancy in both the EU and US fell in 2015. A third of premature deaths could be prevented as obesity is one of the major contributing factors. Worldwide about 40% of adults are overweight and 13% are obese. Regulation of food metabolism is becoming one of the main issues relevant to human health today. In many instances, obesity is preventable, however currently, there are no non-invasive, cost-effective obesity treatments available, pointing to the need for novel diagnostic and prognostic tests. Leptin, a gut-hormone protein, has been shown to be crucial in regulating appetite and weight. Its concentration is proportional to the percentage of body fat of the individual, and it changes at a greater rate compared to weight loss, therefore it can be used as a key measure of diet efficiency. Strong correlation between plasma and salivary leptin levels facilitates monitoring leptin in saliva, and provides point-of-care (PoC) personalised insight into the success of individual weight loss programs.

Current projects

ASPIRE-DNA clinical trial

We are taking the rapid, sample-to-result technology that began in CBIT, and harnessing it to prevent type 2 diabetes. In the ASPIRE-DNA clinical trial, we are examining how a DNA-based diet can improve the impaired glucose regulation of individuals with pre-diabetes, compared to standard care. We are also

assessing whether this information can be given in the form of an app and a wearable to allow the DNA-based guidelines to guide the user's shopping choices when they need it. This technology combines the on-the-spot genetic testing technology developed at CBIT, with the technology of DnaNudge Ltd., a company co-founded by Prof. Christofer Toumazou, to provide the user with personalised food product recommendations that is guided by their DNA. If successful, this could provide a preventative measure for type 2 diabetes that is low-cost, easy-to-use and scalable. Moreover, members of the public could use DnaNudge technology without knowing that they are pre-diabetic. Hence, people can take active steps to prevent the onset of type 2 diabetes without even knowing that they are at risk.

The ASPIRE-DNA clinical trial is the first project under our new area of research Nudgeomics – www.imperial.ac.uk/nudgeomics. Nudgeomics combines the information in your DNA with a subtle external nudge to induce lasting behavioural change. A series of small incremental changes over time can lead to big changes towards better health. We are piloting this idea in the clinical trial by using information in an individual's DNA to guide their food shopping choices. The nudge is given in the form of a red or green light indicating whether a food product is recommended for the user or not. Whilst the aim of the clinical trial is to determine if this can be used in the prevention of type 2 diabetes, we will look at this data more broadly to see if whether following food recommendations based on your DNA, is not only reinforced by complying to the external nudge, but whether it is reinforced via an internal nudge of your body responding well to eating according to how your DNA is programmed.

We are also examining how leptin, the “hunger hormone”, may be used as an additional external nudge for making healthier food choices. Preliminary data in users following a DNA-based diet, has indicated that salivary leptin correlates with calorie intake, and shows promise in potentially correlating with the proportion of recommended (green) food products that users choose. We will be examining this further in the coming year to evaluate how this may help as a feedback mechanism for users following a DNA-based diet.



Team: Prof. Nick Oliver, Prof. Christofer Toumazou, Dr. Maria Karvela, Dr. Caroline Golden, Mrs. Maria Eze, Ms. Natalie Bosnic, Dr Pierre de Beaudrap, Ms. Judith Bedzo-Nutakor, Dr. Sara de Mateo Lopez, Dr. Khalid Baig Mirza, Ms. Francesca Cavallo

Collaborators: Prof. Nick Oliver, Department of Medicine, Imperial College London

Funding: DnaNudge Ltd

Website: www.imperial.ac.uk/nudgeomics/aspire-dna-clinical-trial/
www.dnanudge.com/

DNAsensPROT – Ultrasensitive technology to tackle food disorders

Under this Proof-of-Concept (POC) grant we will develop a technology which will lead to a better understanding of the role of hormones in appetite regulation and their impact on conditions such as obesity. In order to detect protein molecules, such as leptin, traditional protein detection techniques such as sandwich ELISA and radioimmunoassay offer high resolution, however, the nature of their workflow make point-of-care (PoC) or out-of-lab detection difficult, with complex protocols and assay times running up to four hours in a laboratory environment. Here, to overcome the above difficulties, we propose a novel salivary leptin concentration measurement technique and detection platform which quantify proteins indirectly through DNA amplification methods. The key idea (patent pending) is to amplify and quantify DNA

displaced from DNA-aptamer complexes by leptin molecules with real-time Polymerase Chain Reaction (qPCR) or Loop Mediated Isothermal Amplification (LAMP) assays coupled to Ion Sensitive Field Effect Transistor (ISFET) lab-on chip arrays.

We were recently awarded funding to further develop this technology and create a PoC platform to provide linear label-free ultrasensitive protein detection, reducing complexity, time-to-result and cost of the assay. Furthermore, the development of this novel molecular method will enable quantification of a broader number of protein targets and create one of the most sensitive PoC techniques for protein quantification, with applications far beyond appetite control (obesity, anorexia etc) management.

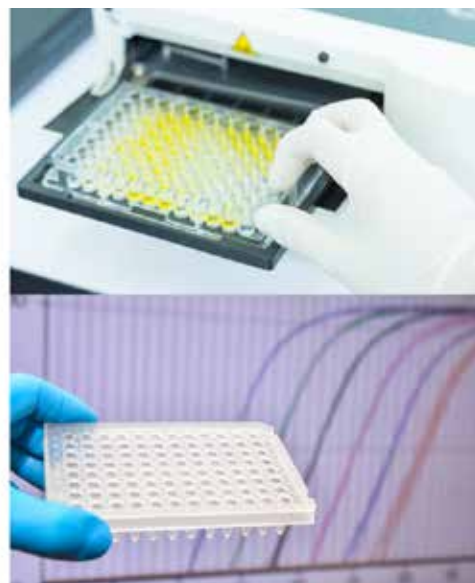
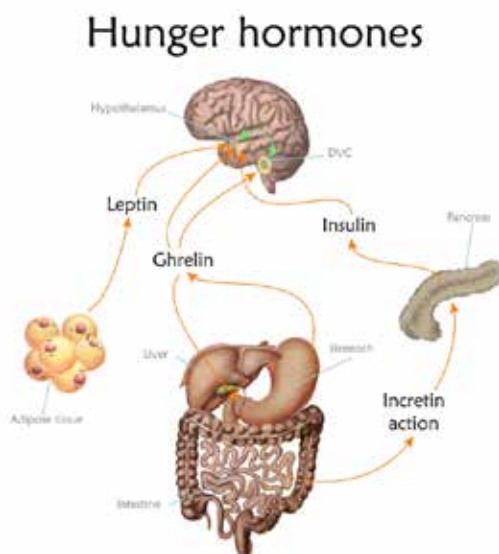

Our team: Prof. Christofer Toumazou, Dr. Konstantin Nikolic, Dr. Jesus Rodriguez Manzano, Dr. Khalid Baig Mirza, Dr. Sara de Mateo Lopez

Funding: ERC-Proof of Concept (ERC-2018-POC)

Metabolic technology

Research on developing new technologies for diagnosis and therapy of metabolic disease with the main focus on treating diabetes and its complications

www.imperial.ac.uk/bio-inspired-technology/research/metabolic

HEAD OF RESEARCH Dr Pantelis Georgiou

Recent trends in daily lifestyle and poor diet have led to an increase in metabolic disorders which are affecting millions of people worldwide. A metabolic disorder develops when organs responsible for regulating metabolism fail to carry out their operation. Diabetes mellitus, currently the most severe metabolic disease and the leading cause of mortality and morbidity in the developed world, is caused by an absolute, or relative, lack of the hormone insulin which

is responsible for homeostasis of glucose concentrations. Insulin deficiency leads to elevated glucose concentrations which, in turn, cause organ damage including retinopathy leading to blindness, nephropathy leading to kidney failure and neuropathy which is irreversible nerve damage. At least 3% of the world's population today is diagnosed with diabetes and this number is doubling every 15 years.

Our research in the Metabolic Technology Lab is focused on innovating state-of-the-art technology for the prevention and management of diabetes.



Bio-inspired Metabolic Technology research group members: 1. Pau Herrero, 2. John Daniels, 3. Vanessa Moscardo, 4. Peter Pesl, 5. Kezhi Li, 6. Amparo Guemes, 7. Mohamed El-Sharkawy, 8. Chengyuan Liu and 9. Pantelis Georgiou

Current projects

The Bio-inspired Artificial Pancreas

It is estimated that 5% of today's UK population has diabetes and it is predicted that the incidence of diabetes will continue to rise. 10% of the whole diabetes population have type 1 diabetes mellitus (T1DM), which is caused by T-cell mediated autoimmune destruction of the pancreatic beta-cells. This results in an inability of the pancreas to produce insulin in response to a glucose stimulus. If left untreated, the condition is fatal. The majority of patients with T1DM are managed in specialist diabetes clinics and are either on daily multiple subcutaneous insulin injections or continuous subcutaneous infusion of insulin via a pump.

However, there are still multiple reasons why these patients do not achieve optimal glycaemic control, including insulin resistance, non-compliance with multiple insulin injections, needle-phobia and significant hypoglycaemic (low blood glucose) episodes needing correction with carbohydrates. Poor control of diabetes is associated with long-term microvascular complications including blindness, kidney failure and nerve damage as well as macrovascular complications such as heart disease and strokes. It is well established that intensive treatment of T1DM reduces the risk of developing complications. Achieving optimal glycaemic control can be very challenging for patients with T1DM due to the increased risk of hypoglycaemia with intensive

treatment. The closed-loop insulin delivery system, also known as the artificial pancreas, has the potential to prevent hypoglycaemia and avoid large fluctuations in blood glucose levels by adjusting the insulin delivery dose frequently i.e. every 5 minutes according to the glucose concentration.

We are developing the world's first bio-inspired artificial pancreas (BiAP) for treatment of diabetes. This differs from conventional closed-loop systems in that our algorithm is based on the glucose responses of biological alpha and beta cells of the pancreas providing physiological control, in addition to being fully implemented on a miniature CMOS microchip. In doing so, it aims to offer more physiological control to subjects with type 1 diabetes, using insulin to control hyperglycaemic events and glucagon to prevent hypoglycaemia.

We have successfully validated the Bio-inspired Artificial Pancreas in adult participants with type 1 diabetes acquiring over 1000 hours of clinical data with the system and proving its safety and efficacy. Our results to date have proven the safety and efficacy of the device and we have been granted approval to begin a pivotal trial on type 1 diabetic subjects in their home environment which has started this year.



Our team: Pau Herrero, Mohamed El-Sharkawy, John Daniels, Chris Toumzaou, Pantelis Georgiou
Collaborators: Nick Oliver, Monika Reddy, Narvada Jugnee
Funding: The Wellcome Trust
Website: www.imperial.ac.uk/bio-inspired-technology/research/metabolic/bionicpancreas/

ABC4D (Advanced Bolus Calculator for Diabetes)

This research project in collaboration with DEXCOM uses continuous glucose monitoring and Case-Based Reasoning to create an adaptive bolus calculator for optimal insulin dosing recommendation. CBR is an artificial intelligence technique that tries to solve newly encountered problems by applying the solutions learned from solved problems encountered in the past. The complete integrated system consists of a commercially available smartphone that holds the novel advanced algorithm. The system requires regular updates of cases derived from retrospective blinded continuous glucose monitoring data and for this a commercially available glucose sensor will be used. Each new case includes information about the problem (e.g. capillary blood glucose, meal information and physical exercise), solution (recommended insulin dose) and outcome (blood glucose following a meal). The end-product is therefore a subject specific insulin bolus calculator that continues to improve with time.

The aim of the ABC4D is to minimise high and low glucose excursions which are associated with the complications of diabetes including blindness, kidney failure, nerve damage and cardiovascular disease.

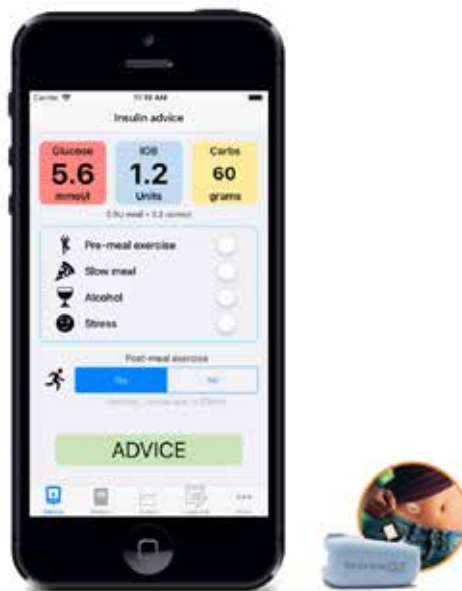

Our team: Pau Herrero, Mohamed El-Sharkawy, Pantelis Georgiou
Collaborators: Nick Oliver, Monika Reddy (ICL), DEXCOM
Funding: DEXCOM
Website: www.imperial.ac.uk/bio-inspired-technology/research/metabolic/abc4d/

PEPPER (Patient empowerment through Predictive PeRsonalised decision support)

PEPPER is a EU-funded project (H2020) aiming to develop a personalised decision support system for chronic disease management that will make predictions based on real-time data in order to empower individuals to participate in the self-management of their disease.

The design will involve users at every stage to ensure that the system meets patient needs and raises clinical outcomes by preventing adverse episodes and improving lifestyle, monitoring and quality of life. Research will be conducted into the development of an innovative adaptive decision support system based on case-based reasoning combined with predictive computer modelling. The tool will offer bespoke advice for self-management by integrating personal health systems with broad and various sources of physiological, lifestyle, environmental and social data. The research will also examine the extent to which human behavioural factors and usability issues have previously hindered the wider adoption of personal guidance systems for chronic disease self-management. It will be developed and validated initially for people with diabetes on basal-bolus insulin therapy, but the underlying approach can be adapted to other chronic diseases.

There will be a strong emphasis on safety, with glucose predictions, dose advice, alarms, limits and uncertainties communicated clearly to raise individual awareness of the risk of adverse events such as hypoglycaemia or hyperglycaemia. The outputs of this research will be validated in an ambulatory setting and a key aspect will be innovation management. All components will adhere to medical device standards in order to meet regulatory requirements and ensure interoperability, both with existing personal health systems and commercial products. The resulting

architecture will improve interactions with healthcare professionals and provide a generic framework for providing adaptive mobile decision support, with innovation capacity to be thereby increasing the impact of the project.

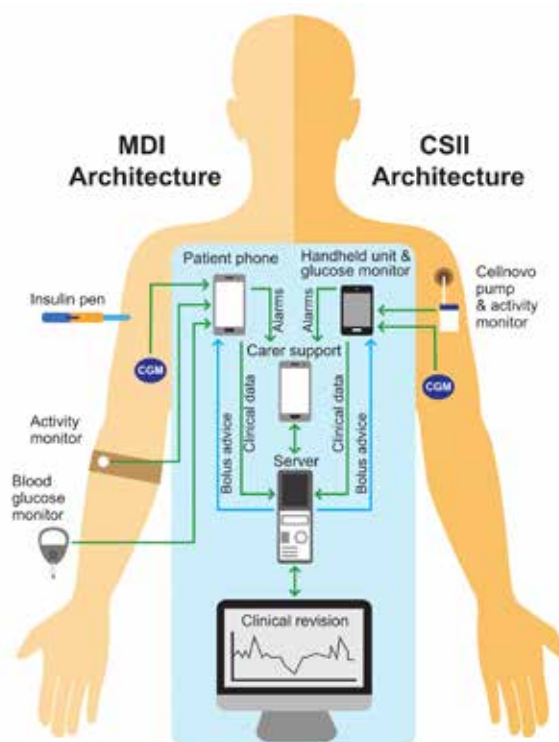

Our team: Pau Herrero, Chengyuan Liu, Pantelis Georgiou
Collaborators: Cellinovo, Romsoft, Oxford Brookes
Funding: H2020
Website: www.pepper.eu.com/Project

ARISES (An Adaptive, Real-time, Intelligent System to Enhance Self-care of chronic disease)

ARISES is an EPSRC-funded project aiming to develop a novel mobile framework that is able to intelligently collect data from an individual and facilitate a timely intervention to manage chronic disease through therapeutic and life-style recommendation.

As an exemplar case to demonstrate the ARISES system we have chosen the management of type 1 diabetes. The system will promote the self-management of diabetes by optimizing glucose control through insulin dosage recommendation (therapeutic advice) and exercise and physical activity support (heart rate, skin temperature, ambient temperature, etc.), carbohydrate recommendation to prevent hypoglycaemia, and behavioral change through education (lifestyle advice). Recently continuous glucose monitors have also been linked to these applications and are able to provide real-time biological data to inform people with diabetes of their historical glucose trends.

In this work we will use a machine learning (ML) framework as an adaptive, real-time decision support system to run locally a smartphone without the need for an internet connection. A deep neural network (DNN) will be adopted in extracting essential features from our dataset; and long short-term memory (LSTM), a recurrent neural network (RNN) architecture will be leveraged to make the glucose time-series predictions and the hypoglycaemia/hyperglycaemia classifications. Patient safety systems will also be embedded within and security will be guaranteed by compliance to standards. The end-to-end solution will be optimised for power consumption to allow maximum use in a free-living environment.

A user interface will be designed that is intuitive and easy to use, which will be optimised by considering end-user requirements from the patient focus groups and usability pilot studies. With focus groups of patients with diabetes, a prototype user interface will be designed with standard HCI methods using feedback implemented on the wearable technology and smartphone. The interface will then be iteratively improved through monthly focus groups. The optimised visualization tool will be validated, and final usability will be quantified by gathering patient feedback.

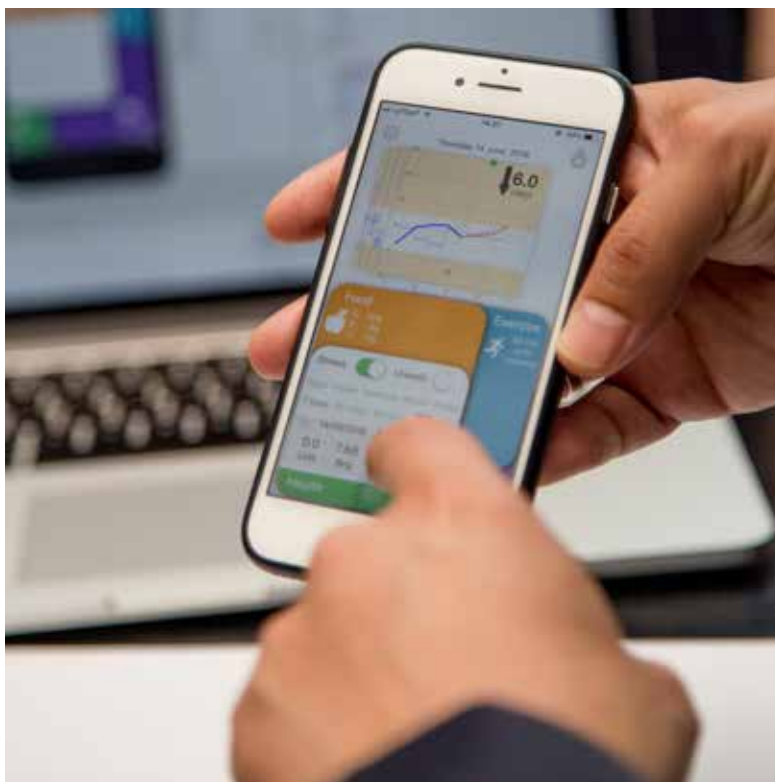
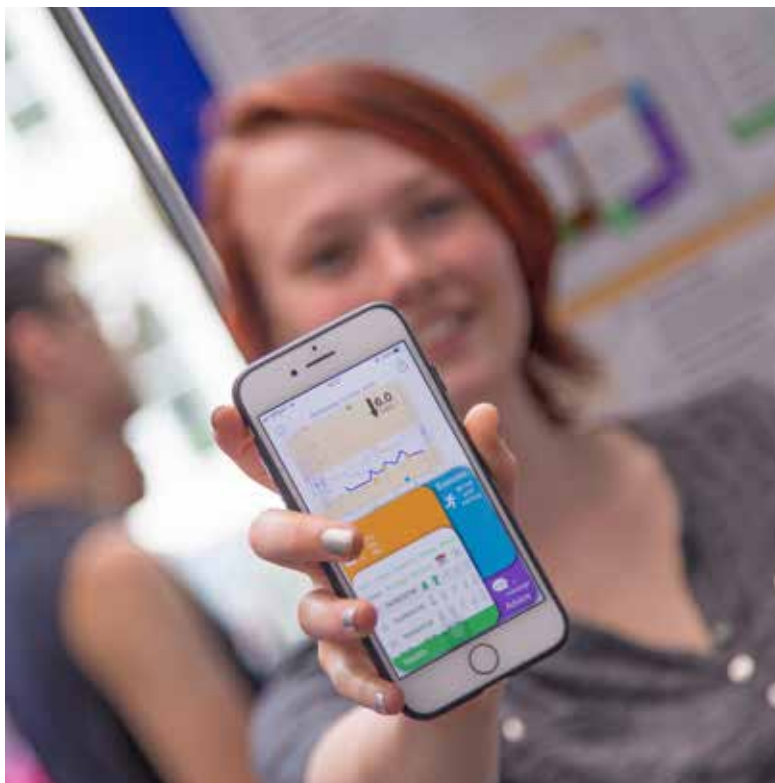

Our team: Kezhi Li, John Daniels, Pau Herrero, Bob Spence, Pantelis Georgiou
Collaborators: Nick Oliver, Chukwuma Uduku (ICL NHS Trust), Dexcom, ICONplc
Funding: EPSRC

Cancer technology

Development of cancer diagnostic sample-to-result microchip based prototypes that will assist in risk stratification and optimization of cancer treatment at the early and advanced diagnostic stage

www.imperial.ac.uk/bio-inspired-technology/research/cancer-technology

HEAD OF RESEARCH

Professor Christofer Toumazou

Our research at the Centre for Bio-Inspired Technology is focused on the application of microchip based sensing technologies for early screening, detection and monitoring of cancer markers, with the ultimate goal being the development of systems assisting at the point of need aiming for the personalization of cancer therapy. Primary focus is on the areas of breast cancer monitoring and particularly on liquid-biopsy diagnostics (Mi-CARE) as well as on the field of epigenetic monitoring of cancer.

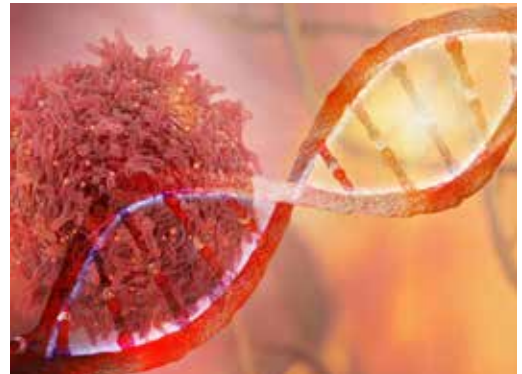

Current projects

Development of a novel method for quantification of DNA methylation in cancer patients

Furthering the application of genetic technology in medicine, our research also focuses on the role of epigenetic markers and specifically the role of DNA methylation in prediction and monitoring of cancer. DNA methylation is a widely applied epigenetic biomarker, a chemical tag that can modify the genetic function and regulatory mechanisms of gene expression. It has been extensively applied in the field of cancer with previous work at the Centre to have led in the development of an ISFET based pH-mediated Lab-on-Chip platform for detection of DNA methylation ratio in well-studied cancer markers.

This project supported by the EPSRC Impact Acceleration Award in collaboration with the Epigenetics Unit at the Department of Surgery and Cancer, Imperial College London, focuses on the development of novel molecular methods based on isothermal nucleic acid amplification chemistries for the quantification of DNA methylation of several cancer-related gene regions, including chemotherapy responsive markers for ovarian cancer. The nature of these assays, in combination with our microchip diagnostic technology, will enable the creation of fully integrated systems to be implemented in the clinic to provide personalized treatment in cancer patients. This will generate a tremendous impact on the current diagnostic approach of cancer patients by combining the ease of use, low cost and scalability that microchip technology is offering while assessing cancer risk, monitoring tumour progression, predicting treatment response and evaluating patient prognosis through the analysis of cancer specific epigenetic changes in blood samples.

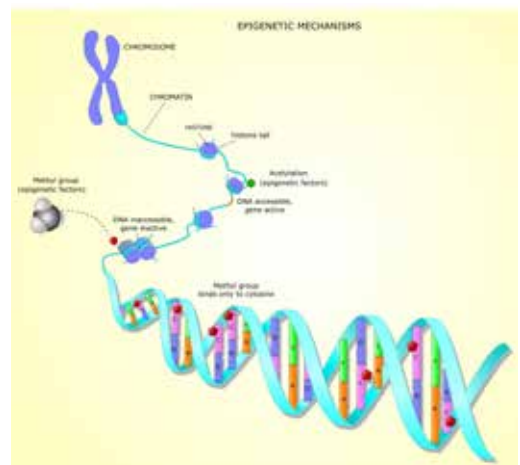

Our team:

Prof. Chris Toumazou, Dr Melpomeni Kalofonou, Dr Sara de Mateo Lopez

Collaborators:

Dr James Flanagan (Epigenetics Unit, Dept. of Surgery & Cancer, Imperial College London).

Early detection and therapeutic monitoring of breast cancer (Mi-CARE)

In the UK, the majority of patients with breast cancer have no evidence of metastases at the time of diagnosis. Although surgery is capable of removing the primary cancer, in many patients, cancer cells can seed throughout the body forming micrometastases, not detectable through screening tests. These often persist despite medical treatment given after surgery and can grow and spread over time if left unchecked. Detecting early the presence of micrometastases before relapse occurs is of great importance as it will allow treatment to be tailored to the patients' clinical profile.

To date, a number of lab-based tests have been developed, primarily for diagnostic purposes, requiring tissue biopsies which are often difficult to obtain and may not be fully representative of the disease due to its inherent intratumoral heterogeneity, or are focusing on NGS methods, which are of high cost and require processing power to analyse genome-wide sequencing data. In contrast, a blood based test or 'liquid biopsy' has the potential to detect tumour specific genetic markers found in blood circulation, in a minimally invasive way. Such test could predict the risk of relapse and could be repeated over the course of treatment to monitor drug response and disease progression. This would enable the realization of a more 'curative', well-stratified, patient-centric therapy model.

This project, supported by the CRUK Multidisciplinary Award and the EPSRC, is in collaboration with Prof Charles Coombes (Department of Surgery and Cancer, Imperial College London) and Prof Jacqui Shaw (Department of Cancer Studies, University of Leicester), whose research has shown that tumour specific mutations in circulating free DNA (cfDNA) found in blood plasma, can be used as biomarkers for detection and monitoring of breast cancer progression (from first diagnosis to follow-up), with the potential to differentiate between the period of cancer dormancy and of minimal residual disease. On the basis of this clinically validated work, our research in the Centre involves the development of a microchip-based, sample-to-result, scalable Lab-on-Chip system consisting of arrays of ISFET sensors, which in combination with microelectronics and information processing units will provide a fast and of low-cost solution for early detection of recurrence through precision screening and therapeutic monitoring of the disease.

Related articles:

www.imperial.ac.uk/news/184151/electrical-engineers-advancing-cancer-diagnostics

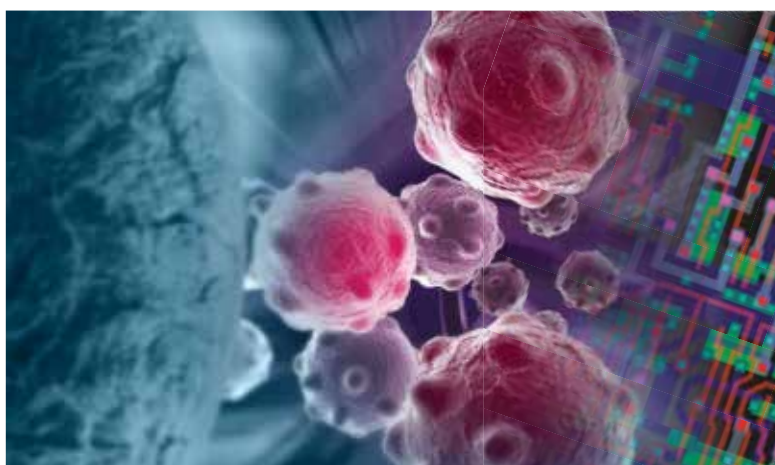

Our team: Prof. Chris Toumazou, Dr Melpomeni Kalofonou

Collaborators: Prof. Charles Coombes (Dept. of Surgery & Cancer, Imperial College London), Prof. Simak Ali (Dept. of Surgery & Cancer, Imperial College London) and Prof. Jacqui Shaw (Dept. of Cancer Studies, University of Leicester)



Bio-modelling

We develop methods and computational tools for understanding, modelling and simulating various biological and physiological processes and their applications in bio-inspired electronic systems

www.imperial.ac.uk/bio-modelling

HEAD OF RESEARCH

Dr Konstantin Nikolic

Dr Nikolic leads the Bio-modeling group at the CBIT, which develops methods and computational tools for understanding, modelling and simulating various biological and physiological processes and their applications in bio-inspired electronic systems. Bio-modelling tries to capture the complexity of biophysical, biochemical and bioinformatic processes at different scales, from individual molecules to complete organisms, in relatively simple models. These models and computational simulations provide useful insights, and represent a fundamental basis in understanding how to design new bio-inspired devices.

Current projects

Computational Optogenetics

Prometheus – A publically available web Portal for Computational Neuroscience along with a Graphical User Interface. It provides the tools for computational optogenetics (PyRhO) together with the NEURON and Brian2 platforms available with no installation or configuration, eliminating all related potential frustrations to users, especially those with a limited computational background. The portal is currently hosted on the Digital Ocean cloud infrastructure: <http://try.projectpyrho.org>.

Research team: Benjamin Evans.

Funding: BBSRC Impact Acceleration Award and EPSRC Platform Grant '*Disruptive Semiconductor Technologies for Advanced Healthcare Devices*'.

PyRhO – Multiscale Computational Platform for Optogenetics.

The module is written in Python with an additional IPython/Jupyter notebook based GUI, allowing models to be fit, simulations to be run and results to be shared through simply interacting with a webpage. The model fitting algorithms are seamlessly integrated with simulation environments, including NEURON and Brian2.

Research team: Benjamin Evans.

Funding: BBSRC – '*Multiscale Computational Tools for Optogenetics*'

Neuronal gain modulability.

Research team: Dr Sarah Jarvis, Collaboration: Prof Simon Schultz (Department of Bioengineering)

Funding: Wellcome Trust Institutional Strategic Support Fund (ISSF) – '*Network of Excellence: for Optogenetic Manipulation of Injured Neural Tissue*'.

Neuromorphic systems

Combining several neuromorphic devices, such as Dynamic Vision Sensor ('the eye'), SpiNNaker board (spiking neural networks simulation platform – 'the brain') and a servo ('the hand') into a robotic system, for completing simple cognitive tasks with sensory inputs, such as robot goalie.

Research team: Benjamin Evans, Faustine Ginoux.

Collaboration: Prof Tobi Delbruck (INI, Zurich) and Prof Steve Furber (Manchester).

Funding: EPSRC Platform Grant

Neurotechnology (Modelling and Computational Neuroscience)

For a number of years we have been developing a new generation of neural interfaces that combine novel electrode materials, structures and sensing modalities with low power electronic neural recording, analysis, stimulation and wireless communication. The key element of the developed device is the algorithm for the closed-loop regulation of the stimulation dosage.

Research team: Khalid Mirza, Krzysztof Wildner, Nishanth Kulasekeram.

Funding: ERC, Project: 'izMOVE – Intelligent Implantable Modulator of Vagus Nerve function for treatment of obesity'.

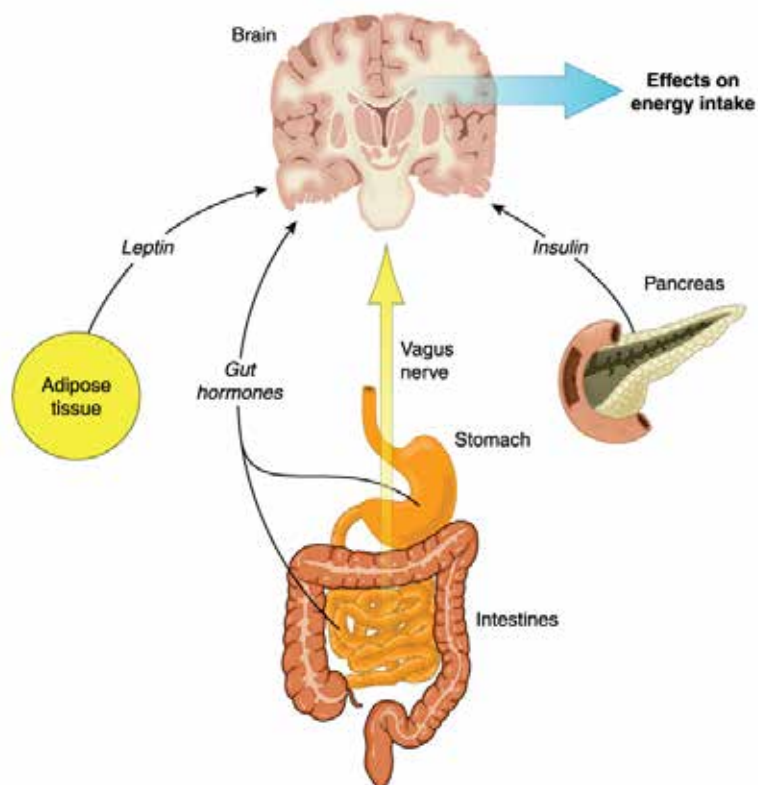

Machine Learning

Cancer Breathalyser – Development of a machine learning algorithm for a breathalyser device for cancer diagnostics. The project also includes a statistical analysis of the volatile organic compounds concentrations in the exhaled breath for searching for markers for different types of cancers.

Research team: Benjamin Evans. Collaboration: Prof George Hanna and Dr Sheraz Markar (Surgery and Cancer, Department of Medicine).

Funding: Wellcome Trust ISSF – 'Network of Excellence for development of Point-of-Care Breath Analysing device for cancer diagnostics' and EPSRC Platform Grant.

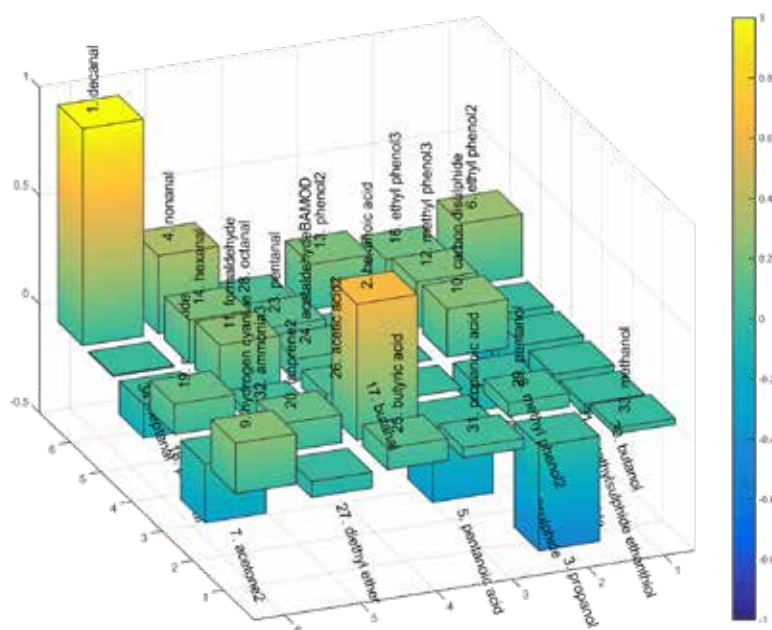

Assessment of non-invasive exhaled breath test for the diagnosis of oesophagogastric cancer. Volatile Organic Compound (VOC) breath model of OE cancer: Graphical illustration of changes in all VOCs between study groups (163 had cancer and 172 were in control group). Positive deflection indicated an upregulation in the cancer group and a negative deflection indicated a downregulation in the cancer group relative to the non-cancer group.

Infection technology

Research on developing cutting edge technologies and innovative molecular methods for rapid and accurate diagnosis of infectious diseases and antimicrobial resistance at the point-of-care

www.imperial.ac.uk/bio-inspired-technology/research/infection-technology

HEAD OF RESEARCH

Dr Pantelis Georgiou

Infectious diseases and antimicrobial resistance (AMR) seriously endanger individual and global health, especially among low- and middle-income countries (LMIC). Worldwide monitoring of emergent and re-emergent pathogens and new genetic variants is currently lacking. Analysis is limited to centralised laboratories, which are dispersed relative to the geographic spread of the population at risk. These geographic gaps impact the treatment of individual people (i.e. delayed treatment, poor patient follow-up) and influence (i) control of the spread of pathogens; (ii) early detection of new strains; (iii) drug resistance assessment; and (iv) understanding of vaccine

performance and development. Genetic diversity within pathogens requires high-complexity molecular tests and therefore represents a major challenge for point-of-care diagnostics. These problems remain unsolved due to the absence of simple platforms for pathogen detection and typing that can be deployed in limited-resource settings, such as LMIC and in clinics, doctors' offices or airports.

Our research in the Infection Technology Lab is focused on innovating state-of-the-art technology and molecular methods for the diagnostic and management of infectious diseases and antimicrobial resistance.

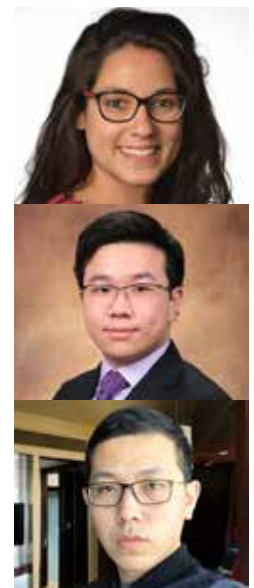

CBIT Bio-Team research group members: Ben Wormald, Melpomeni Kalofonou, Matthew Douthwaite, Jesus Rodriguez Manzano, Ahmad Moniri, Sara de Mateo Lopez, Nicholas Miscourides, Bernard Hernandez Perez, Miguel Cacho Soblechero, Kenny Malpartida Cardenas, Sara Ghoreishizadeh, Nicolas Moser, Ling-Shan (Betty) Yu, Ivana Pennisi, Anselm Au, Junming Zeng and Pantelis Georgiou.

Current projects

Next generation diagnostics for rapid discrimination of emerging and re-emerging pathogens at the point-of-care using Ion-FET digital Quantification on CHIP (IQ-CHIP)

This project combines cutting-edge technology and nucleic acid-based molecular methods to develop quantitative rapid, sample-to-answer tests able to diagnose emerging infectious diseases at the point-of-care. Our approach relies on ultrasensitive and precise nucleic acid amplification chemistries (such as loop-mediated isothermal amplification, LAMP) coupled to pH-sensing complementary metal-oxide-semiconductor (CMOS) technology. We aim to lay the foundations for addressing the global challenge of viral, parasitic and fungal infections via the development of integrative and innovative diagnostic technologies compatible with a wide range of healthcare settings for developing countries. This project explores novel alternative technologies for detection, analysis and computation of dengue, malaria and aspergillosis.

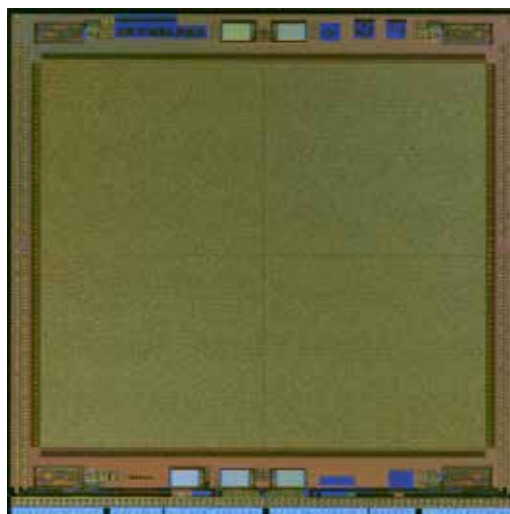

- Team:** Jesus Rodriguez Manzano, Kenny Malpartida Cardenas, Ling-Shan Yu (Betty), Chiara Cicatiello, Nicolas Moser, Nicholas Miscourides and Pantelis Georgiou
- Collaborators:** (i) **Dengue:** Sophie Yacoub (OUCRU-Vietnam), Alison Holmes (ICL NHS Trust), Prida Malasit, Panisadee Avirutnan (Siriraj Hospital, Mahidol University, Thailand), Sheng-Fan Wang and Yen-Hsu Chen (Kaohsiung Medical University, Taiwan); (ii) **Malaria:** Jake Baum (ICL, Department of Life Sciences) and Aubrey Cunnington (ICL NHS Trust); (iii) **Aspergillus:** Matthew Fisher (ICL, School of Public Health) and Darius Armstrong James (ICL NHS Trust).
- Funding:** Imperial Confidence in Concept

Development of an RNA-based test for accurate diagnosis of bacterial infection in children

A reliable diagnostic point-of-care test that identifies patients with bacterial or viral infection would have an immense impact on patient care. It would reduce unnecessary hospital admissions, invasive investigations and healthcare costs, and contribute to the reduction in antibiotic resistance by better regulating treatment with antibiotics. Our approach, which focuses on recognition of the distinct host transcriptomic responses underlying different infections, rather than identification of the pathogen, represents a paradigm shift in the diagnostic field. This project aims to provide proof of principle that bacterial infections can be distinguished from viral illness by small numbers of transcripts detected in the patient's blood, and deliver a prototype device using state-of-the-art technology, that can be used in clinical settings. It constitutes the first effort to identify bacterial disease by measuring the transcriptomic host response using lab-on-chip technology. It will be made possible by cutting-edge breakthroughs in the fields of bioinformatics and bioengineering, and will capitalise on the availability of the medical team's unique biobank of carefully phenotyped blood samples from children with bacterial and viral diseases. Our proposal will move our exciting findings, that bacterial infection can be identified by measuring RNA biomarkers in blood, towards a clinical test.

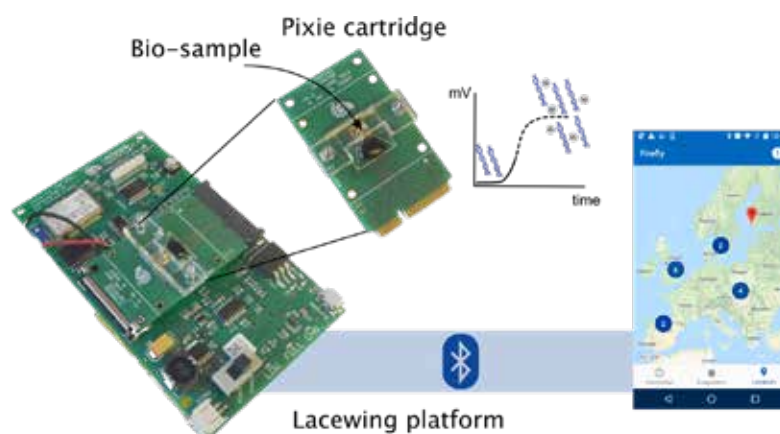

- Team:** Jesus Rodriguez Manzano, Ivana Pennisi, Nicholas Miscourides, Kenny Malpartida Cardenas, Anselm Au, Ling-Shan Yu (Betty), Nicolas Moser and Pantelis Georgiou
- Collaborators:** Myrsini Kaforou, Jethro Herberg and Michael Levin (ICL, Department of Medicine)
- Funding:** Rosetrees Trust
- Website:** www.rosetreestrust.co.uk/blog/congratulations-to-cambridge-university-and-imperial-college-london/

Validation of Biomarkers of Paediatric Tuberculosis and further development for use in Diagnosis of childhood Tuberculosis

The diagnosis of tuberculosis (TB) (both pulmonary and disseminated forms) in children is extremely difficult as current tests rely on culture of the causative bacteria from sputum or gastric aspirates. Culture of *Mycobacterium tuberculosis* may take several weeks and obtaining appropriate samples from young children is difficult. Even with the best available current methods a definitive diagnosis of childhood TB is only achieved in 20–30% of children clinically diagnosed as having TB. Lack of accurate and rapid diagnostic tests results in delayed treatment for many children, and conversely over-treatment of children who may not actually have TB is also common. There is thus an urgent need for improved diagnostic tests for childhood TB. As an alternative to detecting the causative *Mycobacterium*, identification of changes in blood proteins or the pattern of activation of genes in blood cells (protein or gene signatures or biomarkers) is a promising method for diagnosing many infections. The members of our consortium have previously studied well-characterised large groups of children with TB, and a range of other infections with similar symptoms to childhood TB. We have identified candidate protein and gene “signatures” which may be useful in the diagnosis of childhood TB. This project aims to take forward six promising protein and gene signatures (three based on proteins and three based on changes in expressed genes) for further validation in well-established cohorts of children with suspected TB in four African countries which have high burdens of childhood TB (South Africa, Malawi, Kenya and The Gambia). Using available samples from over 4,000 well characterised child TB suspects, each of the six candidate biomarkers will be validated first using the same technology as used to detect the original

biomarker and then using simpler technology which enables large numbers of patients to be analysed. In order to translate promising biomarkers to clinical tests which can be applied even in resource poor settings we will use novel technology to detect the protein and gene signatures which will be validated as the basis of a novel diagnostic test.

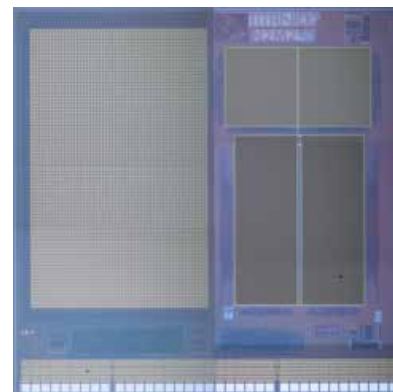
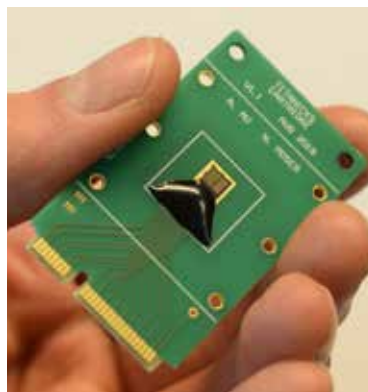

Team: Jesus Rodriguez Manzano, Ivana Pennisi, Nicolas Moser, Nicholas Miscourides and Pantelis Georgiou

Collaborators: Michael Levin, Sandra Newton, Victoria Wright, Ashleigh Cheyne, Sara Hourmat, Paul Langford, Melissa Shea Hamilton, Marcia Ivonne Peña Paz, Myrsini Kaforou and Ortensia Vito (ICL, Department of Medicine); Beate Kampmann and Toyin Omotayo Togun (MRC Unit, The Gambia & London School of Hygiene and Tropical Medicine); Mark Nicol (University of Cape Town); Heather Zar and Brian Eley (Red Cross War Memorial Children’s Hospital), Gerhard Walzl and Novel Chegou (University of Stellenbosch); Paul Corstjens, Annemieke Geluk and Tom Ottenhoff (Leiden University)

Funding: National Institute of Health (NIH)

Website: www.tbmarkers.nih.com

Multiplex discrimination of antimicrobial resistance genes using novel multidimensional standard curves: Addressing the NHS carbapenemase-producing Enterobacteriaceae challenge

Fast and accurate diagnosis of antibiotic-resistant organism carriage is crucial for infection prevention and control and bed management. Conventional diagnostic techniques are often too laborious and time-consuming. Multiplexed nucleic acid-based diagnostics have significant sensitivity, cost and turnaround time advantages, increasing the throughput and reliability of results. This project validates and delivers a new methodology that extends the use of real-time PCR data obtained by common qPCR instruments already in use in the NHS and thus may be readily introduced into NHS laboratories delivering real impact. This project enables, for the first time, accurate and reliable qPCR multiplexing employing only a single-fluorescence channel without post-PCR analysis. Our aim is to develop a multiplex assay associated with resistance to β -lactams which can be immediately incorporated to the routine clinical pipeline within the NHS, representing a game-changer in the AMR field.

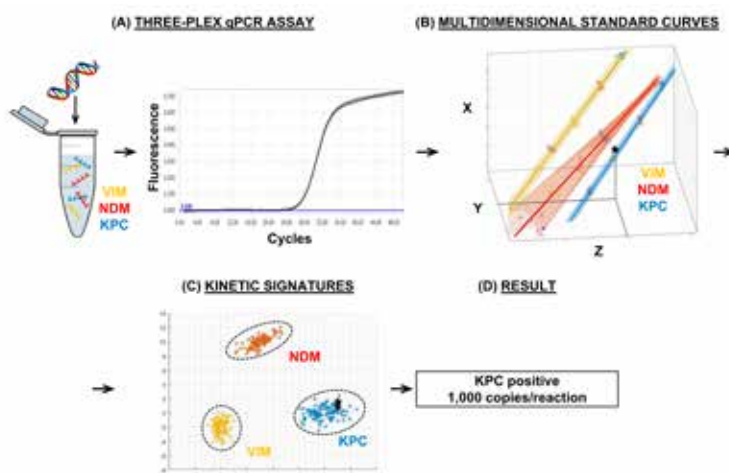

Team: Jesus Rodriguez Manzano, Ahmad Moniri and Pantelis Georgiou
Collaborators: Alison Holmes and Frances Davies (ICL NHS Trust)

Funding: Imperial Techcelerate programme

Website: www.imperial.ac.uk/enterprise/staff/techcelerate/cohort-two---current-projects/

IC-REACT (Imperial College Real-Time Enhanced Antimicrobial ConTroller)

The IC-REACT project investigates a novel method for precision antimicrobial delivery utilising a closed-loop control system integrating a subdermal antimicrobial sensor. This allows real-time assessment of antimicrobial levels to guide a closed-loop controller, which optimises the delivery of antimicrobial agents through direct communication and adjustment of an infusion pump. Inappropriate dosing of patients with antibiotics is a driver of antimicrobial resistance, toxicity, and poor outcomes of therapy. In this project, we hypothesise that the use of a closed-loop system will improve the attainment of pharmacokinetic-pharmacodynamic targets for antimicrobial therapy in patients receiving treatment across secondary care, where wide variations in target attainment have been reported, including those in critical care, obese, and those with renal disease. The study will focus on critical antimicrobials, such as the beta-lactams (penicillins, cephalosporins, and carbapenems), polymyxins, glycopeptides, aminglycosides, and antifungal agents, such as the azoles. The exact target agents will be selected based on current problem areas within the study site closer to the time of study commencement to allow adequate recruitment.

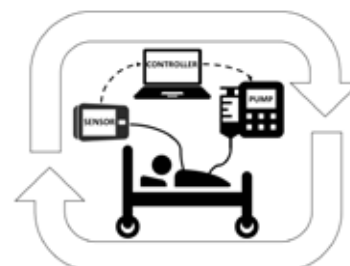

Team: Pau Herrero, Bernard Hernandez and Pantelis Georgiou
Collaborators: Alison Holmes, Timothy Rawson (ICL NHS Trust), Danny O'Hare (ICL, Department of Bioengineering) and Tony Cass (ICL, Department of Chemistry)
Funding: BRC

EPIC-IMPOC

(enhanced, personalized and integrated care for infection management at the point-of-care)

Infectious diseases are caused by the invasion of pathogenic microorganisms such as bacteria, viruses or fungi and are one of the leading causes of mortality worldwide. In the last years, there has been a significant increase in the ability of these microorganisms to resist antimicrobials which were previously effective. This phenomenon, denoted as antimicrobial resistance, has become a noticeable obstacle to treat infections in health care with misuse and overuse of antimicrobials as one of the leading drivers.

This project presents a novel clinical decision support system for infection management to provide personalized, accurate and effective diagnostics at the point-of-care. The proposed system incorporates two main decision support engines: case-based reasoning to facilitate vital sign collection, patient monitoring and further inspection of past similar cases and probabilistic inference to provide stepwise guidance within the infection management pathway followed by clinicians. In addition, a number of local AMR statistics are automatically computed from susceptibility test data to promote education and awareness among clinicians. All these elements combined result in a state-of-the-art clinical decision support system which assists physicians on multiple areas within infection management to facilitate the provision of evidence-based and personalized medicine.

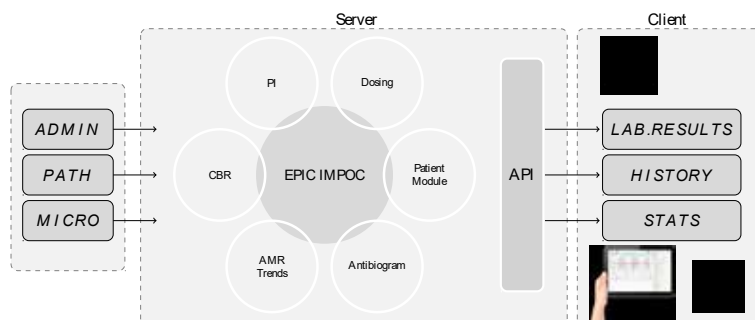

Team: Pau Herrero, Bernard Hernandez, Chris Toumazou and Pantelis Georgiou
Collaborators: Alison Holmes, Timothy Rawson, Luke Moore, Esmita Charani, Julliet Allibone (ICL NHS Trust)
Funding: NIHR i4i
Website: www.imperial.ac.uk/bio-inspired-technology/research/infection-technology/epic-impoc/

Neural technology

Innovating neurotechnologies to enable new capabilities in scientific research, and medical devices (implantable and wearable) to improve medical care and quality of life for individuals with neurological conditions such as epilepsy, spinal cord injury, paralysis and sensory impairment.

www.imperial.ac.uk/neural-interfaces

HEAD OF RESEARCH
Timothy Constandinou, PhD

We are now entering a tremendously exciting phase in our quest to understand the human brain. With large-scale programmes like the US Presidential BRAIN Initiative, EU Human Brain Project, Japanese Brain/MINDS, China Brain Project, etc, there is currently a huge appetite for new neurotechnologies. There is also, more recently a concerted effort (e.g. Galvani Bioelectronics, NIH SPARC, DARPA HAPTIX) on electroceuticals – bioelectronic devices that target individual nerve fibres within the peripheral nervous system to treat an array of conditions.

We have already witnessed the impact made by devices such as cochlear implants and deep brain stimulators, with hundreds of thousands of individuals that have and are benefitting every day. Soon, similar assistive technology will emerge for the blind, those suffering from epilepsy, and many others.

Electroceuticals will furthermore provide targeted therapy to a range of conditions that have not normally been associated with the nervous system. These could range from allergies, migraines, asthma and obesity

all the way up to hypertension, infertility and possibly even cancer.

With the current capability in microtechnology, never before have there been so many opportunities to develop advanced devices that effectively interface with the nervous system. Such devices are often referred to as neural interfaces, or brain-machine interfaces, and range from wearable systems to fully implantable devices. Neural prostheses use such interfaces to bypass dysfunctional pathways in the nervous system, by applying electronics to replace lost function.

Our research at the Centre for Bio-Inspired Technology (CBIT) and Next Generation Neural Interfaces (NGNI) lab is aimed, ultimately at developing such assistive technology by exploiting the integration capability and scalability of modern semiconductor technology. We are working on addressing key technology challenges such as scalability, selectivity, signal conditioning and processing, bandwidth optimization, energy efficiency, power delivery, wireless connectivity, miniaturization, biocompatibility, packaging. These will serve to ensure end devices are safe, effective and secure.



Microphotograph of a recent multi-project reticle including 20+ different implantable neural microsystem designs for CANDO, SenseBack, ENGINI and NGNI projects. Stylised with neuronal overlay.

Current projects

CANDO – Controlling Abnormal Network Dynamics using Optogenetics

This is a world-class, multi-site, cross-disciplinary project to develop a cortical implant for optogenetic neural control in patients with focal epilepsy.

In the brain, nerve cells generate rhythmic activity or 'brain waves'. In many neurological diseases these rhythms are disrupted, producing abnormal patterns of activity. In epilepsy, abnormal activity can often be localised to a small 'focus', which then spreads causing a seizure. Epilepsy affects 600,000 people in the UK and uncontrolled seizures have devastating effects on patients' lives. Nearly a third of cases fail to respond to conventional drug treatments and may require surgical removal of the focus. However, surgery may not be suitable for all patients due to irreversible damage to necessary brain functions.

This project proposes an alternative treatment using a small implant to modulate abnormal activity and so prevent seizure development. The implant provides precisely timed stimulation by continuously monitoring brain waves via implanted electrodes and modifying them via implanted light sources. This requires that some cells within the focus are genetically altered using a safe virus to make them sensitive to light. Over seven years the project will progress through several phases. Initial phases focus on technology design and development, followed by rigorous testing of performance and safety. The aim is to create a first-in-human-trial in the seventh year in patients with focal epilepsy.

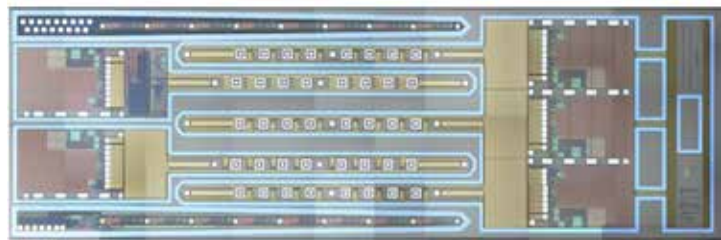

Our team: Dorian Hacı, Yan Liu, Timothy Constandinou
Collaborators: Newcastle University, UCL and Newcastle Hospitals NHS Foundation Trust
Funding: Wellcome Trust/EPSC Innovative Engineering for Health
Website: www.imperial.ac.uk/neural-interfaces/research/projects/cando/
www.cando.ac.uk

ENGINI – Empowering Next Generation Implantable Neural Interfaces

Brain Machine Interfaces (BMIs) have a genuine opportunity to affect a transformative impact on both medical and non-medical applications. More specifically, clinical translation can lead to the restoration of movement and communication in patient populations with tetraplegia, amyotrophic lateral sclerosis, locked-in-syndrome, and speech disturbances.

The major technical challenges with state-of-the-art BMI technology are chronic reliability (device longevity, recording stability, calibration/training) and scalability (extending number of recording sites). Wireless capability in particular is crucial, but brings on its own set of challenges (transfer efficiency, data throughput).

Our vision is that to achieve a fundamental advance in capability, neural interfaces need to be significantly smaller, distributed across multiple devices, each being autonomous and fully wireless. ENGINI is developing a new breed of mm-scale neural microsystems that directly tackle the grand challenges of long term stability, energy efficiency, and scalability towards a truly scalable solution.

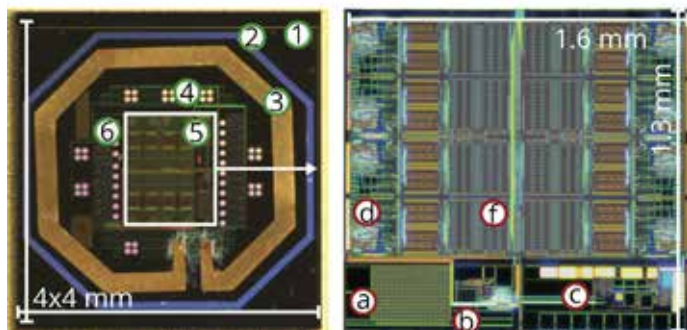
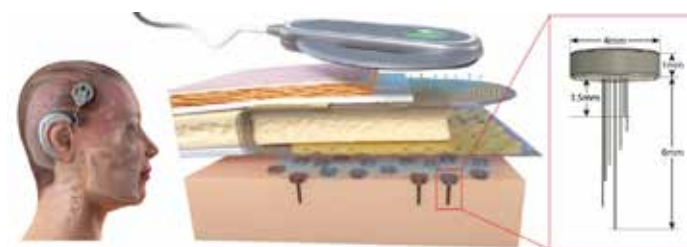

Our team: Nur Ahmadi, Matthew Cavuto, Peilong Feng, Lieuwe Leene, Michal Maslik, Federico Mazza, Oscar Savolainen, Katarzyna Szostak, Timothy Constandinou
Collaborators: Andrew Jackson (Newcastle University), Nick Donaldson, Jinendra Ekanayake (UCL)
Funding: EPSRC Early Career Fellowship
Website: www.imperial.ac.uk/neural-interfaces/research/projects/engini/

FORTE – Functional Oxide Reconfigurable Technologies

Our vision is to rejuvenate modern electronics by developing and enabling a new approach to electronic systems where reconfigurability, scalability, operational flexibility/resilience, power efficiency and cost-effectiveness are combined. Our strategy is to break out of the large, but comprehensively explored realm of CMOS technology upon which virtually all modern electronics are based; consumer and non-consumer alike.

Our aim is to integrate memristive primitives within mainstream CMOS technology. Memristors, a simpler and smaller alternative to the transistor, are low-energy, and with their capability of altering resistance and storing multiple memory states – could potentially result in computers that switch on and off instantly and never forget.

Packing more computational power in increasingly smaller areas and at ever lower power costs will unlock possibilities for applications including smart medical implants, distributed memory for machine learning and neuromorphic electronics. We plan to develop and disseminate the core technology and design tools to the research community within three years, and then focus on application demonstrators – in wide collaboration with the international research community.

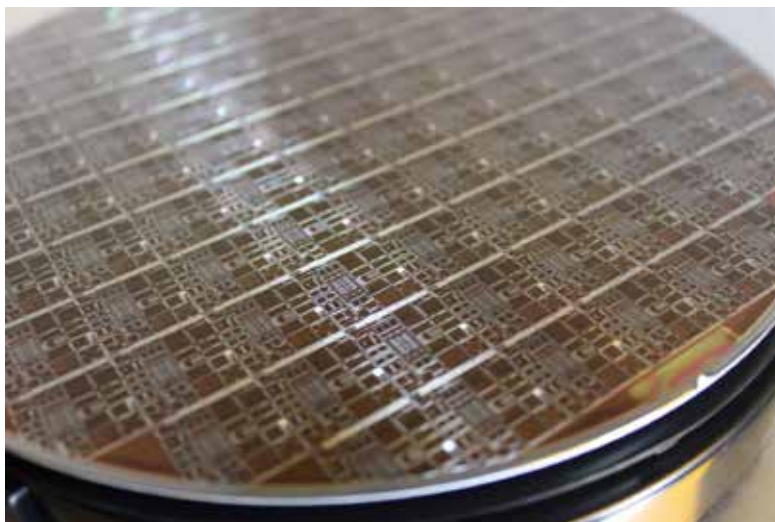

Our team: Lieuwe Leene, Jakub Szypicyn, Christos Papavassiliou, Timothy Constandinou
Collaborators: Themis Prodromakis (University of Southampton), Dirk Koch and Piotr Dudek (University of Manchester)
Funding: EPSRC Programme Grant
Website: www.memristors.eu

I2MOVE – Intelligent implantable modulator of Vagus nerve function for treatment of obesity

The I2MOVE project is about tackling obesity. Classified by the World Health Organization (WHO) as one of the major health challenges of the 21st century, it is now a global pandemic. Obesity is one of the leading causes of death, ahead of malnutrition and infectious diseases. Today, more than 1.9 billion adults and 42 million children are overweight or obese worldwide - numbers which are only predicted to rise in the future.

Currently the most effective treatment for obesity is bariatric surgery, a procedure that can cause a dramatic reduction of excess weight. This surgery is however only recommended for extreme cases as it entails serious risks. The number of bariatric operations performed by the NHS has increased dramatically to around 8,000 per year. However, in the UK, where two-thirds of adults and one in ten children are obese or overweight, it is not economically feasible to perform bariatric surgery in all cases.

In this project, we are designing a bio-inspired implant that will serve as a novel treatment for obesity. The aim is to target the vagus nerve which transmits information between the gut and the brain. By stimulating the vagus nerve with electrical impulses, the implant will mimic the natural satiety signals produced after a meal, providing the patient with a means of appetite control.



Our team: Nishanth Kulasukeram, Khalid Mirza, Krzysztof Wildner, Konstantin Nikolic, Chris Toumazou
Collaborators: Partnership between CBIT and Department of Medicine
Funding: European Research Council (ERC) Synergy
Website: www.imperial.ac.uk/a-z-research/i2move/

SenseBack – Enabling Technologies for Sensory Feedback in Next-Gen Assistive Devices

The goal of this project is to develop technologies that will enable the next generation of assistive devices to provide truly natural control through enhanced sensory feedback. Our long-term vision is for artificial arms that provide the user with a sense of feedback that recreates the natural feedback associated with a real arm. To enable this level of feedback, we must meet two clear objectives: to generate artificial signals that mimic those of the natural arm and hand, and to provide a means of delivering those signals to the nervous system of a prosthesis user.

These objectives will be achieved by: building new fingertip sensors to give the prosthesis a realistic sense of touch, including pressure, shear and temperature; developing a ‘virtual hand’ that mimics the nerve impulses that would be produced by a real hand, giving the user a sense of position of an artificial hand; and designing electrodes and a stimulation system that can deliver the simulated nerve impulses directly to the individual’s nervous system.

Integrating this level of naturalistic feedback into prosthetic devices will enable much higher levels of function to be achieved than is currently possible. This will advance the field of prosthetics, provide enhanced function to prosthesis users and decrease the learning time involved when acquiring a new device.

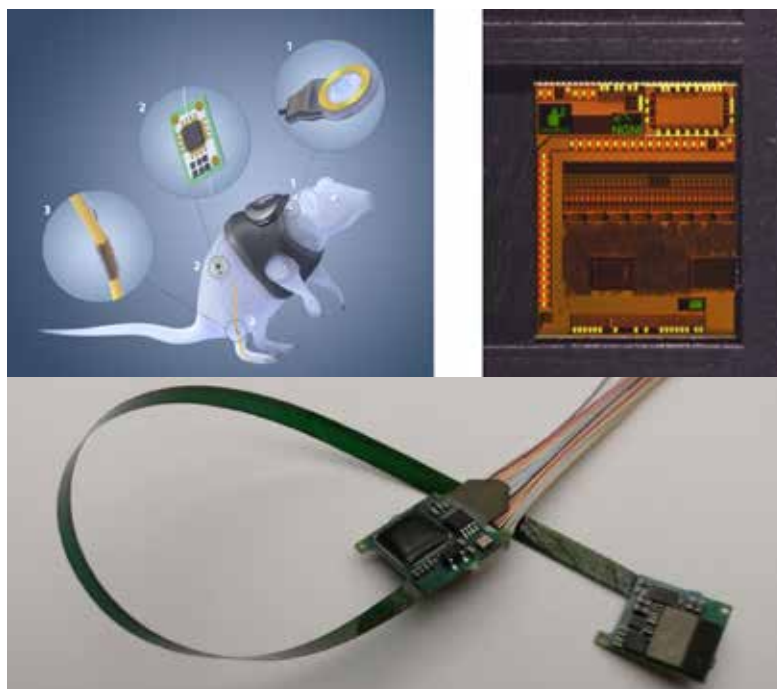

Our team: Adrien Rapeaux, Ian Williams, Timothy Constandinou
Collaborators: Universities of Newcastle, Southampton, Essex, Keele, Leeds
Funding: EPSRC
Website: www.imperial.ac.uk/neural-interfaces/research/projects/senseback/
www.senseback.com

New Methods for Biosensing and Neuroscience Research Tools

Standalone Headstage for Neural Recording with

Real-Time Spike Sorting and Data Logging: This project developed a platform technology that converts the raw signal from electrodes into a stream of identified spike events suitable for subsequent processing by conventional digital microelectronics. This platform is suitable for incorporation into a range of wireless, implantable devices.

Optical Neural Recording for Large-Scale Activity

Monitoring: This project is developing a method to detect neural activity optically without the use of any external marker, by measuring the changes in the refractive index of neurons during activity.

Challenges and opportunities of using coherent ultra-wideband radar-on-chip for medical sensing and imaging:

The recent innovation of a UWB radar-on-chip, at the size of a finger nail, provides the opportunity of in-body radar imaging with extremely small and low-cost electronics. The goal of this research is to investigate the challenges and opportunities of using coherent UWB radar-on-chip for medical sensing and imaging.

Microdevices to Investigate Sleep and Temperature

Regulation in Mice: Sleep is essential for all animals, yet its specific function is unknown. Moreover, the overlap between the neuronal circuitry underlying sleep, the actions of sedative drugs, and temperature regulation is a mystery. This project aims to develop novel research tools to allow the continuous recording of these parameters over many days, and facilitate thermal regulation of the brain, so that the impact of temperature can be investigated in both sleep and sedation.



Our team: Bryan Hsieh, Timo Lauteslager, Song Luan, Francesca Troiani, Ian Williams, Konstantin Nikolic, Tor Sverre Lande, Timothy Constandinou
Collaborators: Nick Franks, Bill Wisden (Life Sciences), Andrew Jackson (Newcastle University), Rodrigo Quian Quiroga (University of Leicester)
Funding: EPSRC



Next Generation Neural Interfaces (NGNI) research group members: 1. Francesca Troiani; 2. Song Luan; 3. Yan Liu; 4. Timo Lauteslager; 5. Michal Maslik; 6. Lieuwe Leene; 7. Adrien Rapeaux; 8. Izabela Wojcicka-Grzesiak (CBIT senior group administrator); 9. Ian Williams; 10. Peilong Feng; 11. Nur Ahmadi; 12. Bryan Hsieh; 13. Katarzyna Szostak; 14. Timothy Constandinou; 15. Dorian Haci; 16. Federico Mazza; 17. Matthew Cavuto; and 18. Oscar Savolainen.

For a complete list of all ongoing research projects please visit:
www.imperial.ac.uk/neural-interfaces/research/projects

See also the Imperial College London Centre for Neurotechnology:
www.imperial.ac.uk/neurotechnology
Follow us on Twitter @ImperialNeuro

Funded and supported by:



Dr. Winston Wong



Chip gallery

Centre's researchers have produced six new chips this year making a total production so far of 68 unique chip designs in a variety of CMOS technologies. The Centre's focus is primarily the application of modern semiconductor technology to develop new bio-inspired, biomedical, and medical devices. This has in part been made possible through the EU-subsidised multi-project wafer (MPW) brokerage service provided by Europractice, which provides our design tools via STFC (UK) and technology access via IMEC (Belgium) and Fraunhofer (Germany).

See also:

GENERAL CHIP GALLERY

www.imperial.ac.uk/bio-inspiredtechnology/resources/chip-gallery

NEURAL RELATED CHIP GALLERY

www.imperial.ac.uk/neural-interfaces/resources/silicon-chip-gallery

CBIT18B01 (YLN2018)

Technology: AMS 0.35 μ m 2P4M CMOS (C35B4C3)

Silicon area: 2.4mm \times 3mm

Purpose: ENGINI neural acquisition System-on-Chip, Bio-Signal Data Converter, Neuro-Modulation Front-End

Designers: Lieuwe Leene, Michal Maslik, Peilong Feng, Yan Lui, Nishanth Kulasekaram, Konstantin Nikolic, Timothy Constandinou

Tape-out: February 2018

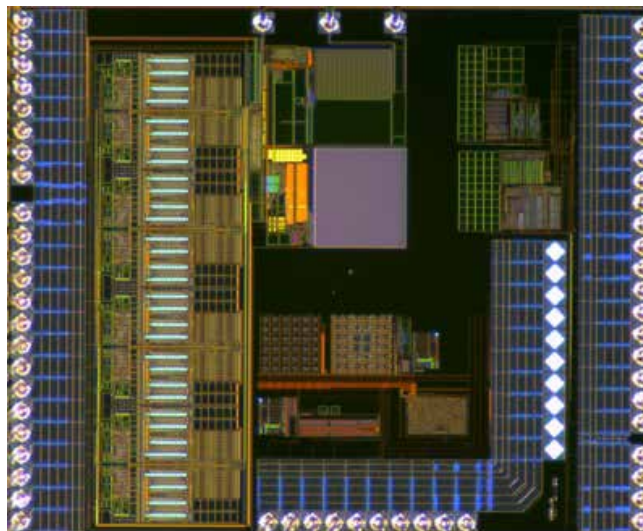

CBIT18B02 (LEGOLAS)

Technology: AMS 0.35 μ m 2P4M CMOS (C35B4C3)

Silicon area: 3.7mm \times 3mm

Description: Integrated chemical imagers for real-time ion imaging and DNA detection including test devices for impedance spectroscopy.

Designers: Junming Zeng, Miguel Cacho Soblechero, Nicolas Moser, Nicholas Miscourides, Pantelis Georgiou, Matthew Douthwaite.

Tape-out: February 2018

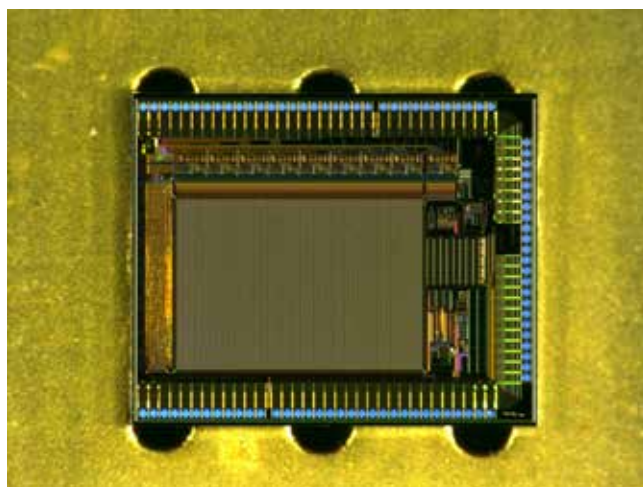

CBIT18E01 (opto)

Technology: AMS 0.35um C35B4

Silicon area: 2.1x2.6

Purpose: Optical communication, prototype sensor and devices

Designers: Andrea Demarcellis, Yan Liu, Timothy Constandinou, Guido Di Patrizio Stanchieri, Marco Faccio, Elia Palange

Tape-out: May 2018

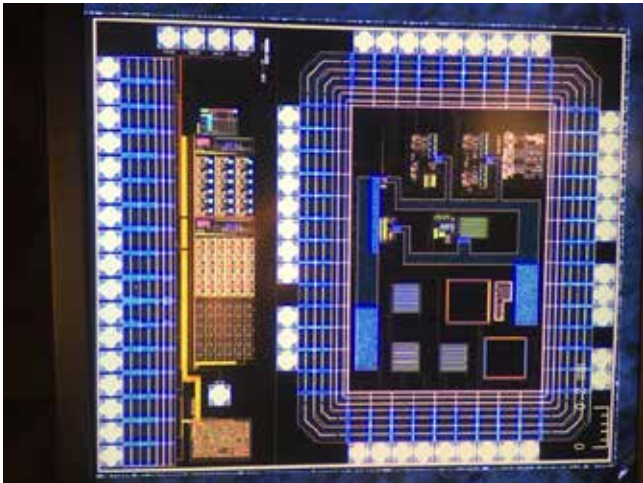

CBIT18I02 (Black Pearl)

Technology: TSMC 0.18um BCD HV

Silicon area: 4mm x 2mm

Description: Next-gen DNA imagers with ultra-high frame rate and real-time programmability.

Designers: Junming Zeng, Miguel Cacho Soblechero, Pantelis Georgiou.

Tape-out: September 2018

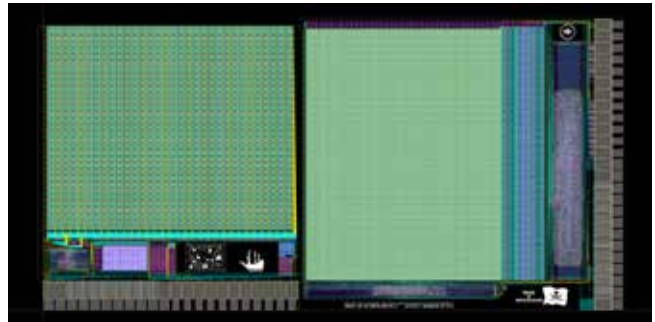

CBIT18I01 (Skywalker)

Technology: TSMC 180nm

Silicon area: 5 mm x 5 mm

Purpose: ISFET sensing array with 28k pixels for ion imaging and disease detection.

Designers: Nicolas Moser, Tor Sverre Lande, Pantelis Georgiou

Tape-out: September 2018

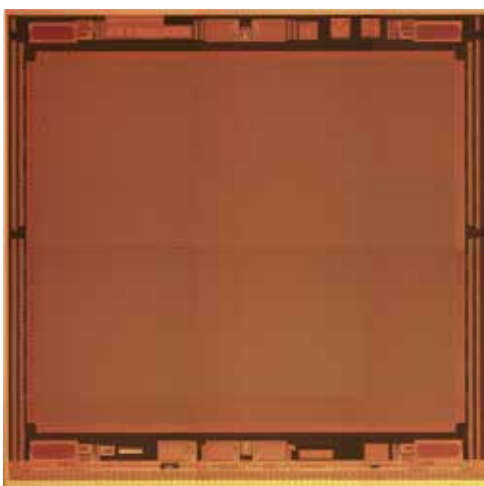

CBIT18J01 (Bearfoot)

Technology: TSMC 180nm, High Voltage BCD

Silicon area: 2.15mm x 4 mm

Purpose: i2MOVE (Intelligent Implantable Modulator of Vagus Nerve Function for Treatment of Obesity) final chip: System on Chip incorporating two chemical and one electrical recording channels with corresponding ADCs, digital signal processing engine for deciding when to stimulate and the stimulation dosage, and electrical stimulation block.

Designers: Nishanth Kulasekaram, Mirza Khalid, Yan Liu, Konstantin Nikolic (supervision)

Tape-out: October 2018

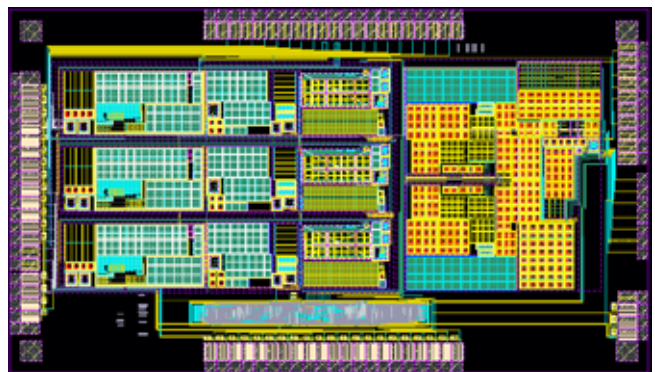

The laboratory areas have been designed to meet the needs of the four main application areas within the Centre’s research strategy. Researchers have been able to undertake a large number of high-quality research projects in the Centre by leveraging on the multidisciplinary expertise of their colleagues and collaborators and the employment of the facilities.

Research facilities

The main thrust of the research strategy is not to further advance the performance of existing electronic systems but to enable entirely new applications by utilizing well-established technologies in new, innovative ways. All members of the Centre have access to the full range of facilities and equipment and some researchers have developed a high level of expertise in specific areas to ensure that these are exploited to the full.



XCBIT CAD LABORATORY

The Centre for Bio-Inspired Technology hosts a CAD Laboratory equipped with high-end workstations and industry-strength EDA tools for the design, simulation & verification of integrated circuits & microsystems.

CAD is an indispensable process in any modern engineering design. This laboratory is equipped with high performance workstations and servers to support high-end tools for microelectronic design, microsystems (including MEMS, microfluidics), RF/microwave devices, mechanical design, etc. For example, researchers here develop application-specific integrated circuits (ASICs) that are then sent for fabrication at CMOS foundries. The facility has licensed all industry standard tools including Cadence, Mentor Graphics, Synopsys, Ansys, Solidworks, and several others, and a range of modern process technologies down to the 45nm node. All servers can be remotely connected from anywhere around the world via the internet enabling designers to work remotely and multiple chip designs can be carried out in parallel.



ELECTROMAGNETICS TEST LABORATORY

Within this facility is a large, shielded, certified anechoic chamber, valid up to 34GHz, a 67GHz Agilent PNA with Cascade manual probe station and E-CAL automatic calibration for discrete SMA socketed use (up to 26.5GHz), an 8GHz 40Gs/s Agilent oscilloscope and a Picosecond pulse generator, as well as a host of other miscellaneous instruments. It is unique for the Centre to have access to such a chamber and it provides an ideal test facility for any project involving on-body or in-body antennas and indeed the communication between both. This, in conjunction with equipment such as the Agilent PNA and Dielectric Probe facilitates the use of anatomically and electromagnetically correct bio-phantoms to replicate the losses incurred when sensors and antennas are implanted in the body, leading to quicker prototype development and proof of concept.

ANECHOIC (RF AND ACOUSTIC) TEST CHAMBERS

State-of-the-art soundproof and electromagnetic radiation proof chambers for ultra-low noise sensing. The acoustic facility includes a large (5m x 5m x 2m) anechoic shielded chamber providing an extremely low-noise environment suitable for all low frequency acoustic, optical and mechanical device/sensor characterisation. The RF facility includes a large (4m x 3m x 2m) anechoic shielded chamber suitable for a wide range of low noise measurements with significantly attenuated electromagnetic levels. This has been calibrated for uninterrupted use between 10MHz and 34GHz.

CLEANROOM SUITE

The Centre has a suite of two ISO class 6 cleanrooms (equivalent to US standards class 100). These have been designed to support CE Marking/FDA approvals, to class 100/1000 to develop biosensor devices, electrode and microfluidic fabrication, packaging/post-processing of CMOS chips and support research in any other areas requiring particle-free environment.

The largest room, the 'yellow' room, houses most of the fabrication tools/processes and all relevant inspection and measurement facilities. This includes photolithography tools – mask aligner with Nano Imprint Lithography (NIL) attachment, direct laser

writing system, 3D laser nanolithography, two PVD systems for thin film deposition of metals, oxides and organics, surface characterisation tools, oxygen plasma chamber as well as wet and dry benches. Smaller 'white' room houses various equipment allowing for wet silicon oxidation, wire bonding, Parylene deposition and electrochemical processes.

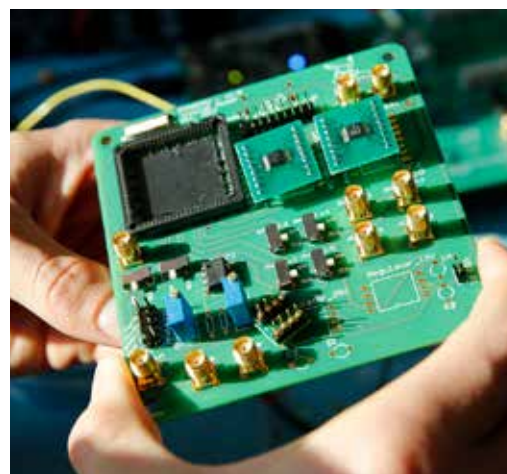

MICROELECTRONICS LABORATORY

This laboratory is comprehensively equipped for the development, testing and measurement of biomedical circuits and systems. Such devices often require low noise instrumentation operating at relatively low frequency and have ultra low power requirements. This facility includes instruments for semiconductor characterisation, equipment for time, frequency and impedance characterisation (e.g. oscilloscopes, spectrum analysers, CV), instruments for low noise transimpedance and voltage amplification, signal generation, a semi-automatic probe station with laser for trimming and failure analysis, a temperature chamber, PCB rapid prototyping facility (LPKF-based), and all standard electronic test & measurement equipment.

BIOTECHNOLOGY LABORATORY

The Biotechnology Lab is the first of its kind in the Department of Electrical and Electronic Engineering and it contains all necessary equipment for molecular biology and cell culture work, with focus on infectious diseases and cancer. The facility includes separate pre- and post-PCR areas to minimise DNA contamination, with instruments for extraction, analysis, manipulation and storage of genetic material. The laboratory is equipped with a Class II biological safety cabinet for pathogen containment, contamination control and sterility, a PCR-workstation with laminar flow and UV to prevent unwanted contamination and a laminar fume hood for working with hazardous chemicals is also installed. A CO₂ incubator and an inverted fluorescence microscope for cell culture work are also in place. In addition to these; authorised users have access to two conventional thermal cyclers, two quantitative real-time PCR instruments, -80C and -20C freezers, a horizontal gel electrophoresis system, and all standard lab equipment such as micropipettes, microfuges, pH meters, vortex mixers, balances, dry bath incubators and bench-top centrifuges.

CBIT goes social



NGNI snacking while working



Tim's 40th

Tim's 40th



King Tim of NGNI, first of his name



Kasia and Fran are up to something



NGNI, postits, a fireplace and lots of laughter



NGNI waits for dinner...



... And what a dinner!



NGNI enjoys breakfast...



Tim's drone, NGNI and the away house

Celebrating Dr N Moser!



Half NGNI recharges after exhausting sport activities



NGNI blindfolded team work



NGNI blindfolded team work



BIOCAS delegation at Niagara Falls



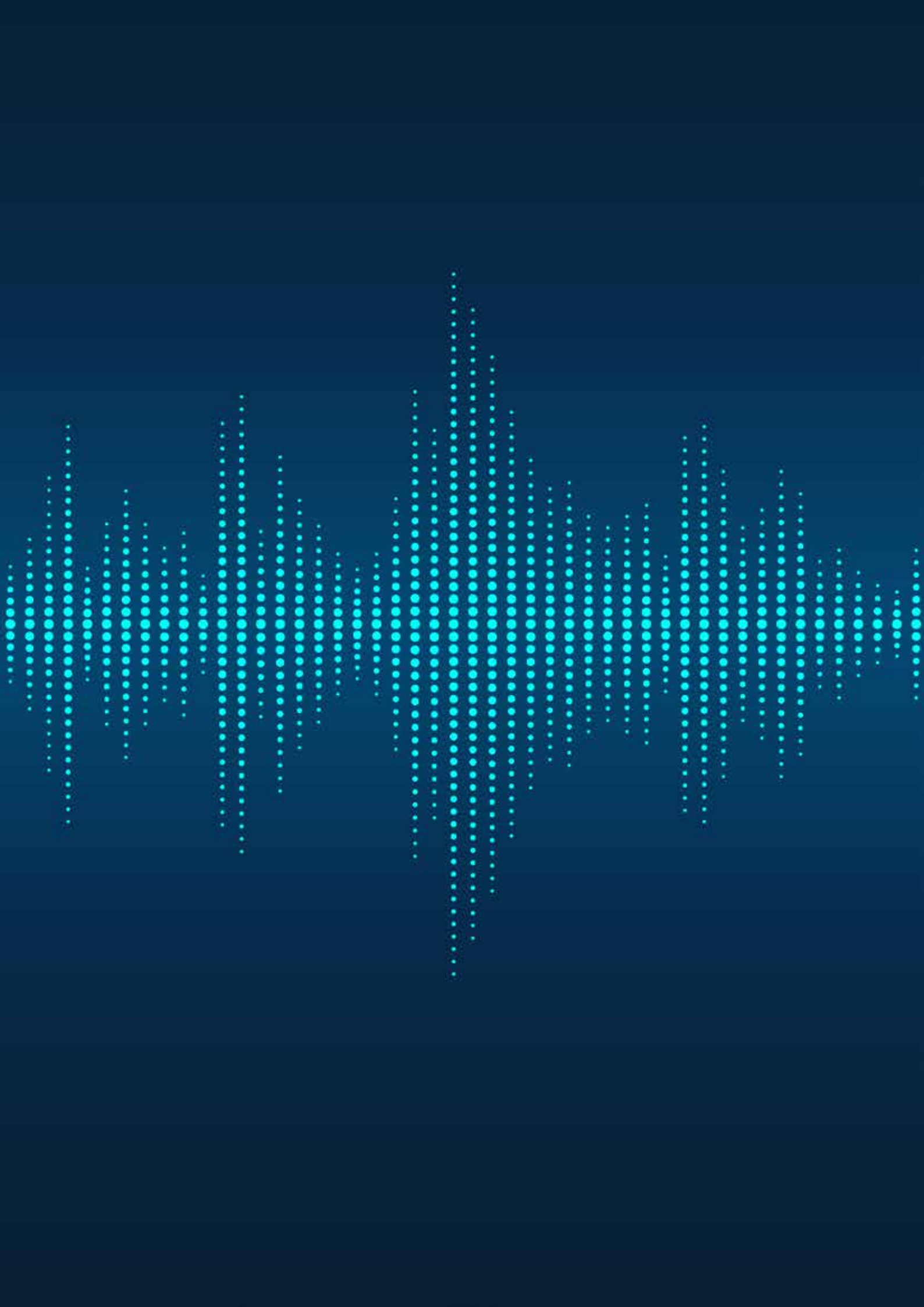



Who we are

Academic staff profiles — 36

Administrative staff profiles — 41

Staff research reports — 42

Research student & assistant reports — 57

ACADEMIC STAFF

www.imperial.ac.uk/people/c.toumazou

 @ProfDNA

Professor Chris Toumazou

Regius Professor of Engineering



Regius Professor Chris Toumazou is the Director of the Centre for Bio-Inspired Technology and the Chief Scientist and Founding Director of the Institute for Biomedical Engineering at Imperial College London. He is also the Founder of numerous biotechnology companies including Toumaz Ltd, DNAe Ltd, and Co-Founder of DnaNudge Ltd. He holds over 70 international patents and has published over 400 research papers. He has been recognised by many prestigious awards including the 2014 European Inventor Awards, the Royal Society Gabor Medal and the Faraday Medal.

DnaNudge technology provides simple dietary guidance in the form of product swaps, based on the user's DNA. The wearable technology allows people to carry DnaNudge on their wrist to receive dietary guidance when they need it.

ACADEMIC STAFF

www.imperial.ac.uk/people/t.constandinou

 @tgconstandinou

Timothy Constandinou, PhD

Reader in Neural Microsystems, EPSRC Fellow



Timothy Constandinou originally trained in Electronic Engineering at Imperial College London. He is currently Deputy Director of the Centre for Bio-Inspired Technology and leads the Next Generation Neural Interfaces (NGNI) lab. His group utilises integrated circuit and microsystem technologies to create new research tools for neuroscience and neuroprosthetic devices. He has projects on brain machine interfaces, epilepsy, sleep, as well as tackling fundamental challenges in electronic and implantable technology. Within IEEE he serves on the CAS Society Board of Governors, BRAIN Initiative Steering Committee and BioCAS/Sensory Systems Technical Committees. He co-chairs the Royal Society emerging technologies group in Neural Interface Ecosystems.

ENGIN is developing a new type of mm-scale implantable neural microsystems that directly tackle the grand challenges of long term stability, energy efficiency, and scalability.

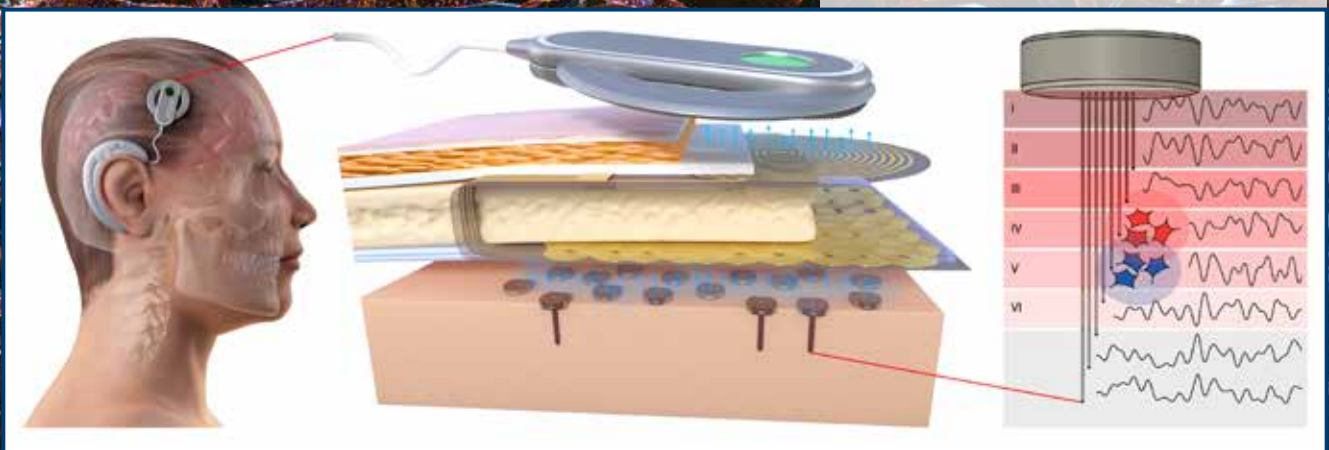

Pantelis Georgiou, PhD

Reader in Biomedical Electronics

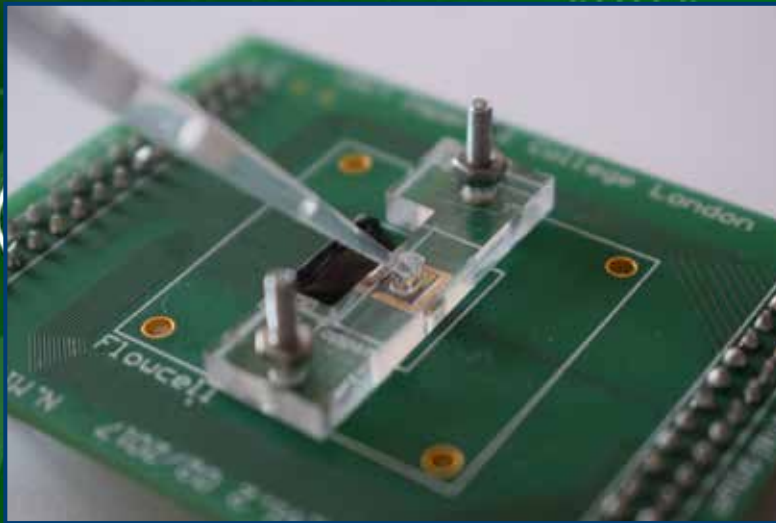

Pantelis Georgiou is a Reader within the Department of Electrical and Electronic Engineering and is also the Director of the Bio-inspired Metabolic Technology Laboratory within the Centre for Bio-Inspired Technology. His research focuses on ultra-low power micro-electronics, bio-inspired circuits and systems, lab-on-chip technology and application of micro-electronic technology to create novel medical devices. Application areas of his lab include technologies for treatment of diabetes such as the artificial pancreas, novel Lab-on-Chip technology for rapid diagnostics of infectious diseases, and wearable technologies for rehabilitation of chronic conditions. Within IEEE he serves on the IEEE Sensors Council, BioCAS/Sensory Systems Technical Committees, and is a Distinguished Lecturer in Circuits and Systems.

A snapshot of the application of my research. Shown is a rapid diagnostic for detection of infectious diseases using CMOS ISFET arrays (top), the Bio-inspired Artificial Pancreas for treatment of diabetes (bottom left) and a wearable real-time muscle fatigue monitor to aid rehabilitation (bottom right).



ACADEMIC STAFF

www.imperial.ac.uk/people/c.mcleod

Professor Chris McLeod

Principal Research Fellow

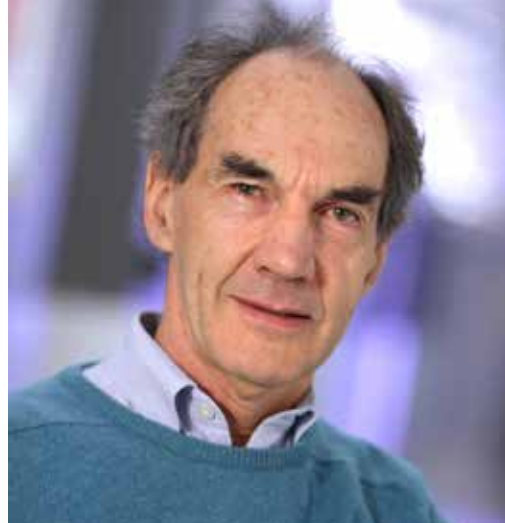

Chris McLeod has been leading a research group within CBIT since its inception, developing implantable wireless transponders to sense pressures within the body. The first application is to measure Pulmonary Arterial Pressure (PAP) continuously in patients suffering from Heart Failure. The clinical case is strong, as PAP is the principal variable clinicians wish to control using pharmaceutical therapy but is not accessible for non-invasive measurement. The SAW sensors can be powered remotely by RF and read remotely. The power requirements are suitable for long-term battery powering, enabling patients to be fully ambulatory. The wealth of information from reliable, continuous, multi-parameter data will enable better artificial intelligence to be applied in automated analysis to extract and present only important clinical features

Body-worn reader alongside a smartphone for comparison and detail of a SAW structure.

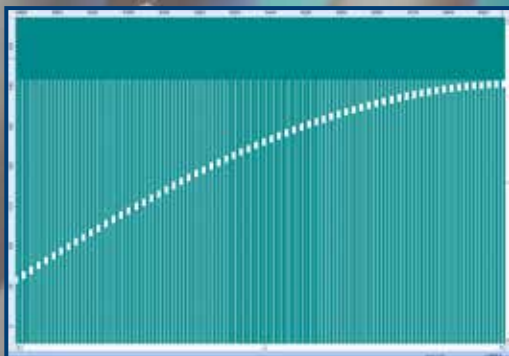
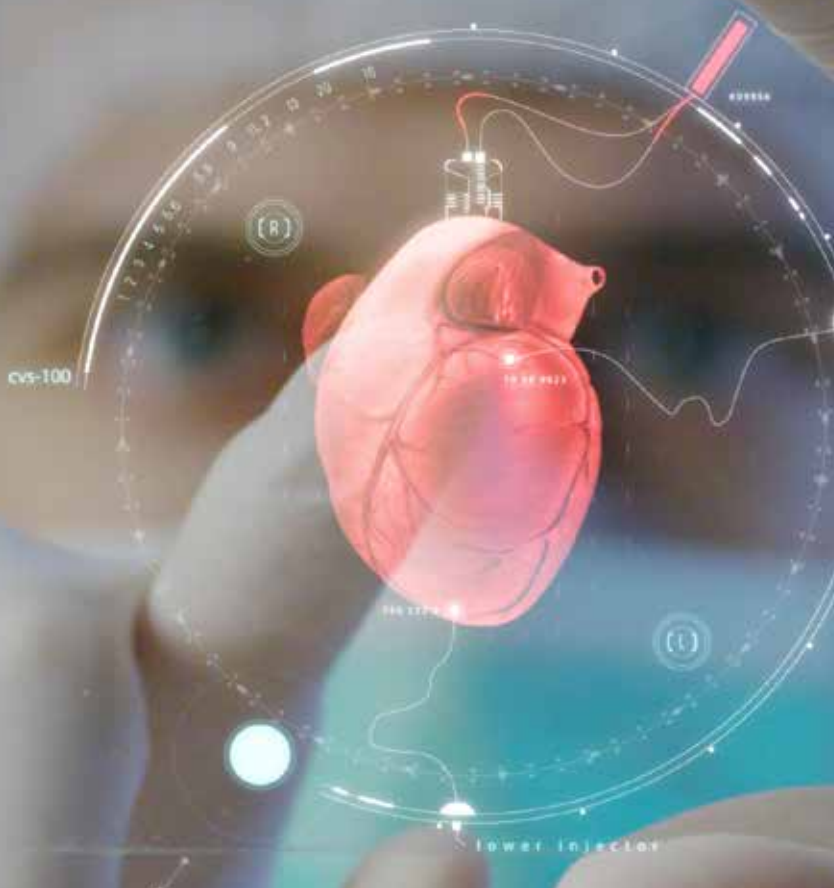

Konstantin Nikolic, PhD

Senior Research Fellow (Associate Professor – Research)



Konstantin received a DiplEng and Masters from the Department of Electrical Engineering, Belgrade University, Serbia and a PhD in Condensed Matter Physics from Imperial College London. He was a Lecturer and Associate Professor at the Faculty of Electrical Engineering, Belgrade University (teaching Physics, Quantum Mechanics and Semiconductor Devices) in the period 1994–1999. Then he moved to UCL (Department of Physics and Astronomy, Image Processing Group) until he joined the Institute of Biomedical Engineering, Imperial College London in 2005. In 2006 he became Corrigan Research Fellow and in 2012 Senior Research Fellow. Konstantin leads the Bio-modeling group at the CBIT, which develops methods and computational tools for understanding, modelling and simulating various biological and physiological processes and their applications in bio-inspired electronic systems. He also leads the research programme of i2MOVE project, which is developing a closed loop system for neural recording and stimulation.

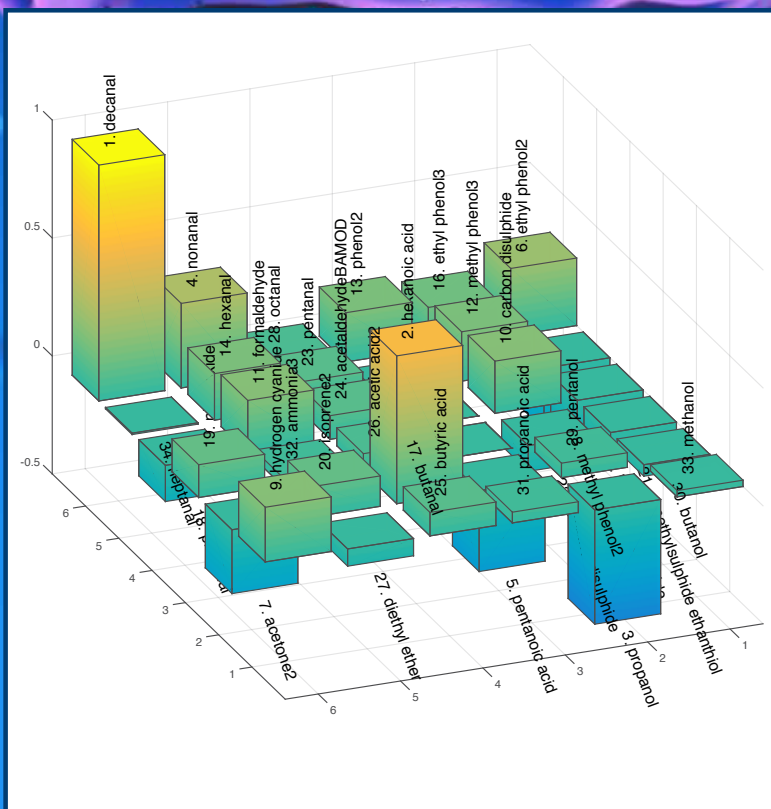

Assessment of non-invasive exhaled breath test for the diagnosis of oesophagogastric cancer. Volatile Organic Compound (VOC) breath model of OE cancer: Graphical illustration of changes in all VOCs between study groups (163 had cancer and 172 were in control group). Positive deflection indicated an upregulation in the cancer group and a negative deflection indicated a downregulation in the cancer group relative to the non-cancer group.



Wiesia Hsissen

Senior Group Administrator, Circuits and Systems Research Group,
Department of Electrical and Electronic Engineering
www.imperial.ac.uk/people/w.hsissen

Wiesia is the senior group administrator of the Circuit and Systems (CAS) research group and additionally has the role of PA to the Head of Department. She joined the Department of Electrical and Electronic Engineering in 1990 and has kept a key role in supporting the CAS group ever since.

Her role within the Centre for Bio-Inspired Technology is to support our postgraduate research students from PhD registration and bursaries to thesis submission and examination.



Gifty Osei-Ansah

PA to Professor Chris Toumazou
www.imperial.ac.uk/people/g.osei-ansah

Gifty joined the Centre in 2010 as PA to Professor Toumazou. She provides the essential support he needs to fulfil his various roles including as Director of the Centre, Professor of Biomedical Circuits in the Department of Electrical and Electronic Engineering and CEO to Toumaz Ltd and DNA Electronics Ltd.



Izabela Wojcicka-Grzesiak

Senior Group Administrator, Centre for Bio-Inspired Technology
www.imperial.ac.uk/people/i.wojcicka

Iza is the group administrator for the Centre for Bio-Inspired Technology. She originally joined Imperial in 2006 as an administrator within the Institute of Biomedical Engineering and was appointed group administrator of the Centre in 2009 when it was formed.

Iza now plays a key role within the Centre supporting staff, students, research and facilities. Within her role she deals with all matters relating to finance, HR, health and safety and general administration.

FELLOW

www.imperial.ac.uk/people/m.bahmanyar

Mohammad Reza Bahmanyar, PhD



Dr Bahmanyar received his PhD from Brunel University in 2006. He has been doing research at the interface of engineering/physics with medicine for eighteen years. His research aims to address unmet needs in medical devices that may improve the quality of life of patients across the world. He joined the Institute of Biomedical Engineering in 2009. Currently, he directs research on cardiovascular devices as well as intraocular implantable sensors. His research on implantable pressure sensors has attracted significant commercial interest.

Implantable sensors based on acoustic wave devices.

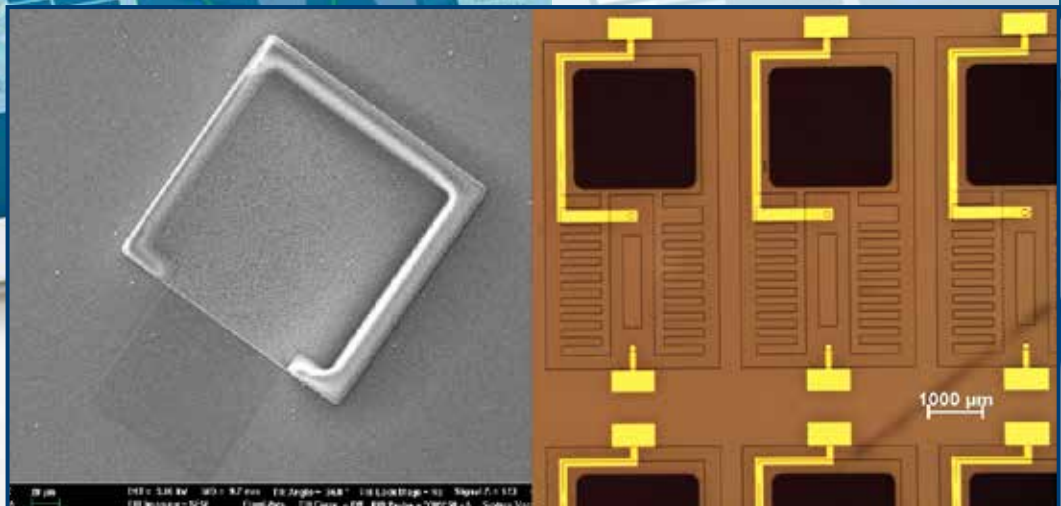

FELLOW

www.imperial.ac.uk/people/p.herrero-vinias

Pau Herrero-Viñas, PhD

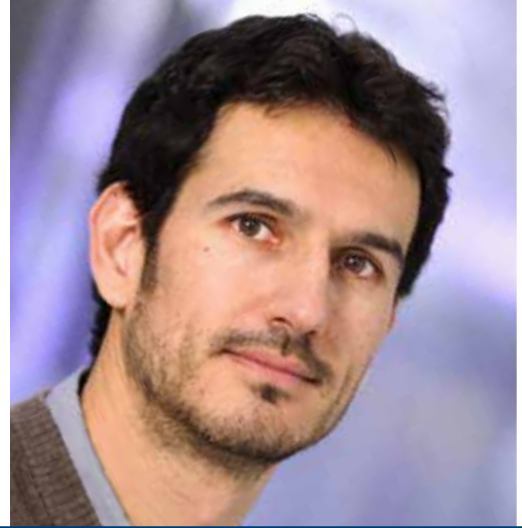

Pau Herrero-Viñas holds a PhD degree on Automation Technologies by University of Angers (France) and University of Girona (Spain). After his PhD, Pau did a postdoctoral stay at the University of California Santa Barbara (USA) working on diabetes technology projects. He then spent two years at the Autonomous University of Barcelona/Hospital de Sant Pau (Spain) leading different eHealth projects related to the prevention of metabolic diseases. His main research interest lies in developing biomedical control systems and intelligent clinical decision support systems for diabetes and infection diseases management.

Biomedical control and intelligent clinical decision support systems for diabetes and infection diseases management.

pepper Horizon 2020
patient empowerment through predictive personalised decision support

MDI Architecture **CSII Architecture**

b-iap Bio Inspired Artificial Pancreas **wellcome trust**

Control unit Insulin pump Glucose sensor User interface

epicmpoc National Institute for Health Research
enhanced, personalised and integrated care for infection management at point of care

4c dynamic bolus calculator for diabetes management **DEXCOM**

Case-based Reasoning Mobile App Glucose sensor Insulin pen

FELLOW

www.imperial.ac.uk/people/m.kalofonou

Melpomeni Kalofonou, PhD



Analysis of circulating tumor DNA (ctDNA)

Dr Melpomeni Kalofonou is a Research Fellow and Cancer Technology Lead at the Centre for Bio-Inspired Technology. She has conducted pioneering work in the application of microchip technology for detection of cancer biomarkers, through design and fabrication of microchip devices, integrating chemical sensors with molecular biology assays, leading to the development of Lab-on-Chip systems for detection and computation of genetic and epigenetic targets for cancer. One of her key research areas is on liquid-biopsy cancer diagnostics, enabling detection of breast cancer specific mutations in the tumour derived fraction of circulating-free DNA in blood, towards the development of a sample-to-result system for patient stratification and monitoring of tumour progression.

Detection of circulating tumour DNA (ctDNA) breast cancer mutations using sample-to-result microchip technology – Cancer relapse/Resistance

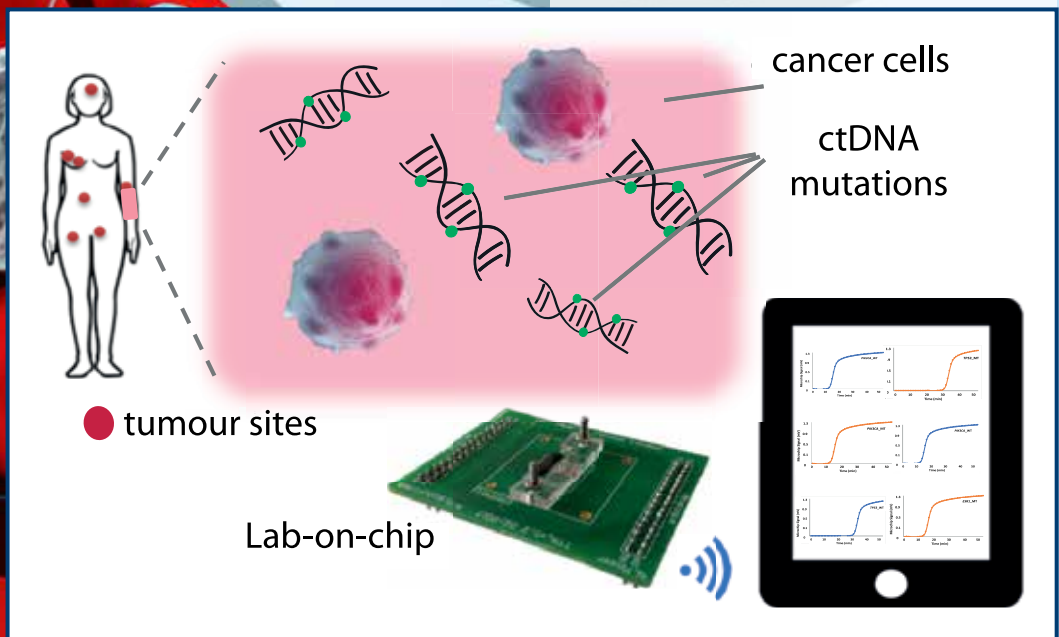
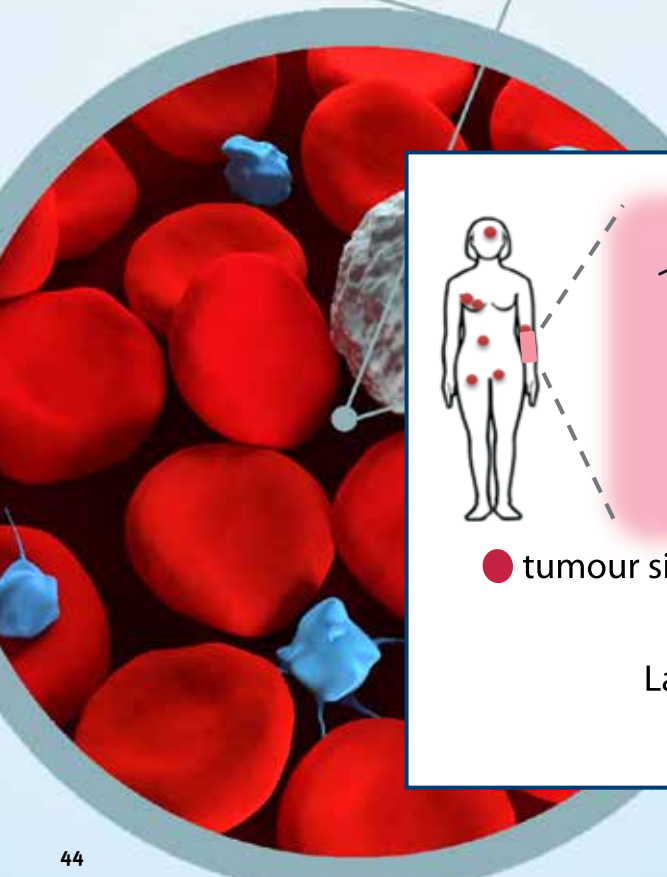

FELLOW

www.imperial.ac.uk/people/yan.liu06

Yan Liu, PhD



Yan Liu received the B.Eng degree in 2006 Zhejiang University, China, the MSc degree in 2007 and PhD in 2012 from Electrical and Electronic Engineering at Imperial College London, UK. He is now a research fellow in Centre of Bio-inspired technology, Electrical and Electronic Engineering at Imperial College London. His research area includes: CMOS based lab-on-chip devices and platforms, brain machine interface, and novel mixed signal circuits for biomedical applications.

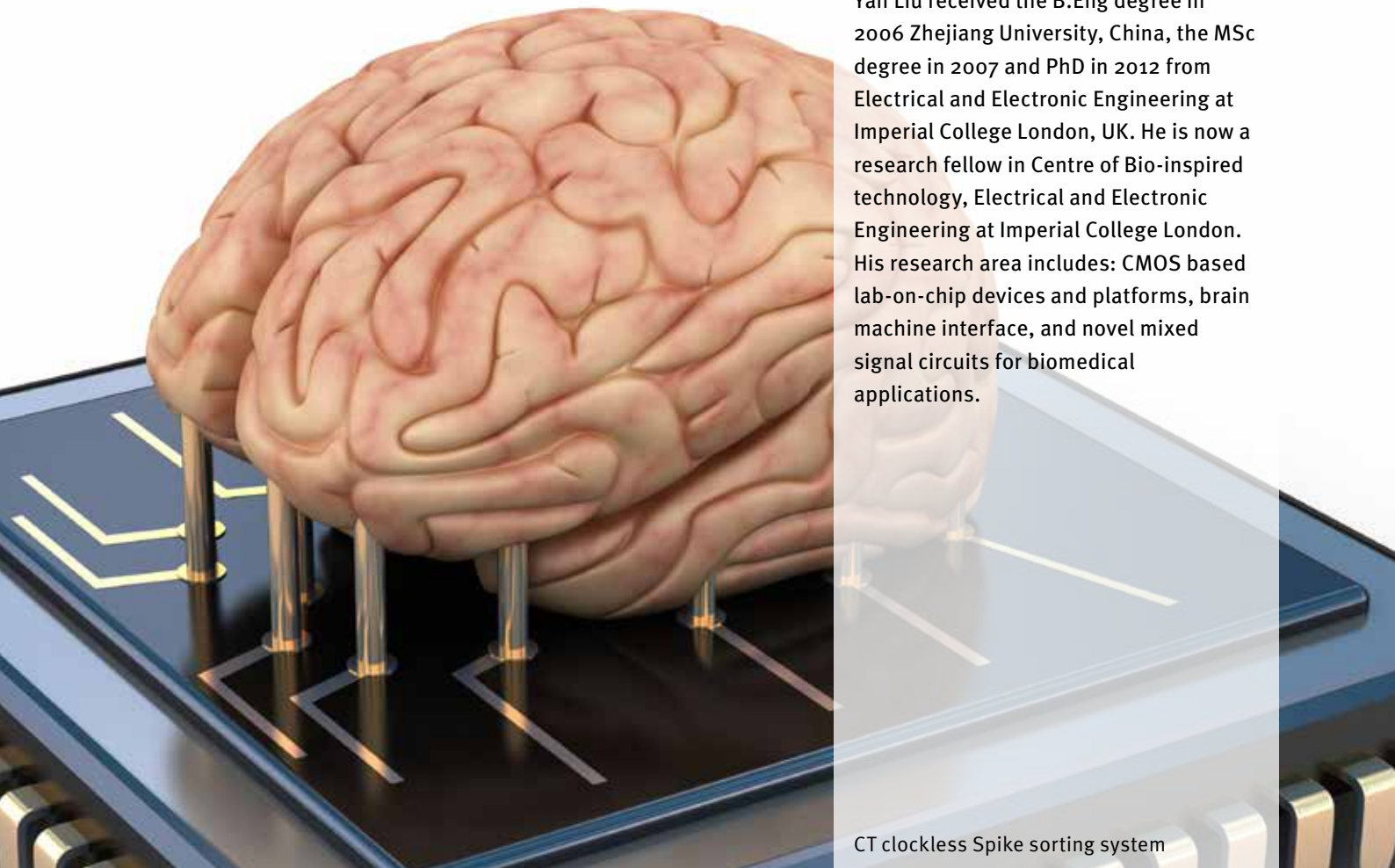

CT clockless Spike sorting system

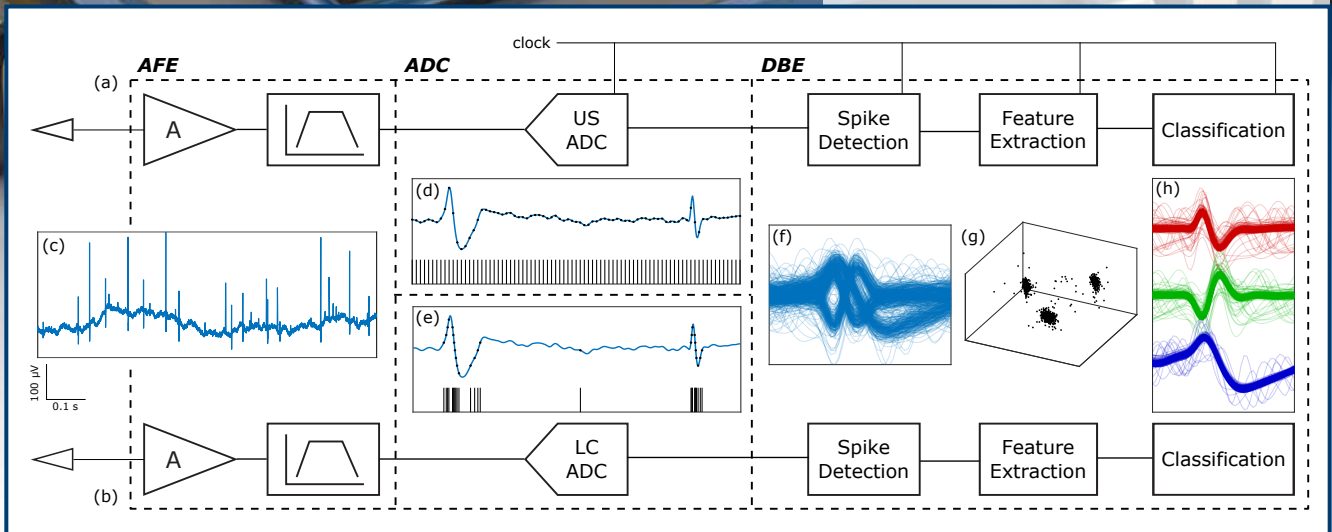

FELLOW

www.imperial.ac.uk/people/j.rodriguez-manzano

Jesus Rodriguez Manzano, PhD



He combines molecular and synthetic biology and engineering principles to generate revolutionary methods with the ability to not only provide rapid and cost-effective diagnostic solutions, but also to shed light on fundamental biological processes, their dynamics and their limitations. He has been always working at the interface between molecular microbiology and engineering developing cutting edge lab-on-chip diagnostic technologies for infectious diseases. Jesus has received comprehensive training in sample preparation methods, innovative molecular tools for detection/quantification/typing of pathogens, microfluidics, isothermal nucleic acid amplification chemistries, and digital single nucleic acid molecule analysis.

A novel point-of-care diagnostic platform for infectious diseases



- Microfluidic technologies
- Isothermal amplification chemistries
- CMOS technology

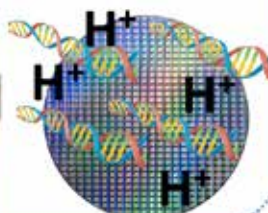
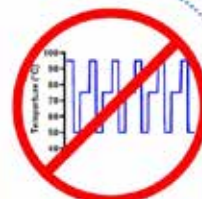

**ASSURED criteria
by WHO**

Sara S Ghoreishizadeh, PhD

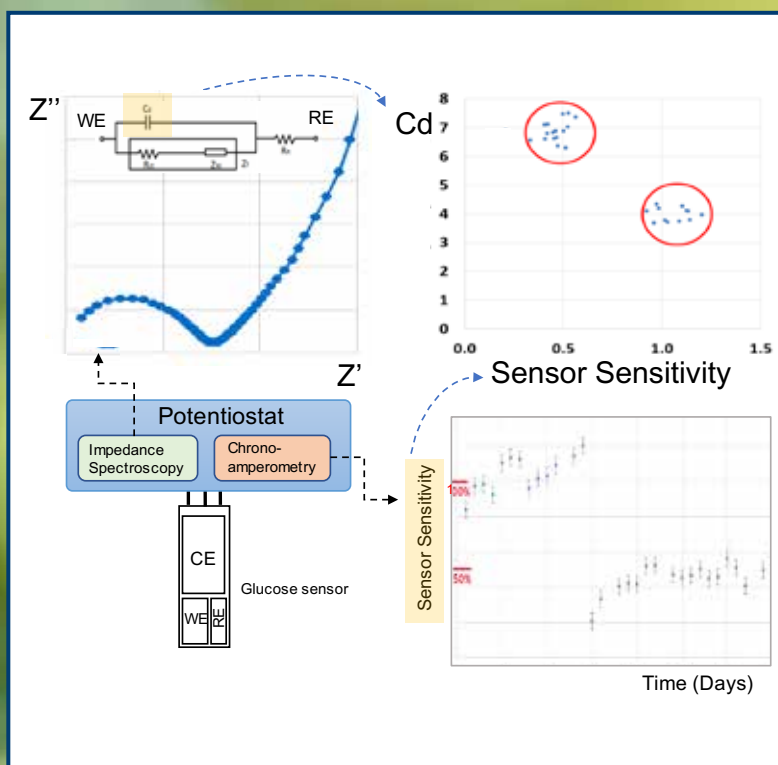

Dr Sara Ghoreishizadeh is currently a lecturer in wearable technology at University College London. She received a PhD from EPFL, Switzerland in 2015 and has been with CBIT as a Junior Research Fellow until Oct 2018. Her research interests include analogue/mixed-signal circuits design for wearable and implantable biosensors and the monolithic integration of biosensor with microelectronics, on which she has more than 30 peer-reviewed publications. She has been a technical/review committee member of IEEE BioCAS 2017–2018 and IEEE ICECS 2016–2018 conferences, an editor of the Journal of Microelectronics, an elected member of IEEE BioCAS technical committee, the co-organiser of UKCAS 2017, and a recipient of EPSRC eFutures ECR award 2017.

The sudden changes in the sensitivity of electrochemical glucose sensor is shown to be correlated with the impedance of the sensor. This correlation can be exploited, through dedicated circuits and algorithms, to implement in-situ auto-calibration of the sensor, paving the path for autonomous wearable biomolecule sensors.

ASSOCIATE

www.imperial.ac.uk/people/mohamed.el-sharkawy08

Mohamed El Sharkawy, PhD



I received the bachelor's degree in Electronics in 2007 from the German University in Cairo. Following that, I completed the MSc in Analog and Digital Electronics at Imperial College London in 2009. Shortly after, I began work as a research assistant in the Centre of Bio-inspired Technology, on the bio-inspired artificial pancreas project. This culminated in the completion of the PhD in 2016. Currently, we have begun a randomised control study using the bio-inspired artificial pancreas (BiAP) system. 20 diabetic participants will take part in three arms each lasting six weeks. The objective is to reduce hypoglycaemia and increase glucose time in target.

BiAP System Architecture

ASSOCIATE

www.imperial.ac.uk/people/caroline.golden11

Caroline Golden, PhD



Caroline completed her BEng in Biomedical Engineering at the National University of Ireland Galway (2011). She interned in Stanford University, where she worked on algorithms for detecting metal artifact reduction in CT images under the supervision of Professor Norbert Pelc. She completed her MSc in Bioengineering with Neurotechnology at Imperial College London (2012), and her PhD under the supervision of Dr Paul Chadderton (2016). She is currently working as a Research Associate at CBiT, where she is managing a clinical trial (ASPIRE-DNA) to examine the efficacy of a DNA-based dietary intervention to reduce the type 2 diabetes risk in pre-diabetic individuals.

The DNA-based dietary intervention that will be used in the ASPIRE-DNA clinical trial is based on the Nudgeomics method illustrated here

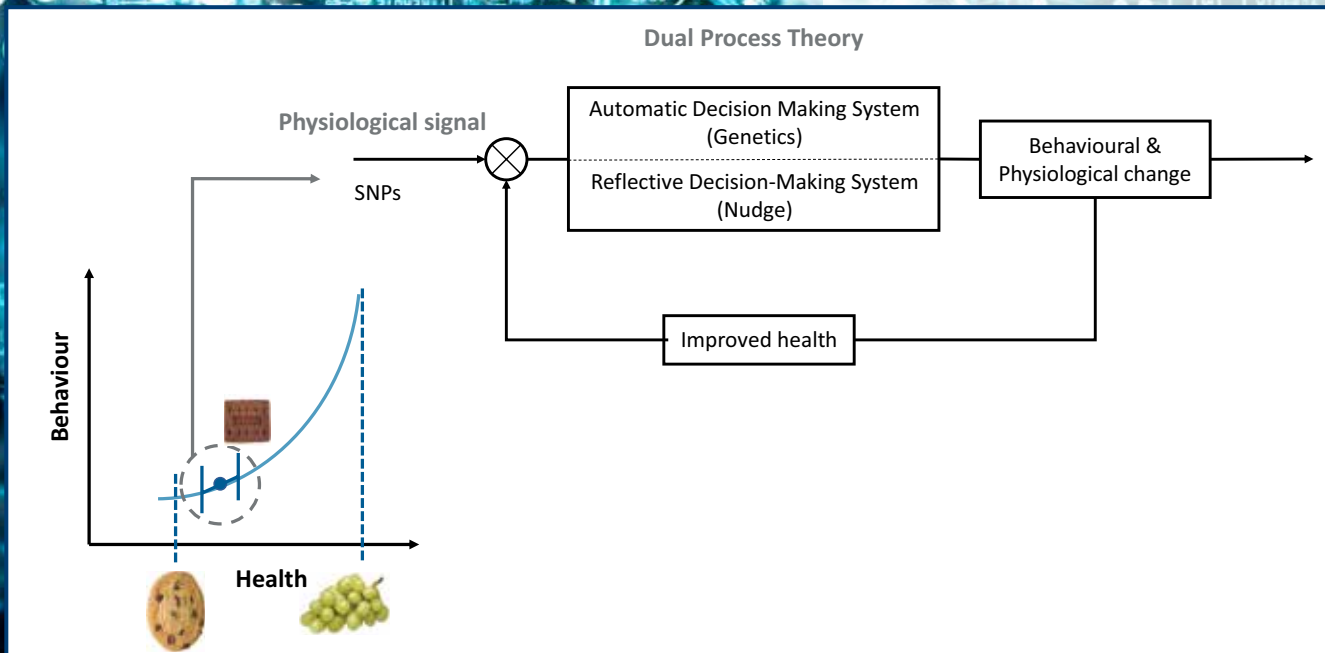

ASSOCIATE

www.imperial.ac.uk/people/lieuwe.leene11

Lieuwe B Leene, PhD

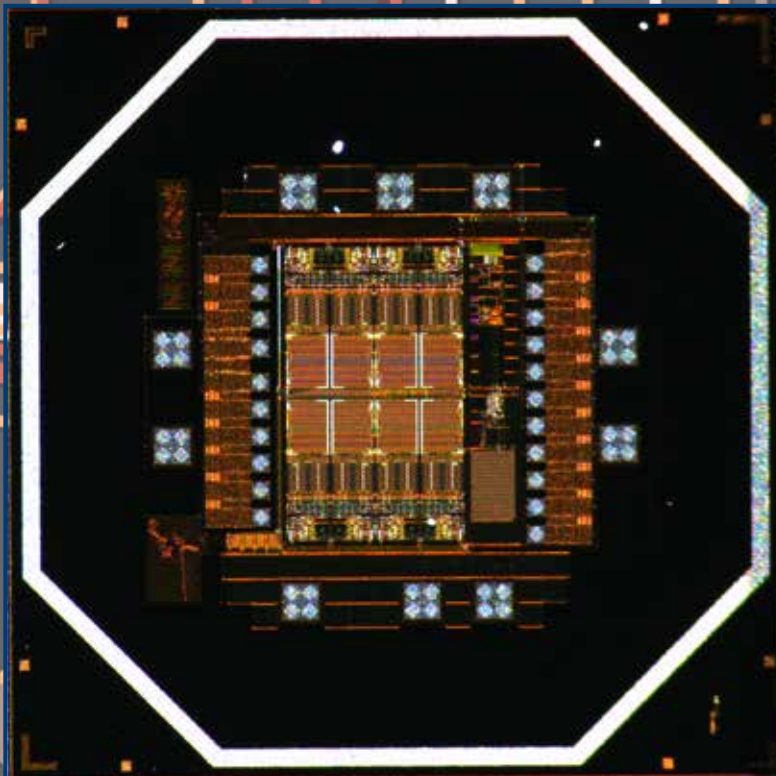

Lieuwe B Leene received BEng in electronic engineering from Hong Kong University of Science and Technology in 2011 and received MSc and PhD degrees in electronic engineering from Imperial College London in 2012 and 2016 respectively. He is currently a Research Associate at the Centre for Bio-inspired Technology, Department of Electrical and Electronic Engineering, Imperial College London. His research interests include low noise instrumentation systems, brain machine interfaces, data converters, and mixed signal processing techniques for biomedical applications.

Chip-photograph of an asynchronous BMI instrumentation system as part of the Empowering Next Generation Implantable Neural Interfaces (ENGINI) project

Kezhi Li, PhD

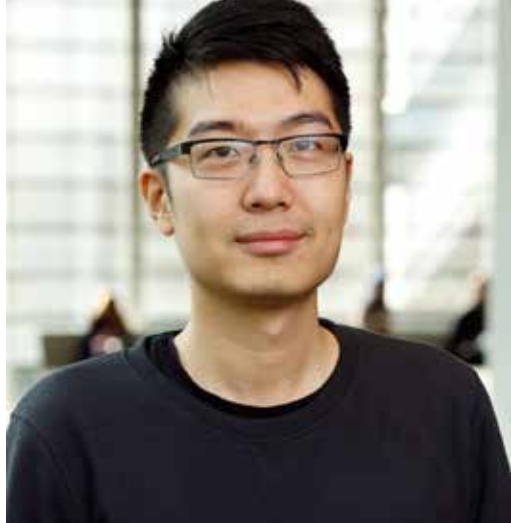

Kezhi (Kenneth) Li is currently a senior research associate at Bio-inspired Technology Centre, Imperial College London (ICL). His research interests include signal processing, machine learning and their applications in medical data processing, glucose time series analysis and quantum state tomography. He obtained the PhD degree ICL and BEng from University of Science and Technology of China (USTC). Before that he used to be a research scientist at Medical Research Council, a research associate at University of Cambridge, a research fellow at Royal Institute of Technology (KTH) in Stockholm and at Microsoft Research Asia (MSRA) and USTC.

The architecture of the proposed convolutional recurrent neural network for blood glucose prediction.

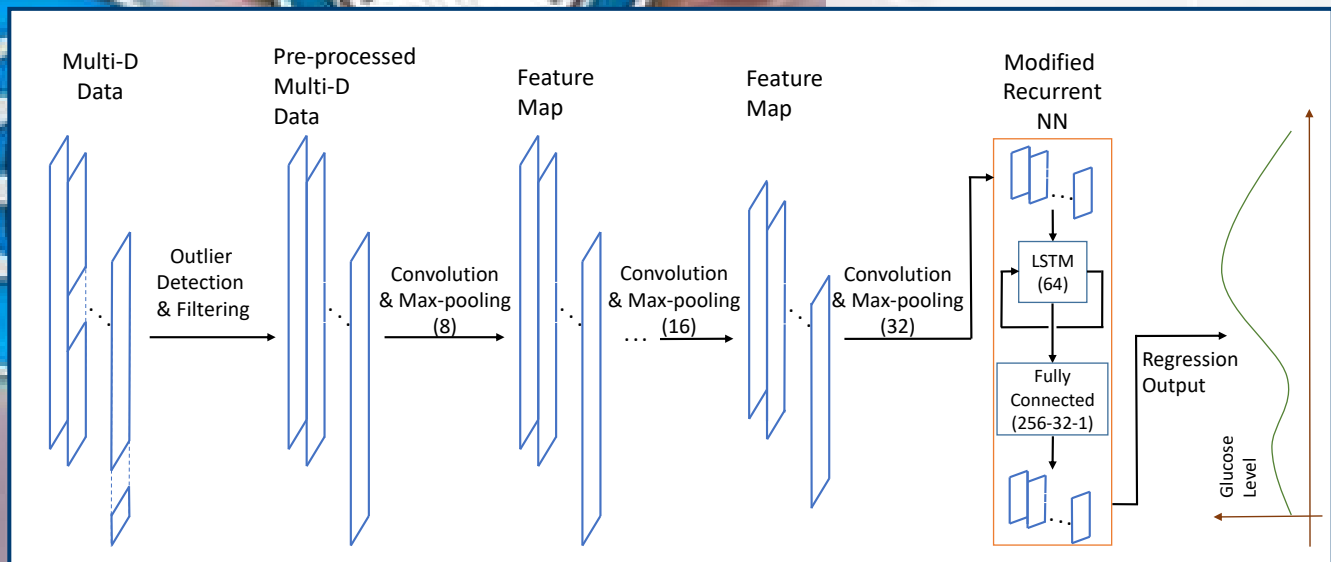

ASSOCIATE

www.imperial.ac.uk/people/chengyuan.liu12

Chengyuan Liu, PhD



Chengyuan Liu is a Research Associate at the Bio-Inspired Technology Centre, Department of Electrical and Electronic Engineering, Imperial College London. She received the PhD degree on Robust Control from Imperial College London, UK, in 2017, and the BEng degree on Automation from the Ocean University of China Qingdao College, China, in 2012. Her Research include robust control, optimization, predictive control, and their application in diabetes management and robotics.

PEPPER System



ASSOCIATE

www.imperial.ac.uk/people/s.de-mateo-lopez

Sara de Mateo Lopez, PhD



Sara de Mateo Lopez obtained Biology degree in 2006 from the Autonomous University of Barcelona and performed my PhD at the University of Barcelona, Spain. During her PhD thesis, she characterized the human sperm proteome of the whole cell and from isolated nuclei from infertile patients and controls. In 2011, she moved to California for a postdoctoral position in the University of California, Irvine (USA) with the purpose of describing the murine sperm metabolome and in 2016 she joined ICL as a Research Associate. She is currently developing novel chemistries for the detection and quantification of nucleic acids by isothermal amplification methods.

After extraction from blood samples, the DNA will be further treated with Bisulfite conversion to differentiate methylated versus unmethylated cytosines. Other alternative techniques such as Restriction Enzymes will also be considered. Treated DNA will be then amplified using isothermal nucleic acid amplification assays and data analyzed. According to the percentage of methylation of different gene promoters, personalized treatment will be provided. This approach will be eventually integrated in a benchtop instrument using ISFET-based CMOS technology to enable DNA methylation analysis in the clinic.

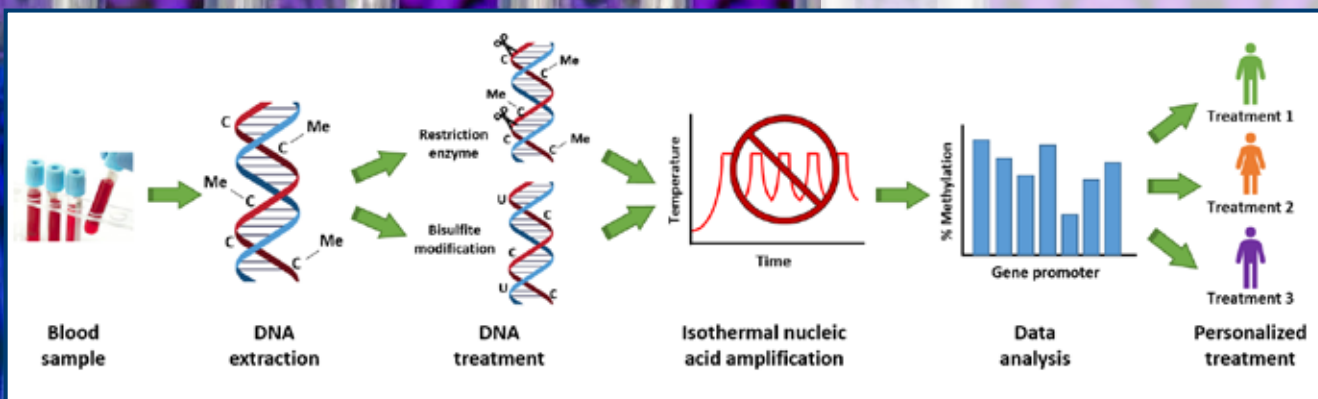



Katarzyna Szostak

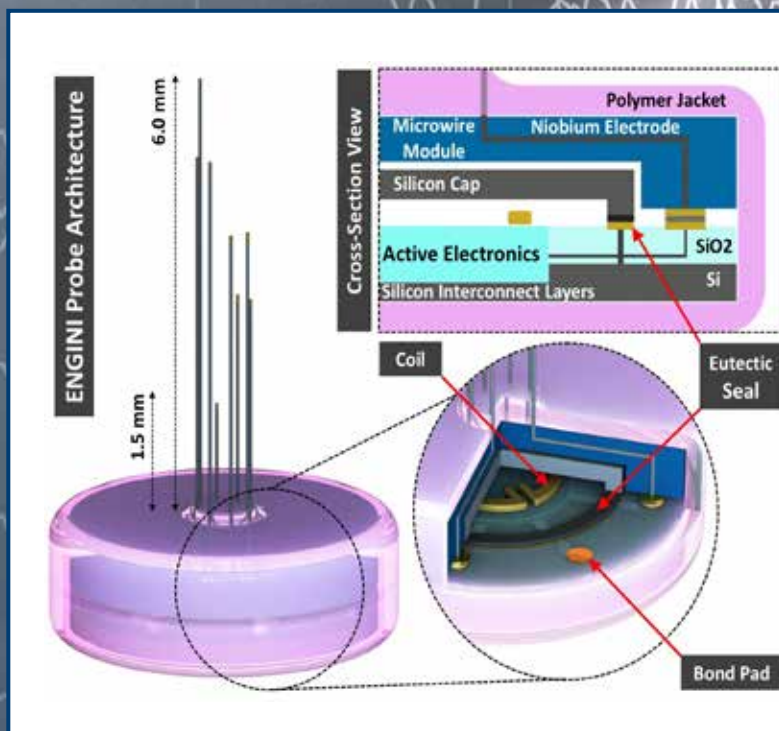

Kasia obtained her BSc in Electronics and Telecommunication (2011) and MSc in Microsystems, Electronics and Photonics (2012) from Wroclaw University of Technology, Poland. Her dissertations were focused on altering different aspects of microfabrication techniques- silicon etching processes and wafer bonding. Katarzyna’s research interests are focused on microfabrication technologies, she worked for research institutes and private companies across Europe (Poland, Germany, Belgium, and Finland) developing new processes, sensors and clean-room based solutions. In August 2015 Katarzyna has joined Neural Interfaces team where she is currently working on the minimum-footprint hermetic micropackaging for the next generation intracortical neural interfaces.

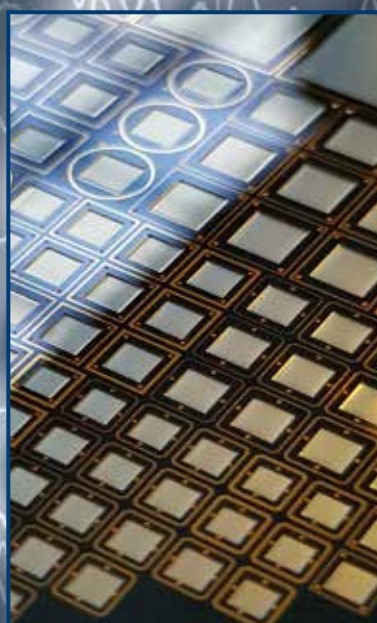

Top: ENGINI project probe construction concept including microwire array and hermetically micropackaged microelectronic module. Below: photograph of silicon wafer containing micropackage cavities surrounded by eutectic metal bonding frames.

ASSOCIATE

www.imperial.ac.uk/people/k.wildner

Krzysztof Wildner, PhD

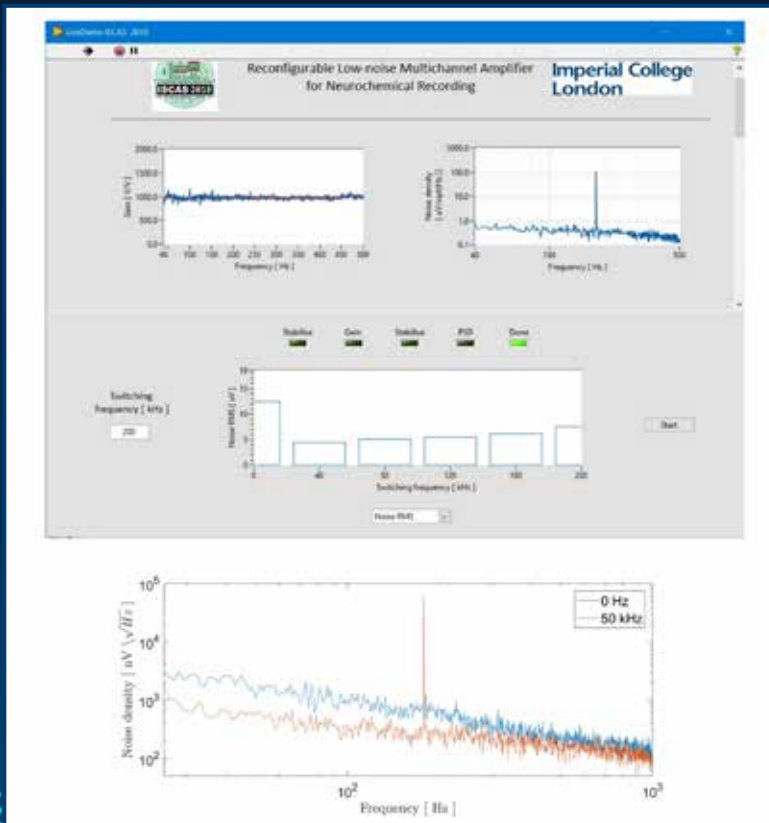

Krzysztof received MSc. degree in Automatic Control and Robotics in January 2009 (Warsaw University of Technology, Poland), followed by PhD (Faculty of Mechatronics, WUT) in the field of Biocybernetics and Biomedical Engineering in 2015. Currently he is employed at Warsaw University of Technology, Institute for Metrology and Biomedical Engineering, as an assistant professor. The main area of my professional work is focused on EMG and ENG recording and analysis and functional electrical stimulation. For few years now, he has been lecturing and leading laboratory classes closely related to functional electrical stimulation, fundamentals of neuro-muscular system architecture and EMG applications in biomedical engineering.

A LiveDemo platform: “Reconfigurable Low-noise Multichannel Amplifier for Neurochemical Recording”, presented during ISCAS 2018. Software GUI (up) and a graph showing the benefits of applying modified switching technique (down). Sharp spike visible refers to test signal ($50\mu\text{VRMS}$, 178Hz) used to estimate S/N ratio.

ASSOCIATE

www.imperial.ac.uk/people/longfang.zou

Longfang Zou, PhD

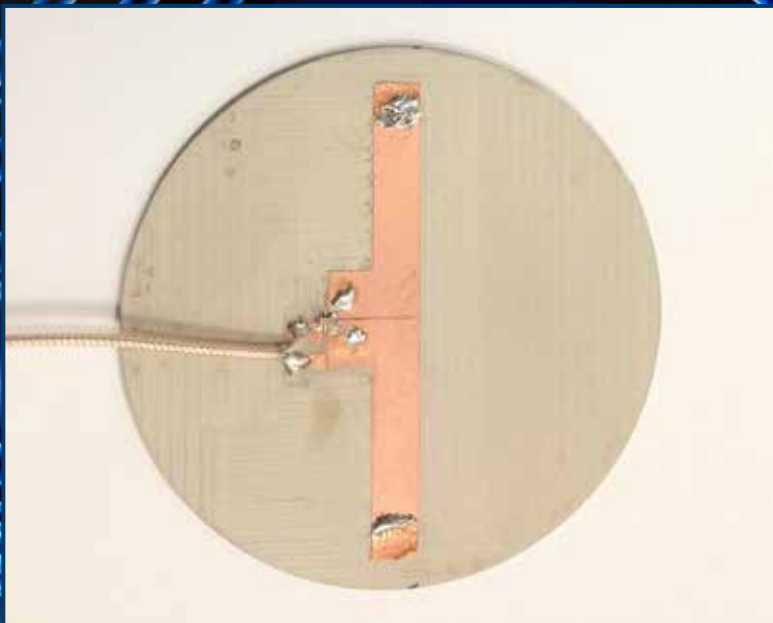

Longfang Zou received the Bachelor's degree in electrical and electronic engineering from University of Electronic Science and Technology of China, in 1999 and the Master and PhD degree in electrical and electronic engineering from the University of Adelaide, Australia in 2009 and 2013, respectively. He worked at the University of Bristol prior to joining the Centre of Bio-inspired Technology, Imperial College London in 2014. His research interests include antennas, antenna arrays, computational electromagnetics and biomedical devices.

Wearable dipole antenna with high impedance surface

Nur Ahmadi



Nur received the BEng degree in Electrical Engineering from Bandung Institute of Technology (ITB), Indonesia, in 2011 and the MEng degree in Communication and Integrated Systems from Tokyo Institute of Technology, Japan, in 2013. He then worked as a research and teaching assistant at the Microelectronics Centre and School of Electrical Engineering and Informatics, ITB, for 2.5 years. Currently, he is working toward PhD degree at the Next-Generation Neural Interface (NGNI) research group, within the Centre for Bio-inspired Technology.

(a) Block diagram of LFP-based BMI decoding using Long Short-Term Memory (LSTM) network (b) Performance comparison of proposed LFP-LSTM decoder (c) Examples of actual and decoded velocities.

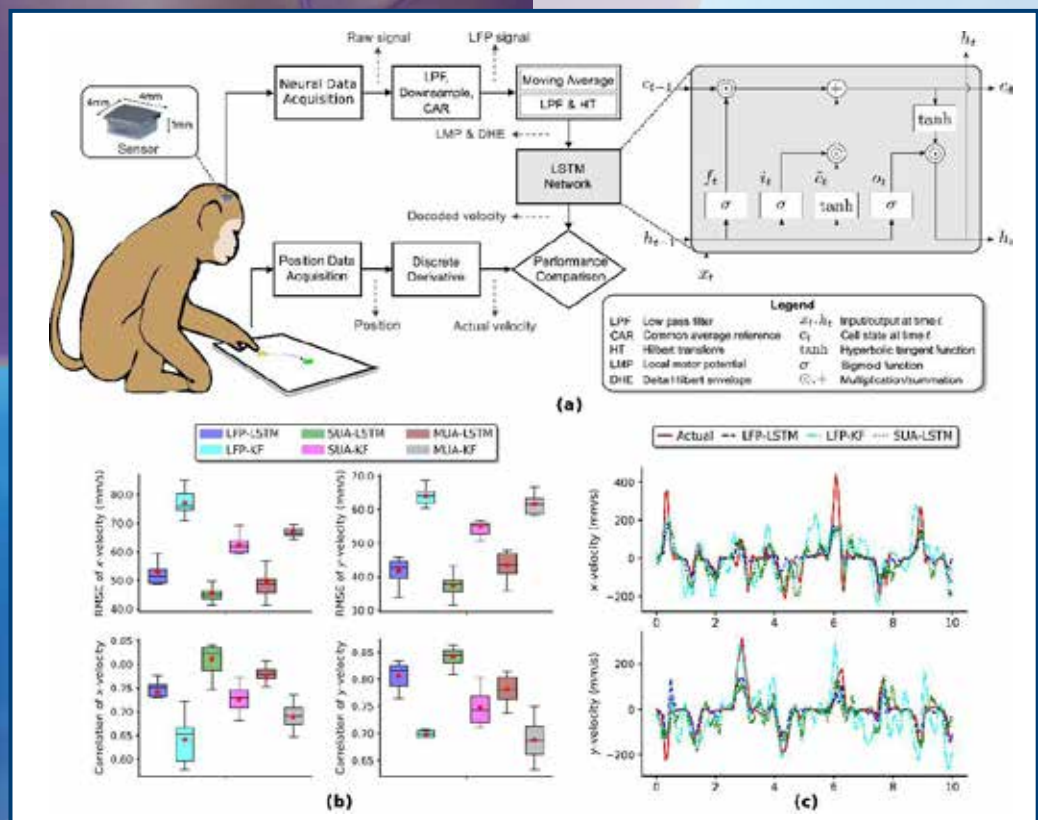

RESEARCH STUDENT & ASSISTANT

Miguel Cacho Soblechero

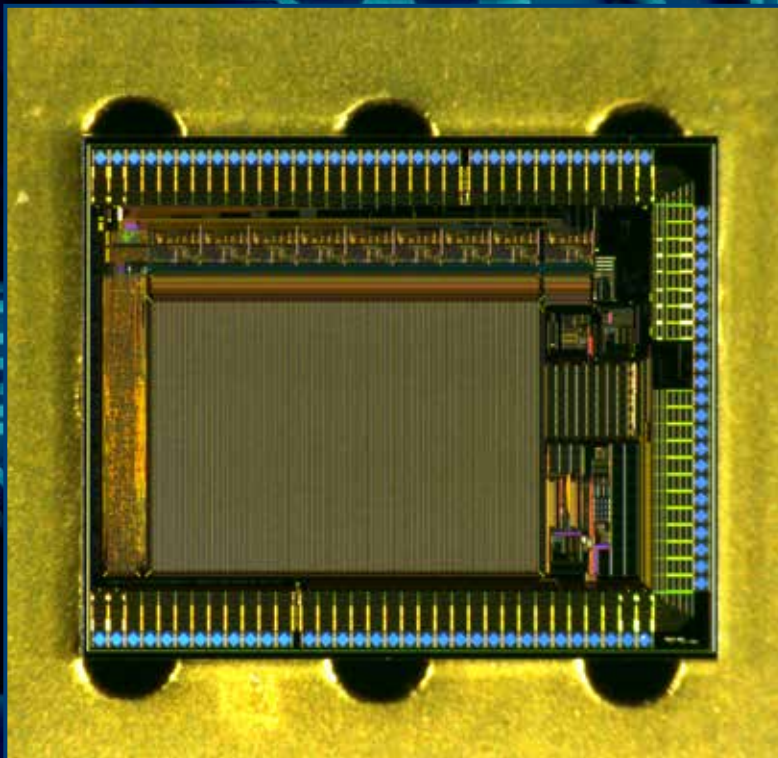

Miguel graduated in Electronic Engineering at University Carlos III of Madrid back in 2018. After undertaking a MSc in Analogue and Digital IC Design at Imperial, he worked in Industry for 3 years in several roles on Consultancy and Telecommunication. In 2017 he re-joined academia, starting his PhD at Imperial College London as part of the Centre of Bio-Inspired Technology. His research interest falls on the next generation of diagnostic platforms, looking at new ways of using CMOS technology to detect a wide range of diseases.

Photo of the tape-out carried this year

RESEARCH STUDENT & ASSISTANT

Matthew Cavuto



Matthew Cavuto completed his undergraduate studies at Massachusetts Institute of Technology, majoring in Mechanical Engineering and concentrating in Biomechanics and Biomedical Devices. Following graduation, he received a Marshall Scholarship, funding two years of graduate studies in the United Kingdom. Having recently finished a MSc in Biomedical Engineering at Imperial College London, he is remaining for another year to pursue an MPhil in Electrical and Electronic Engineering and continuing his research in the Next Generation Neural Interfaces Group at the Centre for Bio-Inspired Technology. His research focuses on the design and development of mechanically robust architectures and insertion methods for mm-scale wireless neural probes. Following his studies at Imperial College London, he will enter the Harvard-MIT Health Sciences and Technology (HST) Medical Engineering and Medical Physics (MEMPH) PhD Program.

3D rendering of ENGINI probe concept overlaid on design drawings of a novel insertion device for multi-microwire electrode neural probes (patent pending).

John S M Daniels



John is a Research Assistant and PhD candidate advised by Dr Pantelis Georgiou in the Metabolic Technology Lab. His research focuses on low-power wearable technologies, machine learning and diabetes technology. He received his M Eng in Electrical and Electronic Engineering with Management from Imperial College London in 2015.

The project involves the development of a system to promote the self-management of diabetes by optimizing glucose control by continuously monitoring important factors such as exercise and stress through physiological signals (heart rate, skin temperature, ambient temperature, etc.)

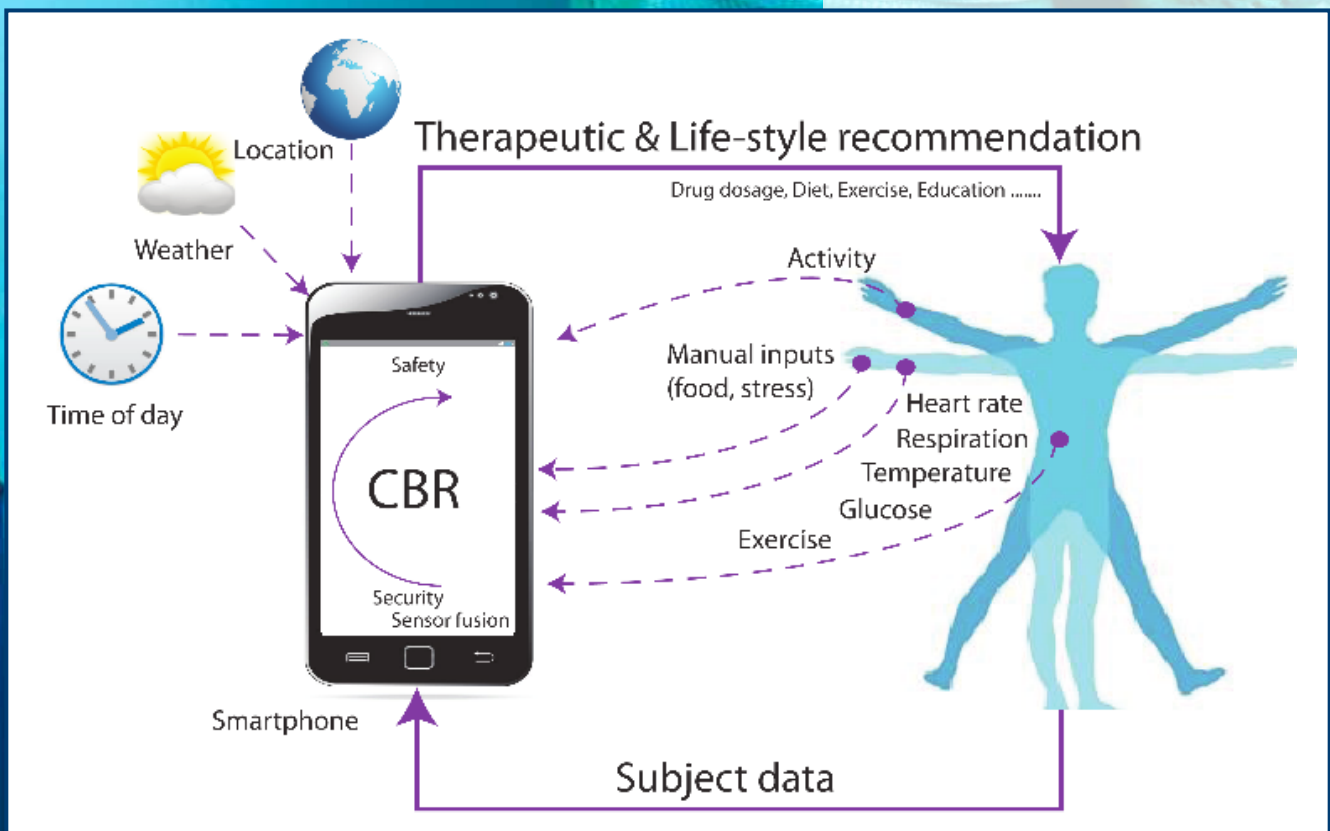

RESEARCH STUDENT & ASSISTANT

Matthew Douthwaite

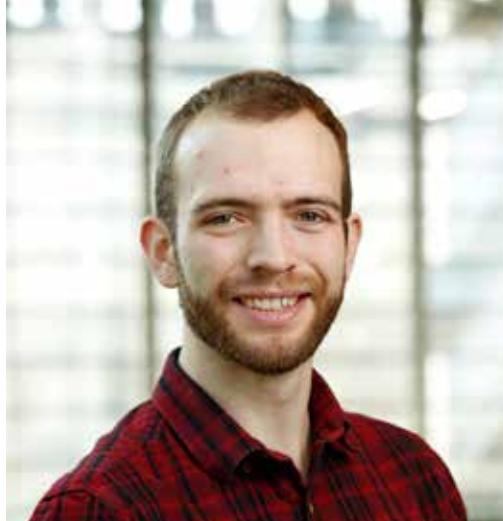

Matthew Douthwaite received the MEng degree in electrical and electronic engineering and the MRes degree in advanced computing from Imperial College London (ICL), London, UK, in 2015 and 2016, respectively. He is currently undertaking a PhD degree with the EPSRC Centre for Doctoral Training in High Performance Embedded and Distributed Systems, within the Centre for Bio-Inspired Technology, Department of Electrical and Electronic Engineering, Imperial College London. He received the Usmani Prize for Micro-electronics in 2014 for outstanding performance in examinations in micro-electronics. His research interests include the design of ultra-low power bio-inspired analogue integrated circuits, particularly for wearable applications and energy harvesting.

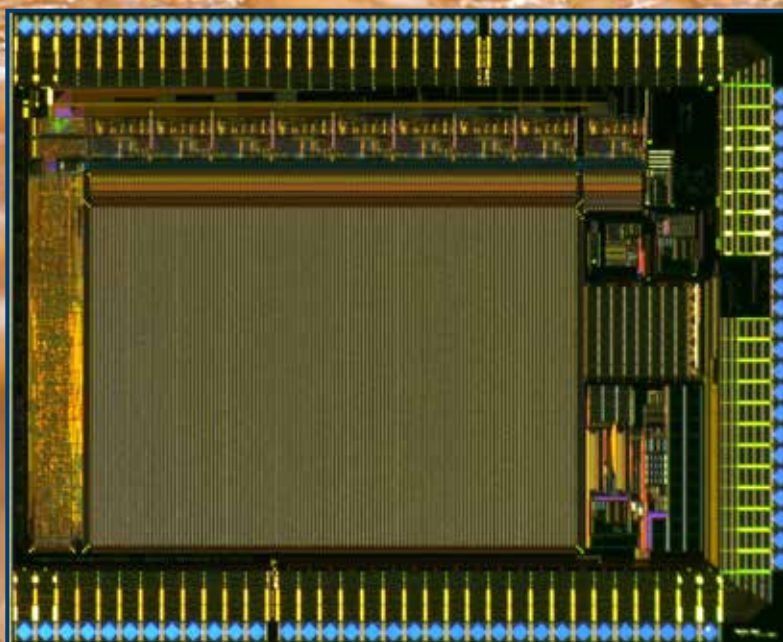

A fabricated $0.35\ \mu\text{m}$ CMOS IC containing the latest iteration of a low-power ISFET array for on-body electrochemical sensing. It features temperature compensation and auto-biasing circuits for robust measurements in a wearable device and consumes less than $30\ \mu\text{W}$.

Peilong Feng

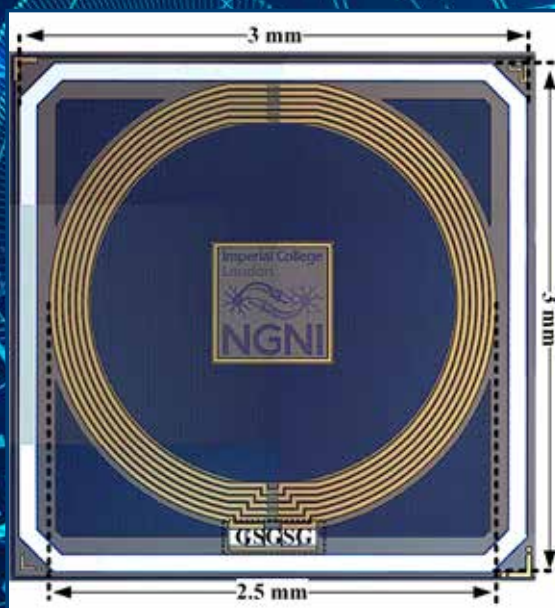
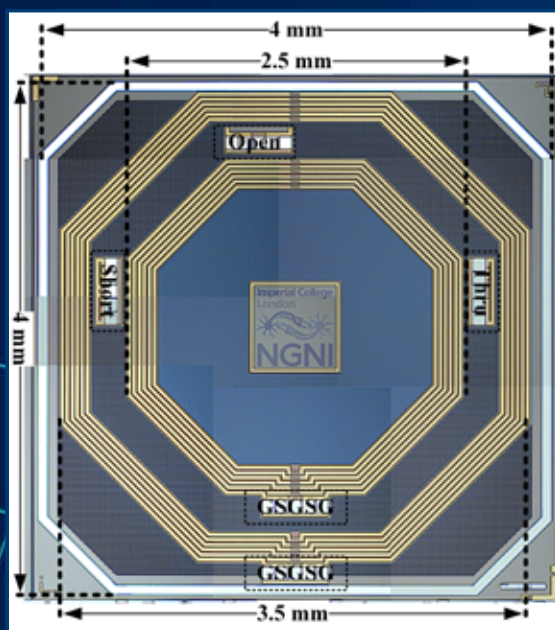
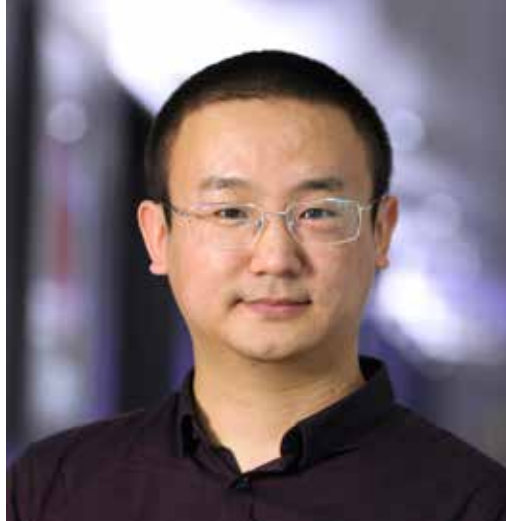

Peilong Feng received the BEng degree in electrical engineering from the Henan Polytechnic University, China, in 2011, the MSc degree in microelectronic systems design from University of Southampton, UK, in 2012, and the MSc degree in analogue and digital integrated circuit design from Imperial College London, UK, in 2015. He is currently pursuing the PhD degree in the Next Generation Neural Interfaces Lab at the Imperial College London. From 2012 to 2014, he worked as an electronic engineer in Shanghai Research Institute, China Coal Technology and Engineering group. He was the co-recipient of the Biomedical Circuits and Systems Conference (BioCAS) Best Paper Award in 2017.

1 mm-sized on-chip coils with NGNI logo for wireless power transfer and data communication

Amparo Guemes Gonzalez

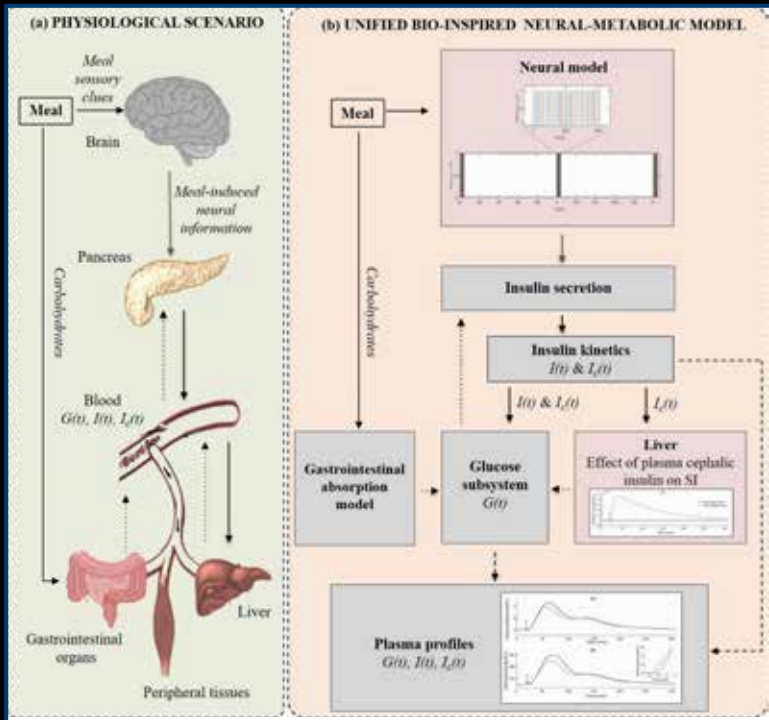

Amparo Güemes is currently a PhD student in the Centre for Bio-Inspired Technology at Imperial College London. She received the BSc degree in Biomedical Engineering from the Universidad Politecnica de Madrid (Spain, 2016) and the MSc degree Biomedical Engineering from Imperial College London (UK, 2017). Her interests lie in the fields of neuro-technology and diabetes treatment. She has worked in designing physiological models of the pancreatic secretion and bio-inspired glucose controllers for insulin and glucagon delivery. Her current research, Neuro Modulated Diabetes Control (NeuMeDic), focuses on studying the neural mechanisms that are involved in controlling glucose fluctuations with the aim of applying bioelectronics medicine for diabetes management.

(a) Physiological scenario. Diagram of the biological interaction among the most important organs involved in glucose control during meal intake. (b) Scheme of the unified bio-inspired neural-metabolic model. Each of the boxes represents one subsystem of the model. The pink shaded boxes depicts the novel subsystems introduced to the current metabolic models (grey shaded boxes). Insulin-related action and mass fluxes (solid black lines) and glucose-related action and mass flux (dotted black lines) are depicted to show the relationship among the blocks.

$I(t)$, $I_c(t)$, $G(t)$ and SI relate to plasma insulin, plasma cephalic insulin, plasma glucose and insulin sensitivity, respectively.

Dorian Haci



Dorian received both his BSc and MSc in Electronic Engineering at Polytechnic University of Turin, Italy, in 2012 and 2014 respectively. He was awarded a scholarship for developing the MSc thesis project at Imperial College London, where he designed and implemented an innovative thermally controlled system for biomedical-applications. After receiving his MSc, Dorian joined the Next Generation Neural Interfaces (NGNI) group at the Centre for Bio-Inspired Technology as a Research Assistant in 2015, working on implantable devices and brain-machine interfaces. Currently, he is also pursuing the PhD degree within the Circuit and Systems Group at the EEE Department, Imperial College London.

Concept of the multi-module implantable system (top); and (bottom) CANDO neural implant with multi-optrode brain interface

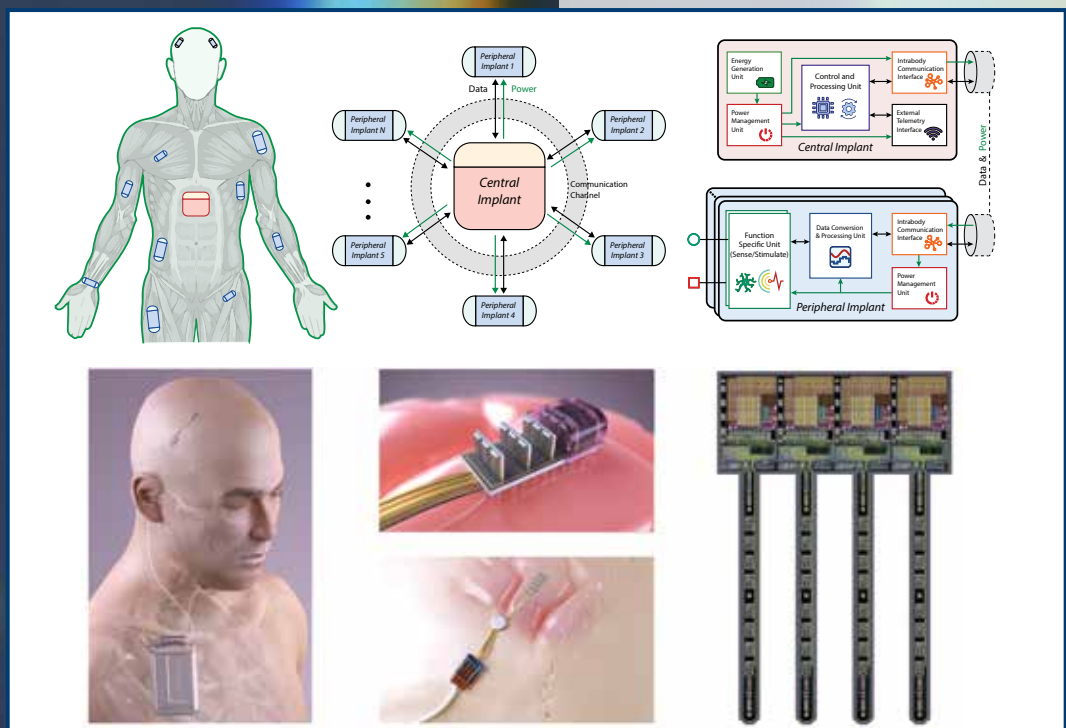

Bernard Hernandez Perez



Bernard Hernandez Perez is research assistant and PhD candidate at Imperial College London. His PhD topic is to design a clinical decision support systems that provides personalized, accurate and effective diagnostics at point of care. He received his BSc in Telecommunications and Computer Science from the University Rey Juan Carlos (URJC) in Madrid and his MSc in Machine Learning from the Royal Institute of Technology (KTH) in Stockholm.

EPiC IMPOC graphical summary. Diagram summarizing the key aspects and contributions of EPiC IMPOC. The diagram is composed of four main sections: the user interface (see image in the middle), the case-based reasoning module to facilitate data collection, patient review and inspection of past similar cases (see green background), the probabilistic inference module to provide step wise decision support (see yellow background) and the AMR surveillance module (see orange background). All this information is provided to clinicians to enhance decision making at the point of care.

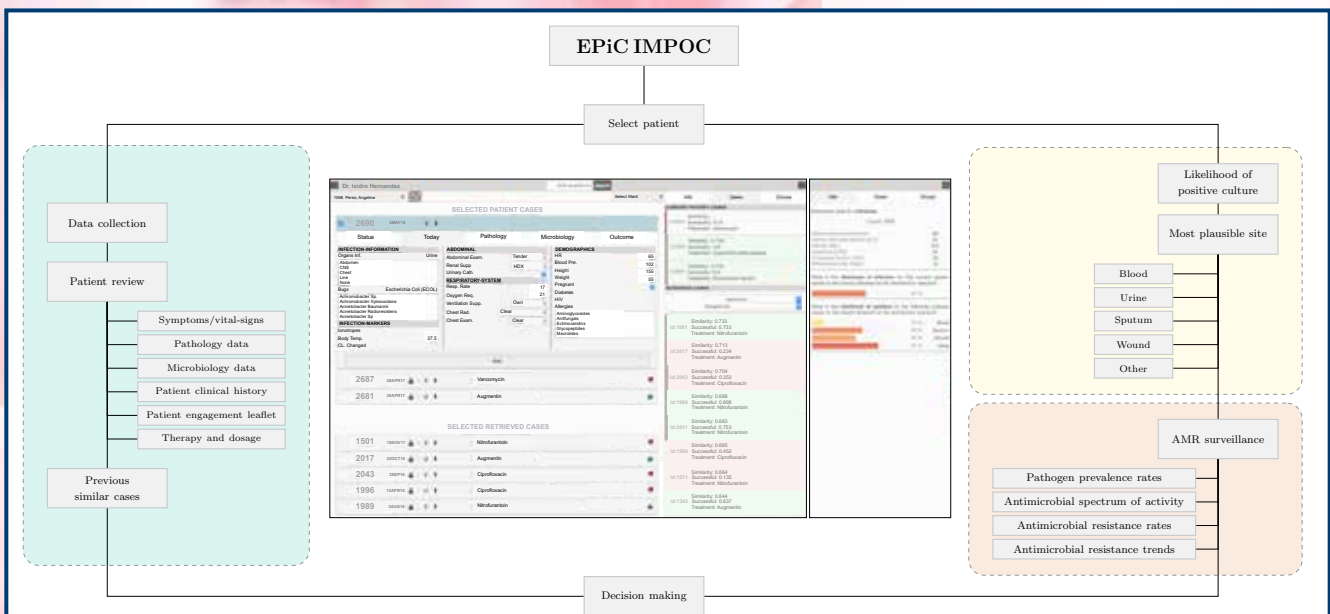

RESEARCH STUDENT & ASSISTANT

Bryan Hsieh



Bryan received MEng degree in Biomedical Engineering (EEE stream) from Imperial College London in 2016 and for his master thesis, he worked under Professor Emmanuel Drakakis developing hardware for ultrasound imaging. Specifically developing a low noise front-end PGA for ultrasound imaging as well as implementing a beamforming algorithm on a FPGA. He joined NGNI lab in 2016 and he is currently working in collaboration with Professor Nick Franks from Life Sciences on developing a closed loop neural-logging system to aid studies into REM sleep.

Final PCB prototypes ready to be sent off for component population

Timo Lauteslager

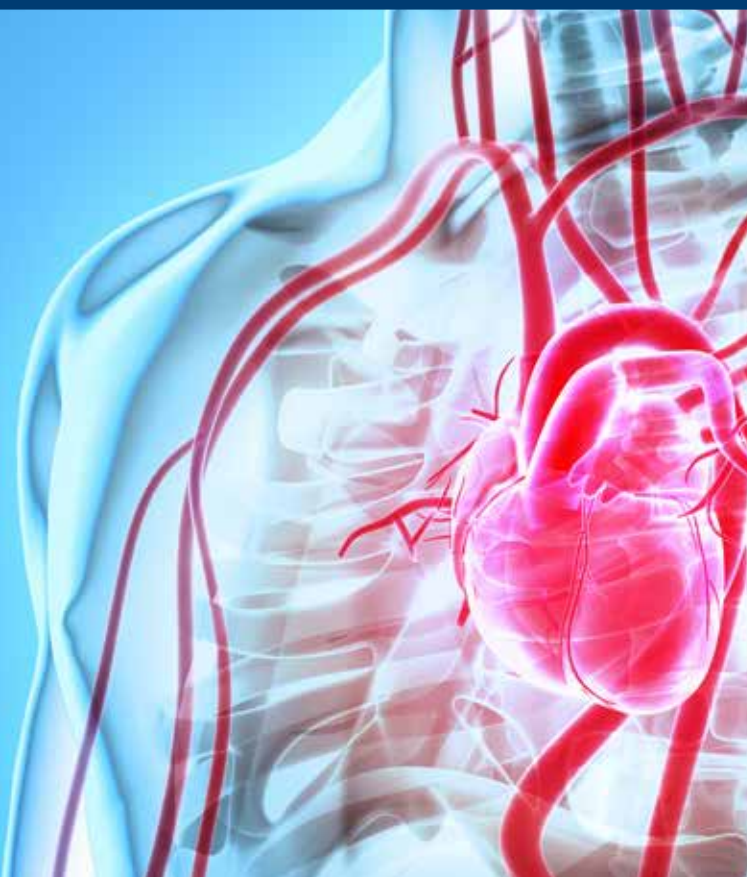

Timo Lauteslager received his BSc in Biomedical Engineering from the University of Twente, The Netherlands. Subsequently he was awarded with a two year Erasmus Mundus scholarship from the European Committee which allowed him to follow a joint degree master's programme in Biomedical Engineering, at Czech Technical University and Trinity College Dublin. In 2014 he received his MSc with distinction from both universities. Since then, Timo has joined the Neural Interfaces group at the Centre for Bio-inspired Technology as a PhD candidate in January 2015. His current work focusses on using coherent ultra-wideband radar on chip for medical sensing and imaging.

Schematic overview of sensing arterial dilation inside the body using coherent ultra-wideband radar-on-chip.

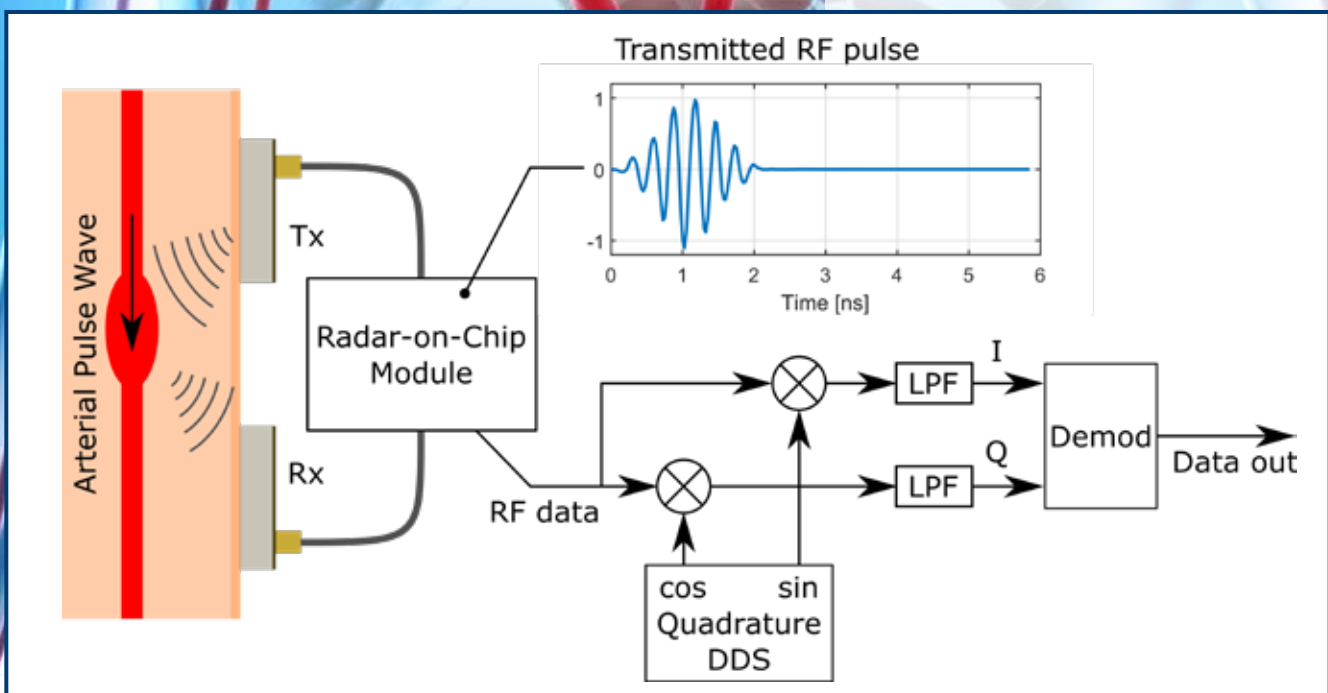

Kenny Malpartida Cardenas

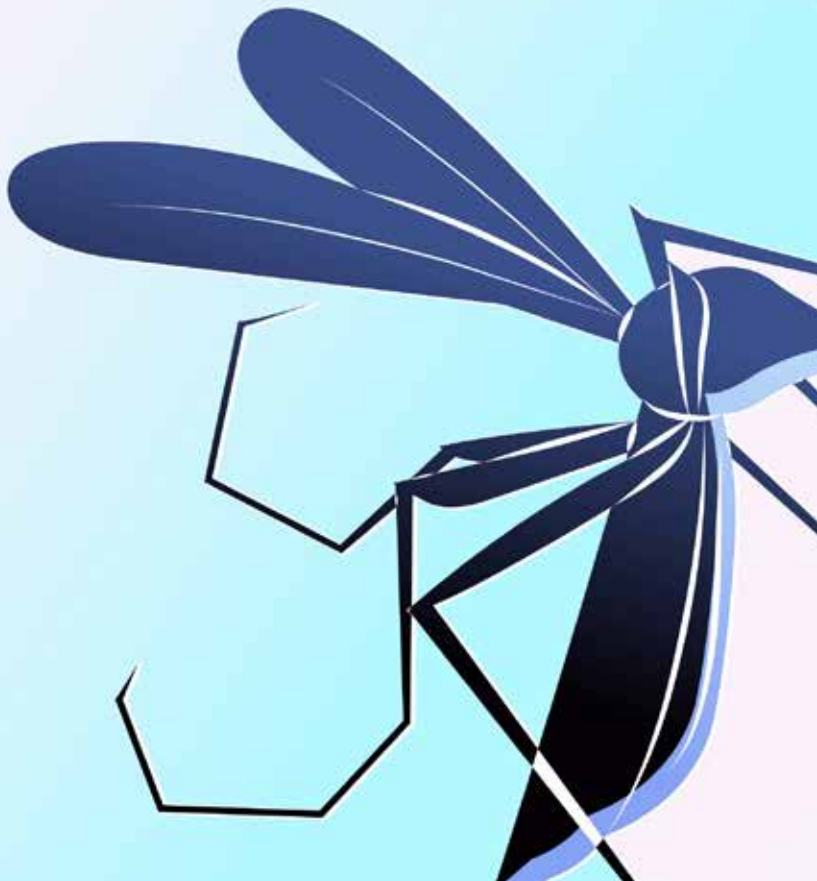

Kenny Malpartida received her BSc degree in Biomedical Engineering in 2016 from the Carlos III University of Madrid, Spain. In 2017, she obtained her MRes degree (Distinction) in Nanomaterials from Imperial College London. Currently, she is pursuing a PhD degree at the Centre for Bio-Inspired Technology as part of the High-Performance Embedded and Distributed Systems (HiPEDS) CDT. Her research focuses on the development of rapid point-of-care diagnostics for infectious diseases combining CMOS-based ISFETs biosensing technology and isothermal amplification methods, with special emphasis on malaria.

Mechanism of USS-sbLAMP. The incorporation of unmodified self-stabilizing (USS) competitive primers robustly delay or prevent unspecific amplification.

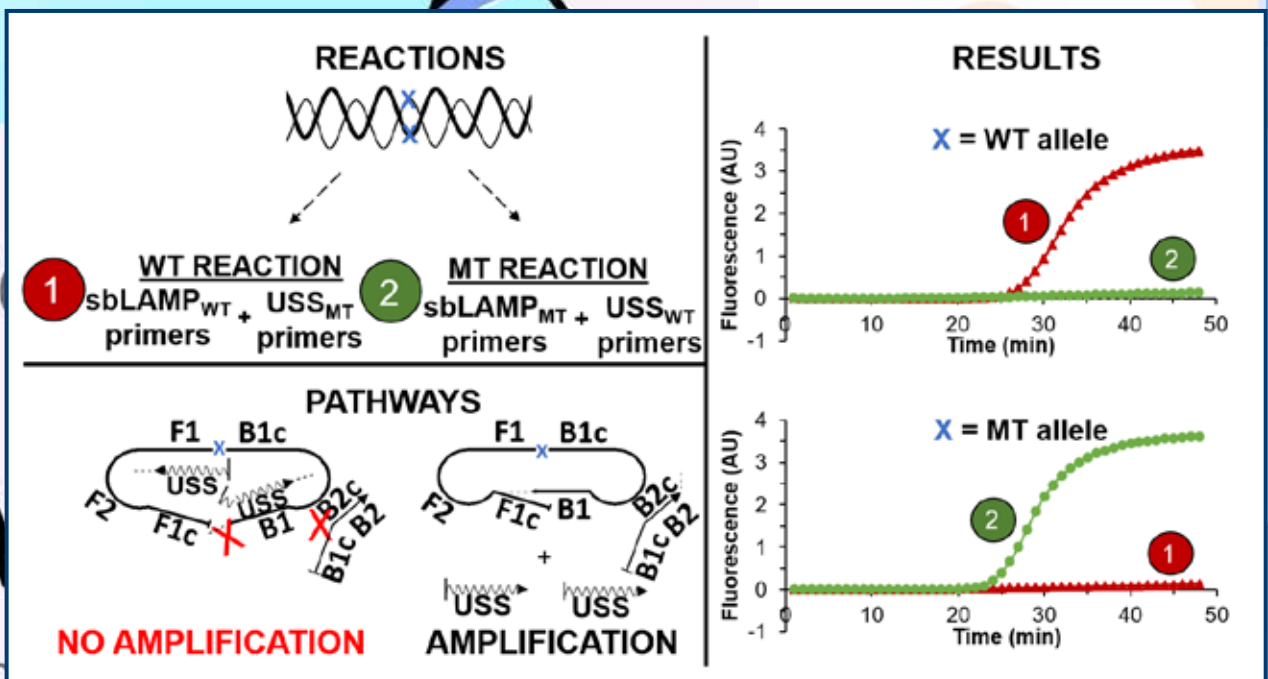

RESEARCH STUDENT & ASSISTANT

Michal Maslik



Michal Maslik received his MEng (Hons) degree in Electrical & Electronic Engineering from Imperial College London in 2016. He is currently working towards his PhD at the Centre for Bio-Inspired Technology (CBIT) mainly focusing on design of novel electronic circuits and techniques for next generations of neural implants. This includes work on better understanding of Continuous Time (CT) sampling as a possible method leading to highly efficient acquisition of neural signals exploiting their non-stationary nature. This has led to formulation of new theories related to CT sampling and development of electronic circuits implementing them such as a novel method of flicker noise suppression.

Layout of a novel CT acquisition circuit featuring stochastic flicker noise suppression

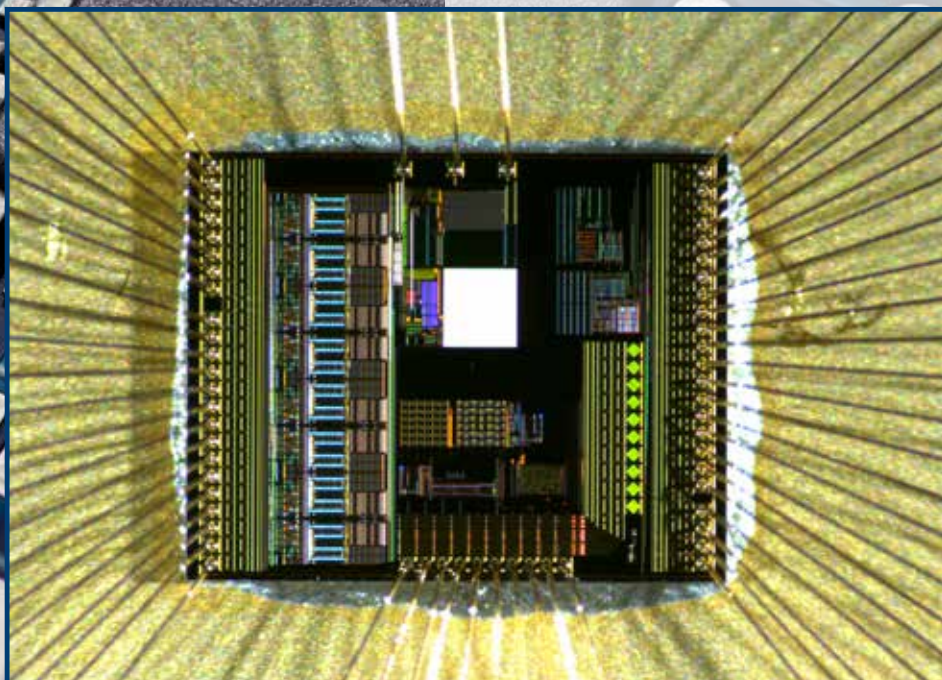

RESEARCH STUDENT & ASSISTANT

Federico Mazza

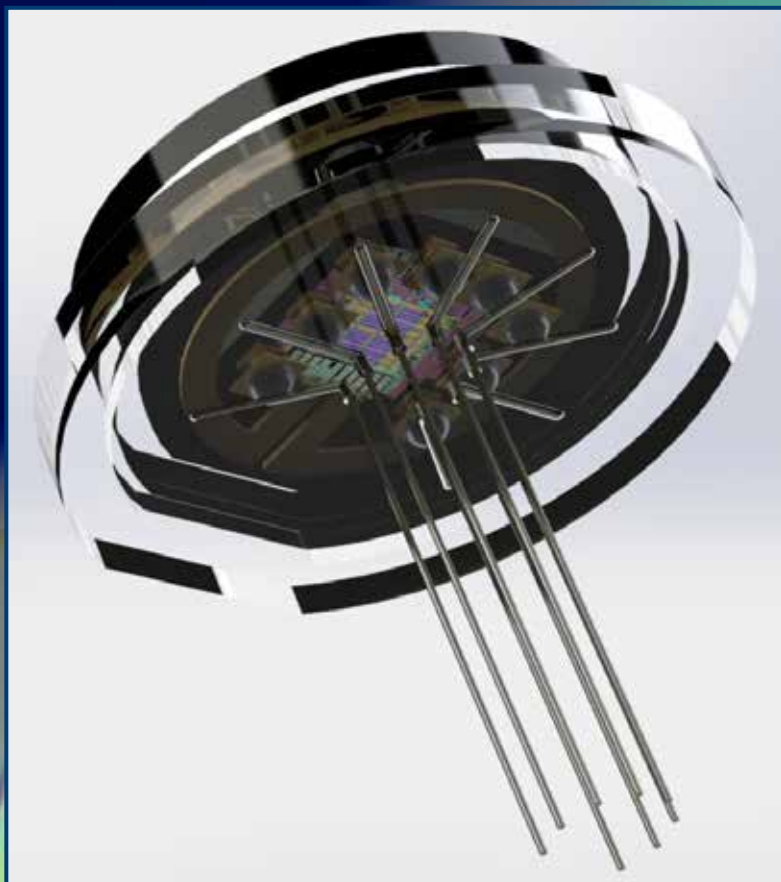

Federico obtained his BSc in Electronic Engineering from the Polytechnic University of Turin, Italy in 2012, followed by a double degree MSc program in collaboration with the University of Illinois at Chicago. He spent one year at UIC's Nanotechnology Core Facility, where he worked on the design of a new type of accommodative intraocular lens for cataract treatment. After working for one year in the field of industrial automation for the automotive industry, Federico joined Imperial College as a PhD student in January 2016 as part of the Next Generation Neural Interfaces group within the Centre for Bio-Inspired Technology.

Concept of millimetre-scale neural implant based on integration of hermetic glass micro-packaging and micro-wires

Khalid Baig Mirza



Khalid is a research assistant at the Centre for Bio-Inspired Technology, Institute of Biomedical Engineering. He completed his MSc in Analogue and Digital IC Design from Dept. of Electrical and Electronic Engineering, Imperial College London and started working as an Electronics Engineer for Ingenia Technology, in a product design team to implement a novel authentication technology called Laser Surface Authentication (LSA).

After 2.5 years at Ingenia, he returned to work and pursue a PhD at the Centre for Bio-Inspired Technology. He has successfully completed his PhD and is currently working under the ERC funded I2MOVE Synergy project, led by Professor Chris Toumazou and Professor Stephen Bloom, to develop an intelligent, implantable vagus nerve stimulator for obesity treatment. Previously he was also employed in a project funded by EPSRC aimed at real time sensing of neuro-chemical signals. His research interests lies in developing intelligent or closed-loop implantable or point-of-care platforms which can be used to deliver personalised therapy for obesity and related metabolic conditions.

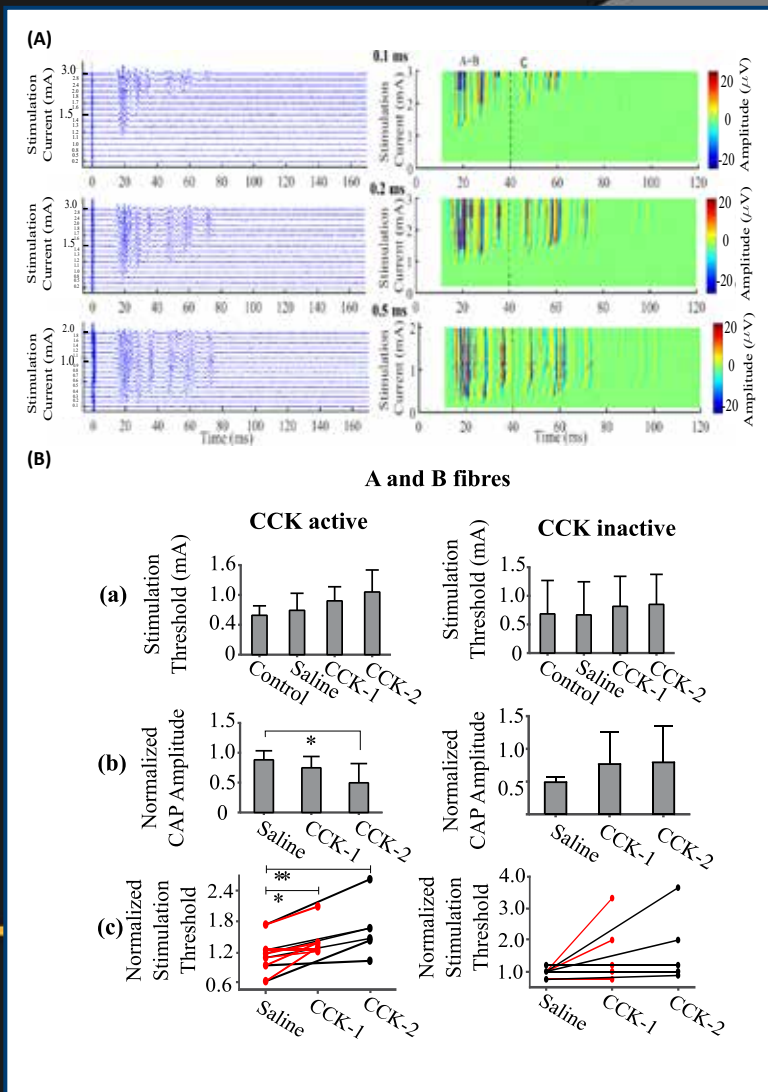

(A) Compound Nerve Action Potentials (CNAPs) observed on the sub-diaphragmatic vagus nerve, generated during stimulation of the left cervical nerve [1]. (B) Characterization of A and B fiber thresholds in the sub-diaphragmatic vagus nerve. An increase in normalized stimulation threshold due to injection of CCK of A and B fibers was observed in a rat animal model [1].

Nicholas Miscourides

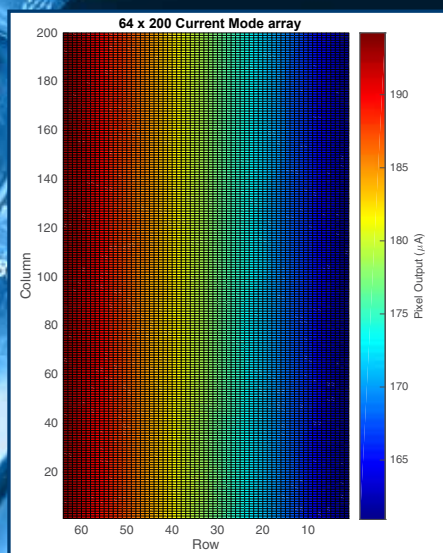
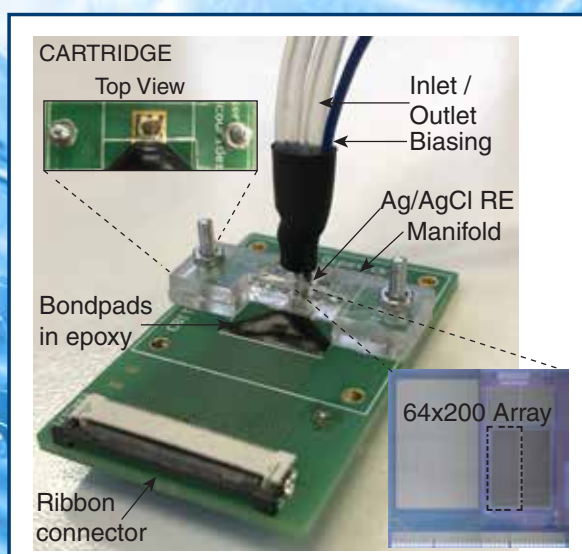

Nicholas Miscourides received the M. Eng. degree in Electrical and Electronic Engineering in 2014 and the M.Res. degree in Advanced Computing in 2015 both from Imperial College London, UK. He is currently working towards the PhD degree at the High-Performance Embedded and Distributed Systems (HiPEDS) EPSRC Centre for Doctoral Training and the Centre for Bio-inspired Technology, Department of Electrical and Electronic Engineering, Imperial College London, UK. His research interests include mixed-signal IC design for integrated chemical sensing in CMOS, large-scale ion imaging and optimization of chemical sensing for biomedical applications. He was the recipient of the Sir Bruce White Prize 2014 for the best M.Eng. project with a focus on analogue IC design and co-author of the Best Paper Award at ISCAS 2018.

(Top) Microfluidic manifold used to facilitate solution flow with integrated biasing on the surface of the TITANICKS chip.

(Below) Example output from the selected array being used to demonstrate the effect of current leakage on an RC node. This appears as a slow monotonic change which resembles a rainbow when plotted in 2D.

RESEARCH STUDENT & ASSISTANT

Nicolas Moser

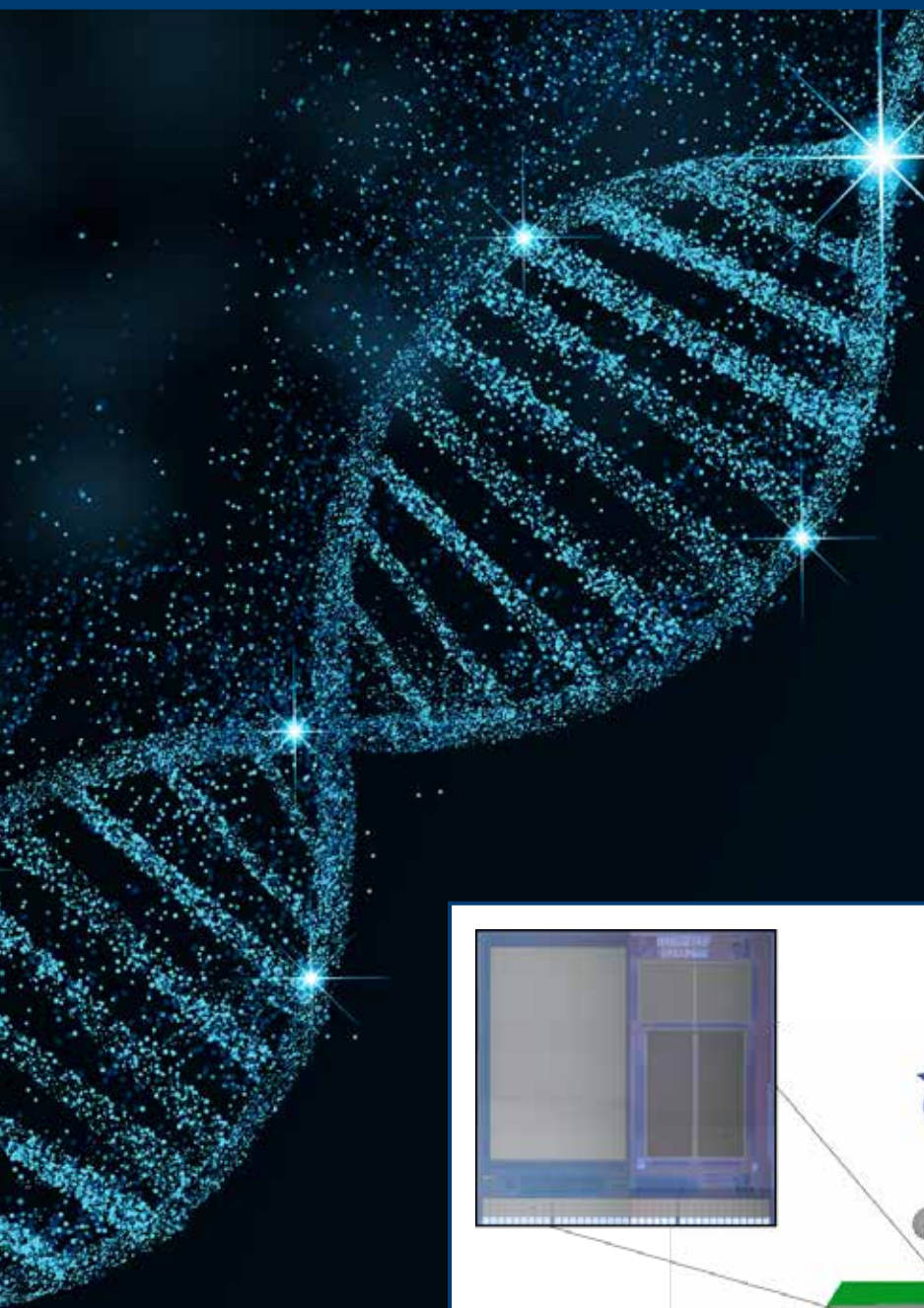

Nicolas is pursuing a PhD programme part of the Centre for Doctoral Training in High Performance Embedded and Integrated Systems (HiPEDS) and is awaiting his PhD defence after submitting his thesis. His work involves the design of CMOS sensing architectures encoding the chemical signal in time and arranged as very large arrays to perform ion imaging of chemical reactions. The research focuses on the development of a Point-of-Care device for the rapid diagnosis of infectious diseases such as dengue and malaria in tropical countries, connecting to a back-end server for early detection of epidemics outbreak. He has been awarded an EPSRC Doctoral Prize Fellowship to continue his work next year.

More than 4000 sensors on the CMOS microchips are used to detect the presence of pathogen DNA or RNA

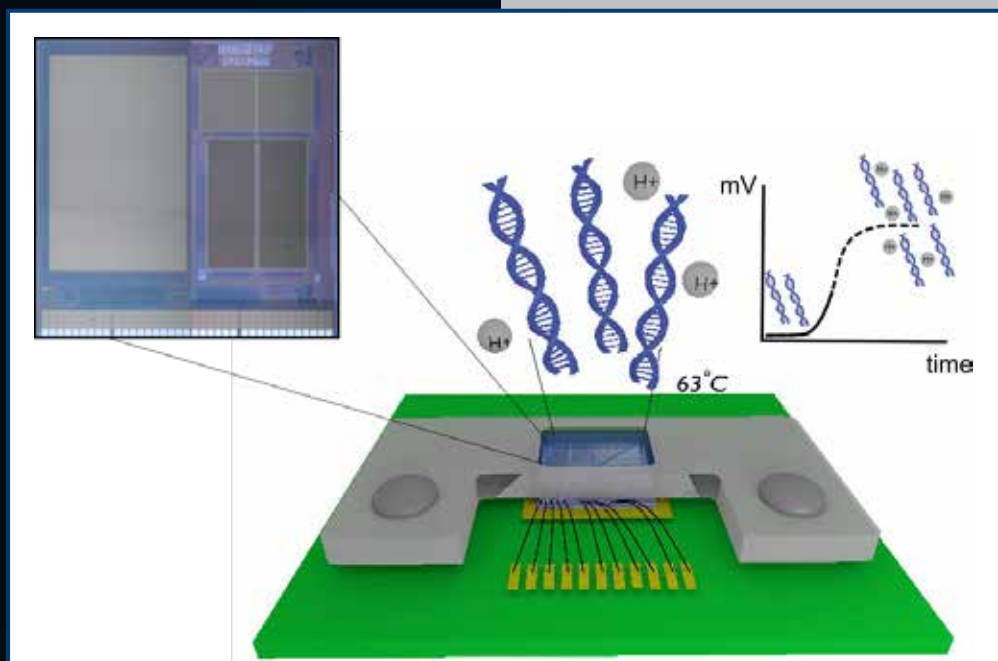

Christoforos Panteli

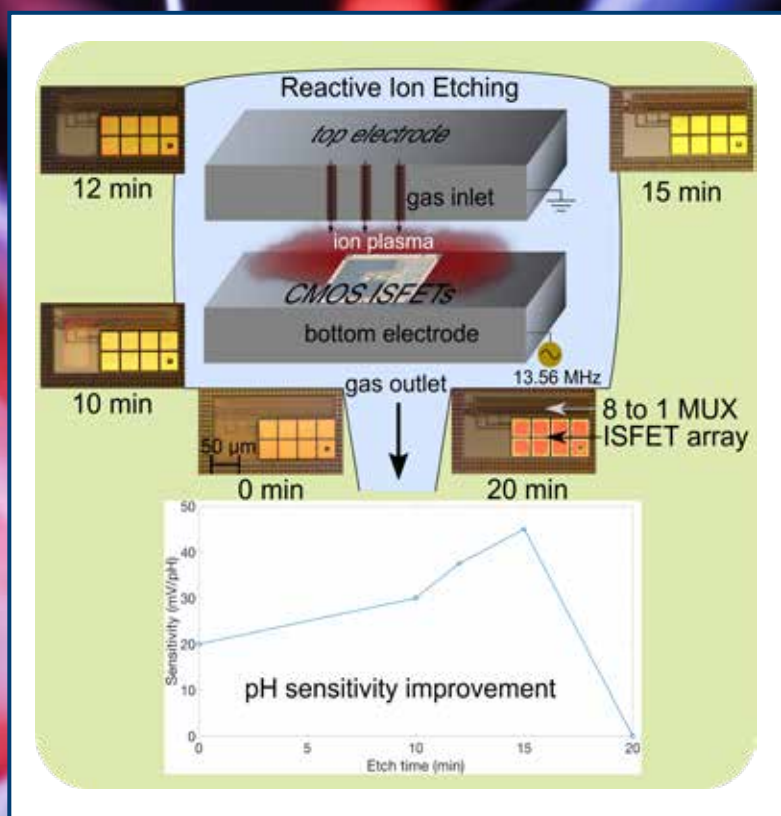

Christoforos Panteli received the MEng degree in electrical and electronic engineering from Imperial College London of Science, Technology and Medicine, London UK in 2015 with first class honours. He then started his PhD studies in the Optical and Semiconductor Devices Group in collaboration with the Centre of Bio-Inspired Technology in the department of Electrical and Electronic Engineering of Imperial College London under the supervision of Dr K Fobelets and Dr P Georgiou. He has passion for applied physics and his main interests are the design and fabrication of micro- and nano-fabricated devices and systems for biomedical and environmental applications. He is currently in the final year of his PhD studies and mainly working on graphene-based biomedical sensors. Christoforos Panteli is a member of the Institute of Engineering and Technology and the Electrochemical Society.

Performance improvement of commercial ISFET sensors using reactive ion etching

RESEARCH STUDENT & ASSISTANT

Adrien Rapeaux



Adrien Rapeaux is a graduate engineer from Phelma school of Engineering in Grenoble, France, currently pursuing a final year in the High Performance Embedded and Distributed Systems PhD Programme. He developed a nerve fiber size-selective stimulation algorithm combining conventional stimulation and high frequency block and is designing a tool to demonstrate it ex-vivo in the rat sciatic nerve.

Previous achievements include designing the stimulator module in a system on chip fabricated for multi-university project Senseback and completing a one-year internship in neuroprosthetics company Galvani Bioelectronics.

Cuff electrode used in preliminary rat sciatic nerve experiments in partnership with Newcastle University

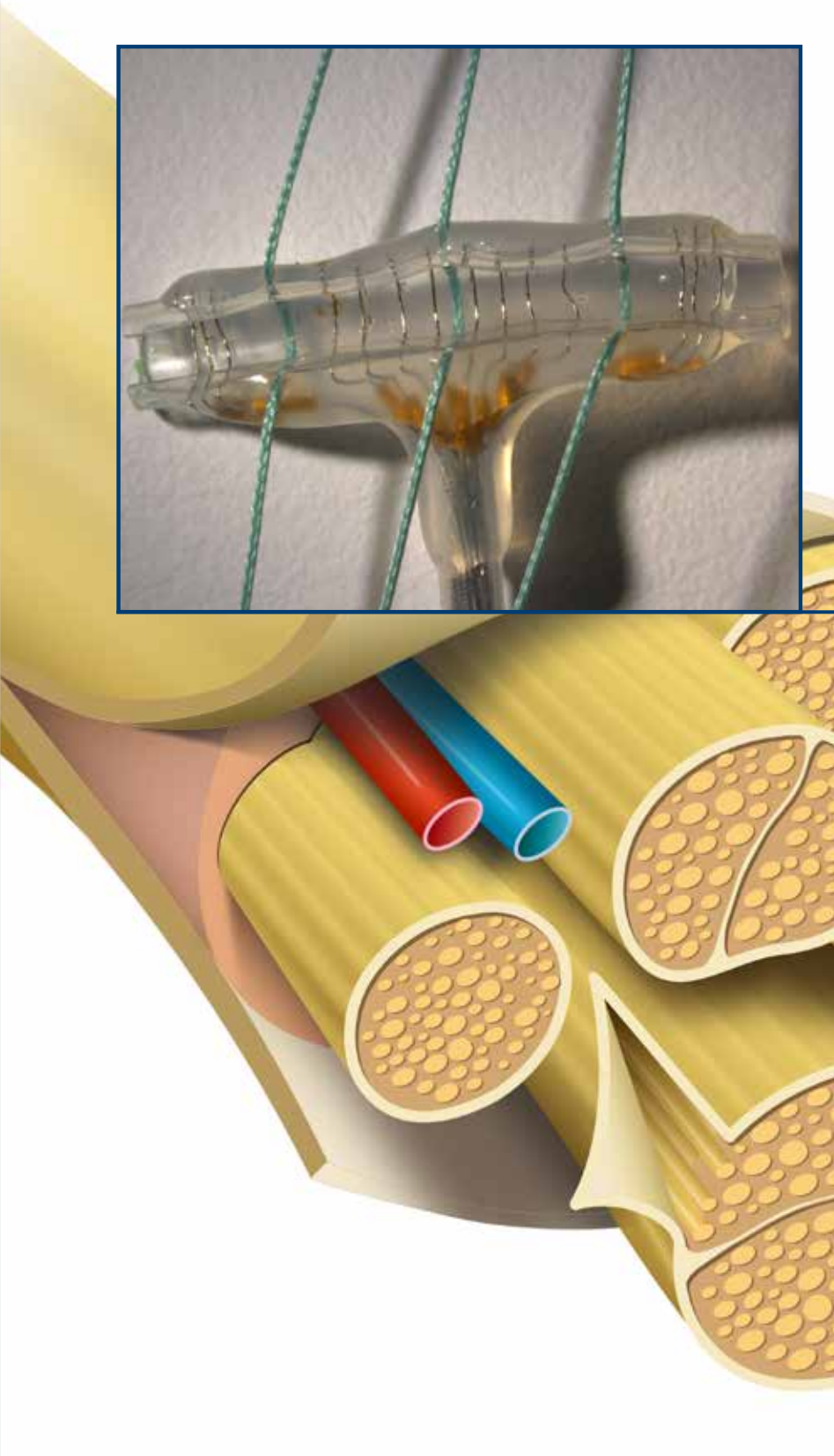

RESEARCH STUDENT & ASSISTANT

Francesca Troiani

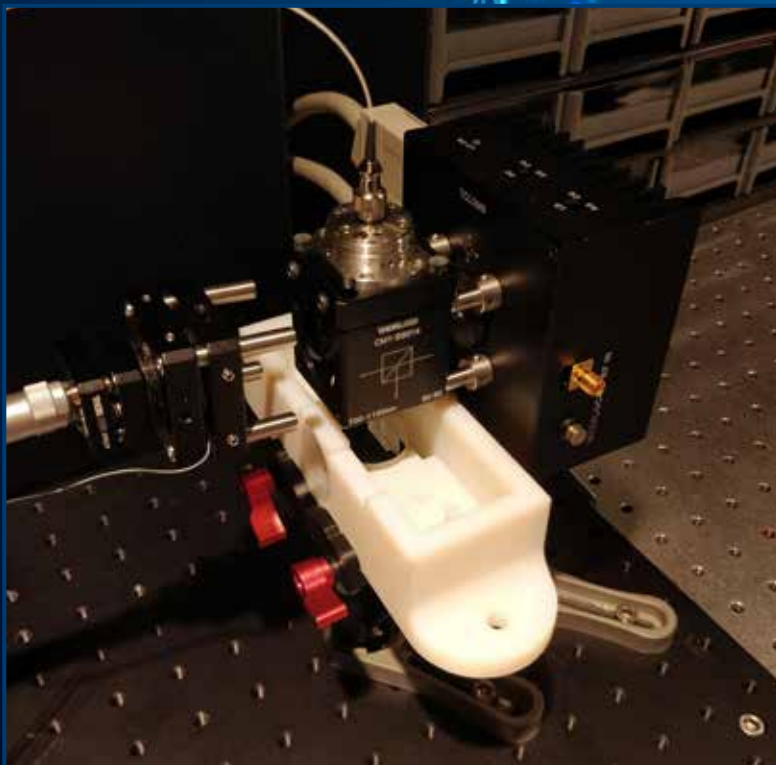

Francesca received her BSc in Physics in 2011 and her MSc in Nuclear and Medical Physics in 2013, both from University of Trieste, Italy. She was then awarded a postgraduate fellowship from SISSA to continue her MSc project work on grid cells and computational model for formation of spatial representations on hyperbolic surfaces. Francesca has joined the Next Generation Neural Interfaces group as a PhD candidate in August 2014. She has been awarded an EPSRC Doctoral Prize Fellowship during which she will continue her work on optical neural interfaces and organise public engagement events and activities for the NGNI group.

Optical Coherence Tomography test setup. The white box is the sample chamber for the peripheral nerve.



Siwei Xie

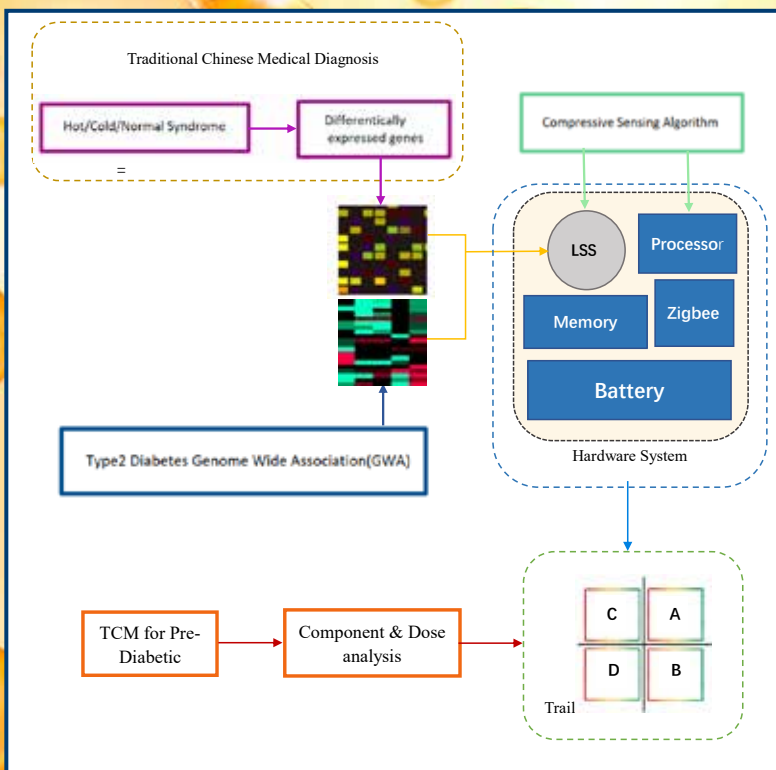
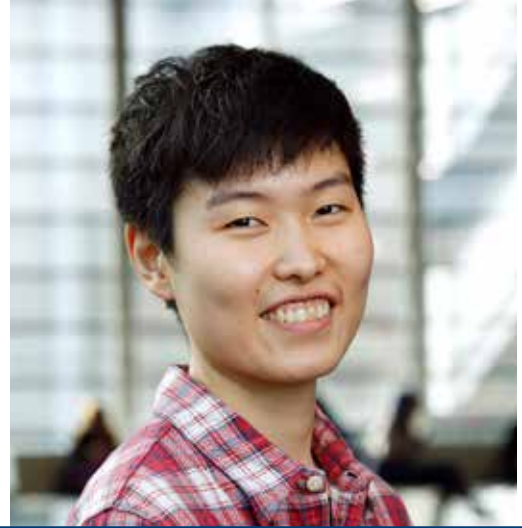

Siwei Xie received the MSc degree in Electrical and Electronic Engineering from the University of Leicester (UK) in 2015. She then spent one year as a Research Engineer at CapitalBio, an innovative Biomedical healthcare company in Beijing, China. In 2016, she joined the Centre for Bio-inspired Technology, Department of Electrical and Electronic Engineering, Imperial College London. As a PhD student, she is under Professor Toumazou's supervision and her main research interests focus on Biomedical applications based on low powered, LSS Imaging System design and personal healthcare.

A low powered embedded system design with lensless image sensor in the applications of Type 2 Diabetes GWA recognition and TCM Syndrome GWA differentiation

Junming Zeng

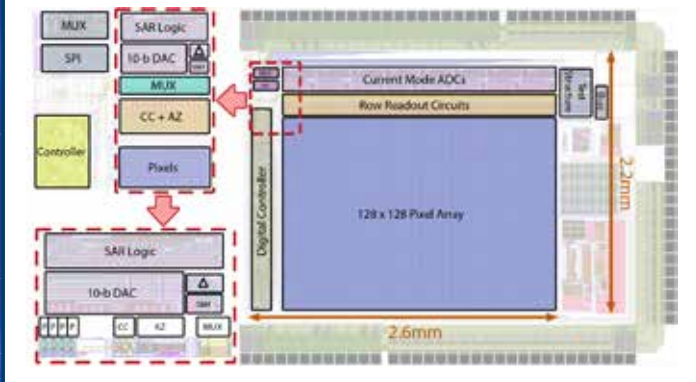
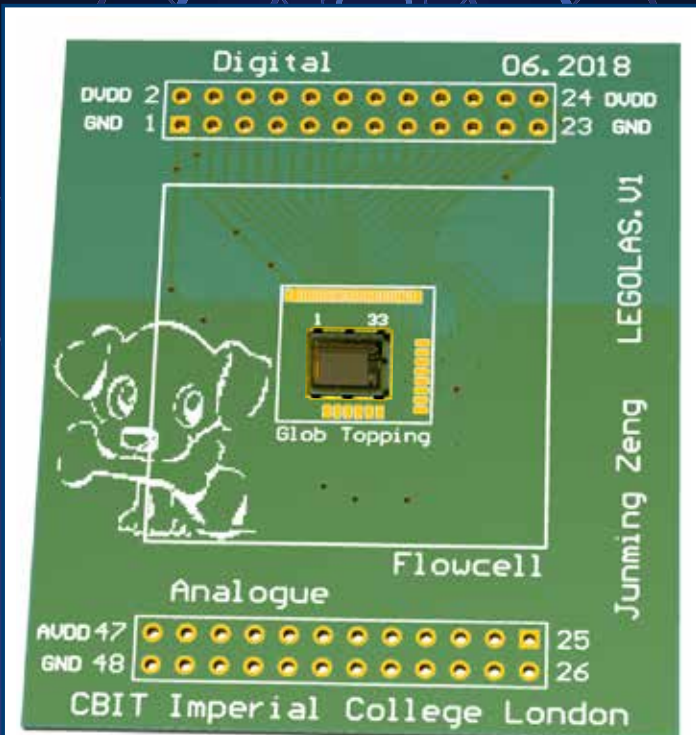

Junming Zeng received the BEng degree in Electronic Engineering with first class honours degree from University of Southampton in 2016, and the MSc degree in Analogue and Digital Integrated Circuit Design with distinction from Imperial College London in 2017. He is currently working towards the PhD degree at Centre for Bio-Inspired Technology, Department of Electrical and Electronic Engineering, Imperial College London. His research focuses on ultra-high speed mixed-signal system-on-chip platforms. Specifically, he is developing the next generation ion imaging platform offering novel spatiotemporal resolution. He was the recipient of the Student Best Paper Award first prize at ISCAS2018 Florence, Italy.

A microchip containing an array of 128 by 128 ISFET pixels with current mode signal processing circuits achieving an ultra-high frame rate of 3000fps. It is fabricated in 0.35um CMOS technology and assembled onto the PCB for real-time lab-on-chip ion imaging.

Publications

- A Au, N Moser, J Rodriguez-Manzano, P Georgiou, "Live demonstration: a mobile diagnostic system for rapid detection and tracking of infectious diseases", *2018 IEEE International Symposium on Circuits and Systems (ISCAS)*, Florence, Italy, pp. 1–1, 2018
- A Moniri, J Rodriguez-Manzano, P Georgiou, "A framework for analysis of real-time nucleic acid amplification data using novel multidimensional standard curves", *bioRxiv*, p.379180, 2018
- A Rapeaux, E Brunton, K Nazarpour, T G Constandinou, "Preliminary Study of Time to Recovery of Rat Sciatic Nerve from High Frequency Alternating Current Nerve Block", In *2018 40th Annual International Conference of the IEEE Engineering in Medicine and Biology Society (EMBC)* (pp. 2671–2674). IEEE
- A Rapeaux, K Nikolic, I Williams, A Eftekhar, T Constandinou, "Fiber size-selective stimulation using action potential filtering for a peripheral nerve interface: a simulation study", *Proc. IEEE EMBS Conference*, pp. 3411–3414, 2015
- B Hernandez, P Herrero, T M Rawson, L S P Moore, B Evans, C Toumazou, A H Holmes, P Georgiou, "Supervised learning for infection risk inference using pathology data. BMC medical informatics and decision making", *17(1):168*, 2017
- C H Chen, M Karvela, M Sohbaty, T Shinawatra, C Toumazou, "PERSON-Personalized Expert Recommendation System for Optimized Nutrition" *IEEE transactions on biomedical circuits and systems*, *12(1)*, pp.151–160, 2018
- C Liu, N Oliver, P Georgiou, P Herrero, "Glucose Forecasting Using A Physiological Model and State Estimation", *Conference on Advanced Technologies and Treatments for Diabetes*, 2018.
- D Haci, Y Liu, K Nikolic, D Demarchi, T G Constandinou, P Georgiou, "Thermally Controlled Lab-on-PCB for Biomedical Applications", *Proc. IEEE Biomedical Circuits and Systems Conference (BioCAS)*, pp. 655–658, 2018
- D Haci, Y Liu, S S Ghoreishizadeh, T G Constandinou, "Design Considerations for Ground Referencing in Multi-Module Neural Implants", *Proc. IEEE Biomedical Circuits and Systems Conference (BioCAS)*, pp. 563–566, 2018
- D Ma, J Rodriguez-Manzano, S de Mateo Lopez, M Kalofonou, P Georgiou, C Toumazou, "Adapting ISFETs for Epigenetics: An Overview", *IEEE Trans Biomed Circuits Systems*, vol. *12(5):1186–1201*, 2018
- E Perra, A Rapeaux and K Nikolic: "The Crucial role of Nerve Depolarisation in High Frequency Conduction Block in Mammalian Nerves: Simulation Study", *IEEE Engineering in Medicine and Biology Society (EMBS)*, 1–4, 2018
- F Mazza, Y Liu, N Donaldson, T G Constandinou, "Integrated devices for micro-package integrity monitoring in mm-scale neural implants", *Proc. IEEE Biomedical Circuits and Systems Conference (BioCAS)*, pp. 295–298, 2018
- F Troiani, K Nikolic, T Constandinou, "Simulating optical coherence tomography for observing nerve activity: a finite difference time domain bi-dimensional model", *PLoS ONE*, *13*, 2018
- I Williams, A Rapeaux, Y Liu, S Luan, T G Constandinou, "A 32-Channel Bidirectional Neural/EMG Interface with on-Chip Spike Detection for Sensorimotor Feedback" *Biomedical Circuits and Systems Conference (BioCAS)*, 2016 IEEE. (In proceedings)
- J Chen, K Li, T Herrero, P Zhu, "Dilated Recurrent Neural Network for Short-Time Prediction of Glucose Concentration" G P., *27th International Joint Conference on Artificial Intelligence (IJCAI 2018)*, KDH, July, Sweden, the 1st price in the glucose prediction challenge.
- J Luo, K Nikolic, B D Evans, N Dong, X Sun, P Andras, A Yakovlev, P Degenaar, "Optogenetics in Silicon: A Neural Processor for Predicting Optically Active Neural Networks", *IEEE Transactions on Biomedical Circuits and Systems*, vol. *11*, pp. 15–27, 2017
- J Rodriguez-Manzano, P Y Chia, T W Yeo, A Holmes, P Georgiou, S Yacoub, "Improving Dengue Diagnostics and Management Through Innovative Technology", *Current infectious disease reports*, *1;20(8):25*, 2018
- J Rodriguez-Manzano, A Moniri, K Malpartida-Cardenas, J Dronavalli, F Davies, A Holmes, P Georgiou, "Simultaneous single-channel multiplex and quantification of carbapenem-resistant genes using multidimensional standard curves", *bioRxiv*, p.409912, 2018
- J Zeng, N Miscourides, P Georgiou, "A 128×128 Current-Mode Ultra-High Frame Rate ISFET Array for Ion Imaging," *2018 IEEE International Symposium on Circuits and Systems (ISCAS)*, Florence, Italy, pp. 1–5, 2018

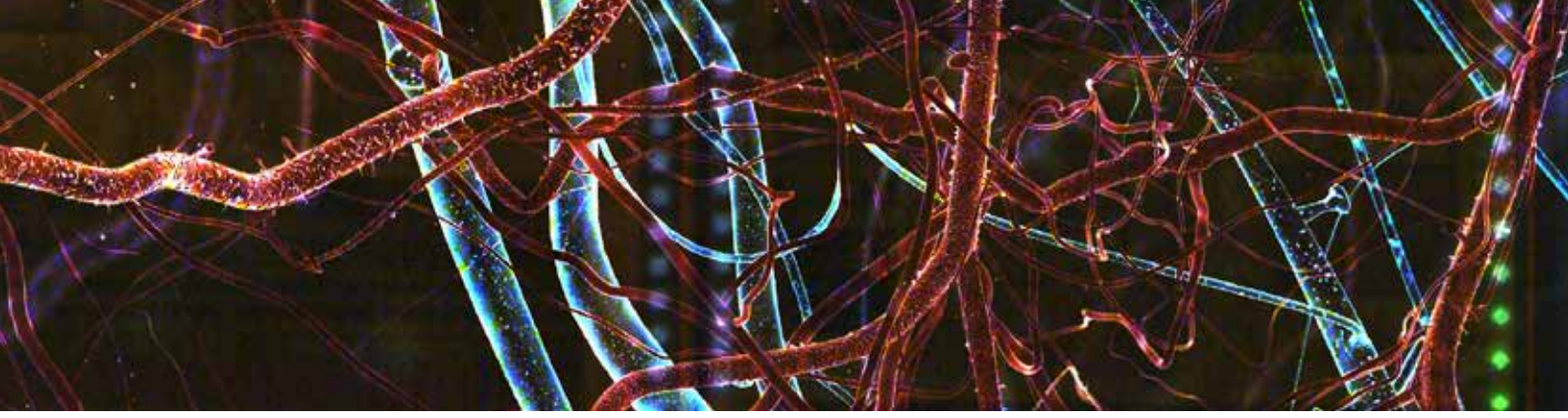

K A Dyar, D Lutter, A Artati, N J Ceglia, Y Liu, D Armenta, M Jastroch, S Schneider, S de Mateo, M Cervantes, S Abbondante, P Tognini, R Orozco-Solis, K Kinouchi, C Wang, R Swerdlhoff, S Nadeef, S Masri, P Magistretti, V Orlando, E Borrelli, N H Uhlenhaut, P Baldi, J Adamski, M H Tschöp, K Eckel-Mahan, P Sassone-Corsi, "Atlas of Circadian Metabolism Reveals System-wide Coordination and Communication between Clocks", *Cell*, vol. 174(6):1571–1585, 2018

K B Mirza, A Alenda, A Eftekhar, N Grossman, K Nikolic, S R Bloom, and C Toumazou. "Influence of Cholecystokinin-8 on Compound Nerve Action Potentials from Ventral Gastric Vagus in Rats," *International Journal of Neural Systems*, vol. 28, p.1850006 (17 pages), 2018.

K B Mirza, K Wildner, N Kulasekeram, S Cork, S Bloom, K Nikolic, C Toumazou, Live demo: Platform for closed loop neuromodulation based on dual mode biosignals, *2017 IEEE Symposium on Biomedical Circuits and System (BioCAS)*, Turin

K Elmantawi, N Miscourides, E Koutsos, P Georgiou, "A 96-channel ASIC for sEMG Fatigue Monitoring with Compressed Sensing for Data Reduction," *2018 IEEE International Symposium on Circuits and Systems (ISCAS)*, Florence, Italy, 2018, pp. 1–5

K Li, D John, L Chengyuan, P Herrero, P Georgiou, "Convolutional Recurrent Neural Networks for Glucose Prediction." *ArXiv:1807.03043 [Cs]*, July 9, 2018.

K Li, F Liu, H Dong, P Herrero, Y Guo, P Georgiou, "A Deep Learning Platform For Diabetes Big Data Analysis", *Diabetes Technology & Therapeutics* 20, A116–A116, 2018

K Malpartida-Cardenas, J Rodriguez-Manzano, LS Yu, M J Delves, C Nguon, K Chotivanich, J Baum, P Georgiou, "Allele-Specific Isothermal Amplification Method Using Unmodified Self-Stabilizing Competitive Primers," *Anal. Chem.*, vol. 90, no. 20, pp. 11972–11980, 2018

K Wildner, N Kulasekeram, K B Mirza, C Toumazou, and K Nikolic: "Live Demo: Reconfigurable Low-noise Multichannel Amplifier for Neurochemical Recording", in *Circuits and Systems (ISCAS)*, *2018 IEEE International Symposium on*, 1–1, 2018

L B Leene, M Maslik, P Feng, K M Szostak, F Mazza and T G Constandinou, "Autonomous SoC for Neural Local Field Potential Recording in mm-Scale Wireless Implants," *2018 IEEE International Symposium on Circuits and Systems (ISCAS)*, Florence, Italy, pp. 1–5, 2018

L B Leene, T G Constandinou, "A 0.006mm² 1.2uW Analog-to-Time Converter for Asynchronous Bio-Sensors," in *IEEE Journal of Solid-State Circuits*, vol. 53, no. 9, pp. 2604–2613, Sept. 2018

L Zou, M R Bahmanyar, C McLeod, "Thin Cavity-Backed Slot Antenna for Deeply Implantable Devices", *12th European Conference on Antennas and Propagation (EuCAP)*, 9–13 April, London 2018.

M Douthwaite, P Georgiou, "An Asynchronous Auto-biasing Circuit for Wearable Electrochemical Sensors", In *IEEE Biomedical Circuits and Systems Conference (BioCAS)* (pp. 1–4). Cleveland, OH, 2018

M Douthwaite, P Georgiou, (2017). Live Demonstration : "A Batteryless CMOS ISFET Array Powered by Body Heat for Real-Time Monitoring of Bio-fluids", In *IEEE Biomedical Circuits and Systems Conference (BioCAS)* (Vol. 16, p. 6514). Torino

M El-Sharkawy, J Daniels, P Pesl, M Reddy, N Oliver, P Herrero & P Georgiou, "A Portable Low-Power Platform for Ambulatory Closed Loop Control of Blood Glucose in Type 1 Diabetes" In *Circuits and Systems (ISCAS)*, *2018 IEEE International Symposium on* (pp. 1–5). IEEE, 2018

M Gantier, M Kalofonou, C Toumazou, "A trapped charge compensation scheme for ISFET based translinear circuits," *IEEE International Symposium on Circuits and Systems (ISCAS)*, 2018

M Maslik, Y Liu, T S B Lande, and T G Constandinou, "Continuous-Time Acquisition of Biosignals Using a Charge-Based ADC Topology," *IEEE Transactions on Biomedical Circuits and Systems*, vol. 12, no. 3, pp. 471–482, June 2018

M Maslik, T S B Lande, and T G Constandinou, "A Clockless Method of Flicker Noise Suppression in Continuous-Time Acquisition of Biosignals," in *2018 IEEE Biomedical Circuits and Systems Conference (BioCAS)*, Oct 2018, pp. 1–4

M H Abdulwahab, N Moser, J Rodriguez-Manzano, P Georgiou, "A CMOS Bio-Chip combining pH Sensing, Temperature Regulation and Electric Field Generation for DNA Detection and Manipulation", *2018 IEEE International Symposium on Circuits and Systems (ISCAS)*, Florence, Italy, pp. 1–5, 2018



N Ahmadi, T G Constandinou, C Bouganis, “Spike rate estimation using Bayesian Adaptive Kernel Smoother (BAKS) and its application to brain machine interfaces”, *Proc. EMBC*, 2018

N Kulasekeram, K Wildner, K B Mirza, K Nikolic, and C Toumazou: “Reconfigurable Low-noise Multichannel Amplifier for Neurochemical Recording”, in *Circuits and Systems (ISCAS)*, 2018 *IEEE International Symposium on*, 1–5

N Miscourides, L Yu, J Rodriguez-Manzano, P Georgiou, “A 12.8 k Current-Mode Velocity-Saturation ISFET Array for On-Chip Real-Time DNA Detection,” in *IEEE Transactions on Biomedical Circuits and Systems*, vol. 12, no. 5, pp. 1202–1214, Oct. 2018. doi: 10.1109/TBCAS.2018.2851448

N Moser, J Rodriguez-Manzano, T S Lande, P Georgiou, “A scalable ISFET sensing and memory array with sensor auto-calibration for on-chip real-time DNA detection”, *IEEE transactions on biomedical circuits and systems*, 12(2), pp.390–401, 2018

P Feng, T G Constandinou, “Robust Wireless Power Transfer to Multiple mm-Scale Freely-Positioned Neural Implants”, 2018 *IEEE Biomedical Circuits and Systems Conference (BioCAS)*, Cleveland, 2018, pp. 1–4

P Feng, P Yeon, Y Cheng, M Ghovanloo and T G Constandinou, “Chip-Scale Coils for Millimeter-Sized Bio-Implants,” in *IEEE Transactions on Biomedical Circuits and Systems*

R Ramezani, Y Liu, F Dekhoda, A Soltan, D Haci, H Zhao, D Firfilionis, A Hazra, M Cunningham, A Jackson, T G Constandinou, and P Degenaar. “On-Probe Neural Interface ASIC for Combined Electrical Recording and optogenetic Stimulation”. In: *IEEE Transactions on Biomedical Circuits and Systems* 12.3(2018), pp. 576–588

S C Cork, A Eftekhari, K B Mirza, C Zuliani, K Nikolic, J V Gardiner, S R Bloom, and C Toumazou, “Extracellular pH Monitoring for Use in Closed-Loop Vagus Nerve Stimulation.” *Journal of Neural Engineering* 15, no. 1, p.016001 (11p), 2018

S Jarvis, K Nikolic and S R Schultz: “Neuronal gain modulability is determined by dendritic morphology: a computational optogenetic study”, *PLoS Computational Biology* vol. 14, no. 3, p. e1006027 (21p), 2018

S Markar, T Wiggins, S Antonowicz, S Chin, A Romano, K Nikolic, B. Evans, D. Cunningham, M. Muchal, J. Lagergren and G. Hanna: “Non-Invasive Exhaled Breath Volatile Organic Compound Analysis for the Diagnosis of Oesophago-Gastric Cancer; Multi-Centre Validation Study”, *JAMA Oncology*, *JAMA Oncology*, doi:10.1001/jamaoncol.2018.0991 (7 pages + 31 pages Supplementary Material), 2018

S S Ghoreishizadeh, D Moschou, D McBay, C Gonzalez-Solino, G Dutta, M Di Lorenzo, A Soltan, “Towards self-powered and autonomous wearable glucose sensor” *IEEE International conference in electronics circuits and systems (ICECS)*, Bordeaux, France, December 2018

S S Ghoreishizadeh, X Zhang, S Sharma, P Georgiou, “Study of electrochemical impedance of a continuous glucose monitoring sensor and its correlation with sensor performance”, *IEEE Sensors Letters*, 2(1), pp.1–4, 2018

T Ahmed, K B Mirza, K Nikolic, “Resource Efficient Pre-processor for Drift Removal in Neurochemical signals”, in *Circuits and Systems (ISCAS)*, 2018 *IEEE International Symposium on*, 1–5

T Lanteslager, M Tømmer, T S Lande, T G Constandinou, 2018, “Cross-Body UWB Radar Sensing of Arterial Pulse Propagation and Ventricular Dynamics”, *IEEE Biomedical Circuits and Systems (BioCAS) Conference*, Publisher: IEEE

T Zhu, K Li, P Herrero, J Chen, “A Deep Learning Algorithm For Personalized Blood Glucose Prediction” G P. 27th International Joint Conference on Artificial Intelligence (IJCAI 2018) KDH, July, Sweden

W O Ting, S S Ghoreishizadeh, “Autonomous readout ASIC with 169dB input dynamic range for amperometric measurement”, *IEEE International conference in electronics circuits and systems (ICECS)*, Bordeaux, France, December 2018

X Fernandez-Cassi, N Timoneda, S Martínez-Puchol, M Rusiñol, J Rodriguez-Manzano, N Figuerola, S Bofill-Mas, J F Abril, R Girones, “Metagenomics for the study of viruses in urban sewage as a tool for public health surveillance”, *Science of The Total Environment*, 618, pp.870–880, 2018

Y Liu, J L Pereira, T G Constandinou, “Event-driven processing for hardware-efficient neural spike sorting”, *Journal of neural engineering*, 15.1, p. 016016, 2018.

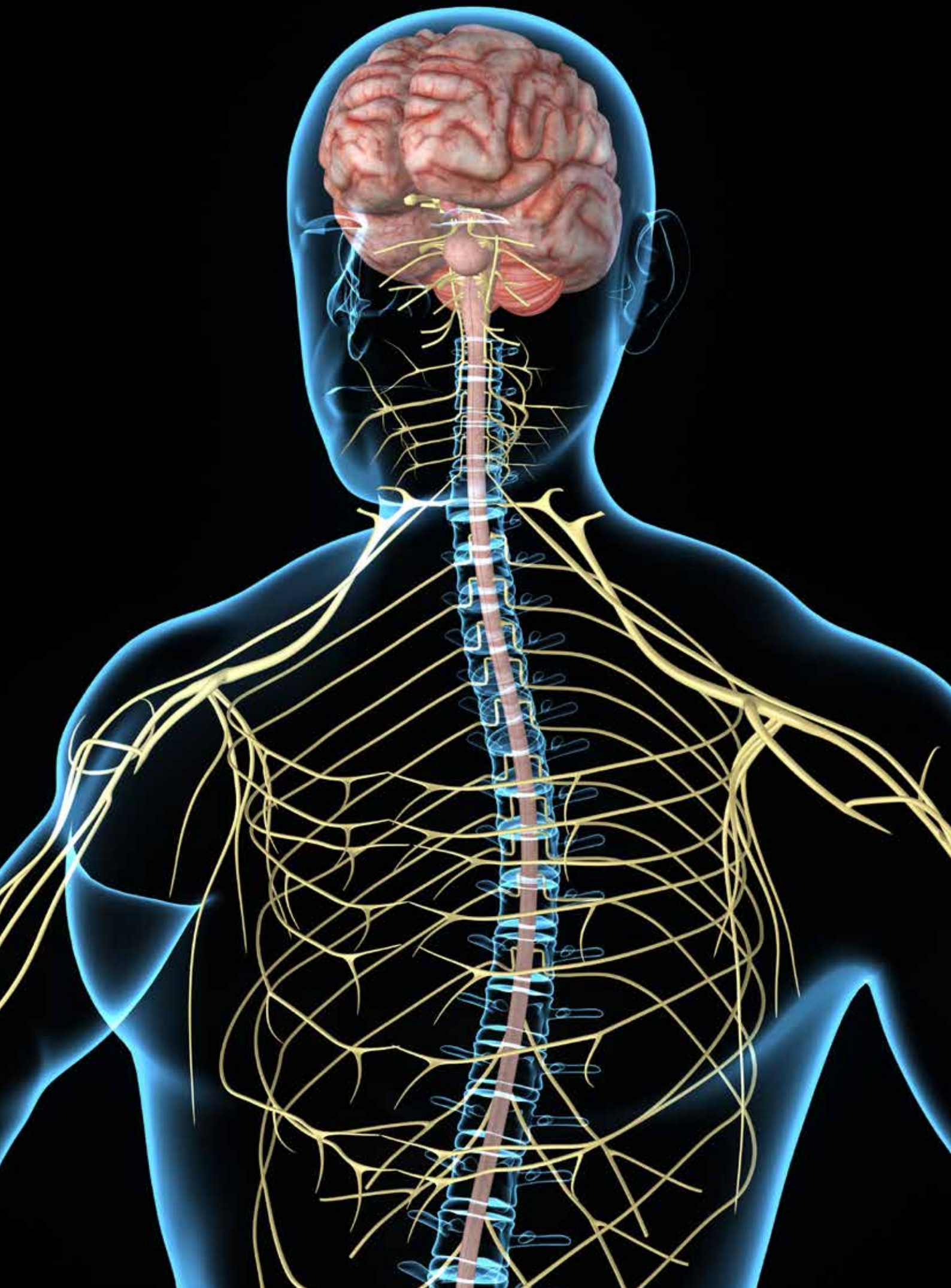



Imperial College London

Centre for Bio-Inspired Technology
Department of Electrical and
Electronic Engineering
Imperial College London
South Kensington
London SW7 2AZ

T +44 (0)20 7594 0701

F +44 (0)20 7594 0704

bioinspired@imperial.ac.uk

www.imperial.ac.uk/bioinspiredtechnology

 @ImperialCBIT

