

**Imperial College
London**

**Centre for
Bio-Inspired Technology**

Annual Report 2016

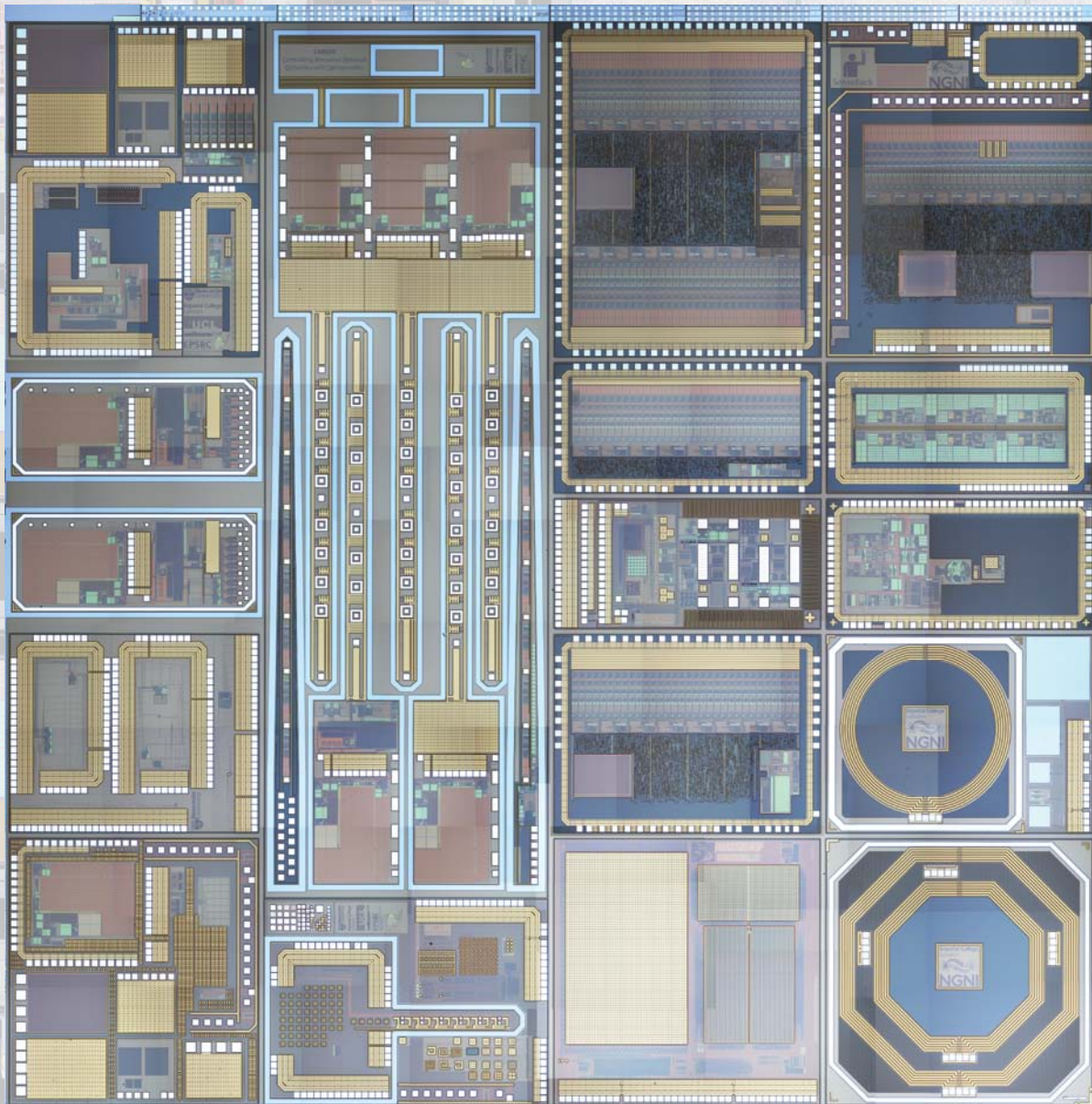



Centre for Bio-Inspired Technology
Institute of Biomedical Engineering
Imperial College London
South Kensington
London SW7 2AZ

T +44 (0)20 7594 0701

F +44 (0)20 7594 0704

bioinspired@imperial.ac.uk

Chip microphotograph (shown above) of 2016 CBIT reticle design in AMS 0.35 μ m 2P4M HV CMOS technology. Also front cover illustration shows full engineering wafer.

For further details see: 'Chip gallery' feature on page 23.

www.imperial.ac.uk/bioinspiredtechnology

Centre for Bio-Inspired Technology

Annual Report 2016

- 3 Director's foreword**
- 4 Founding Sponsor's foreword**
- 5 People**
- 7 News**
 - 7 Staff and events
 - 9 Spin-out companies
- 10 Reflections from alumni**
- 11 Research themes**
 - 12 Genetic technology
 - 13 Metabolic technology
 - 14 Neural interfaces & neuroprosthetics
 - 15 Cancer technology
- 16 Research funding**
- 17 Featured research**
 - 17 PEPPER: Patient Empowerment through Predictive PERsonalised decision support
 - 18 Enabling technologies for sensory feedback in next-generation assistive devices (SenseBack)
 - 19 Nudgeomics – A bio-inspired study of libertarian paternalism
 - 21 Engineering rapid and sensitive electronic diagnostics for infectious disease
- 23 Chip gallery**
- 27 Research facilities**
- 29 Who we are**
 - 30 Academic staff profiles
 - 35 Administrative staff profiles
 - 36 Staff research reports
 - 57 Research students' and assistants' reports

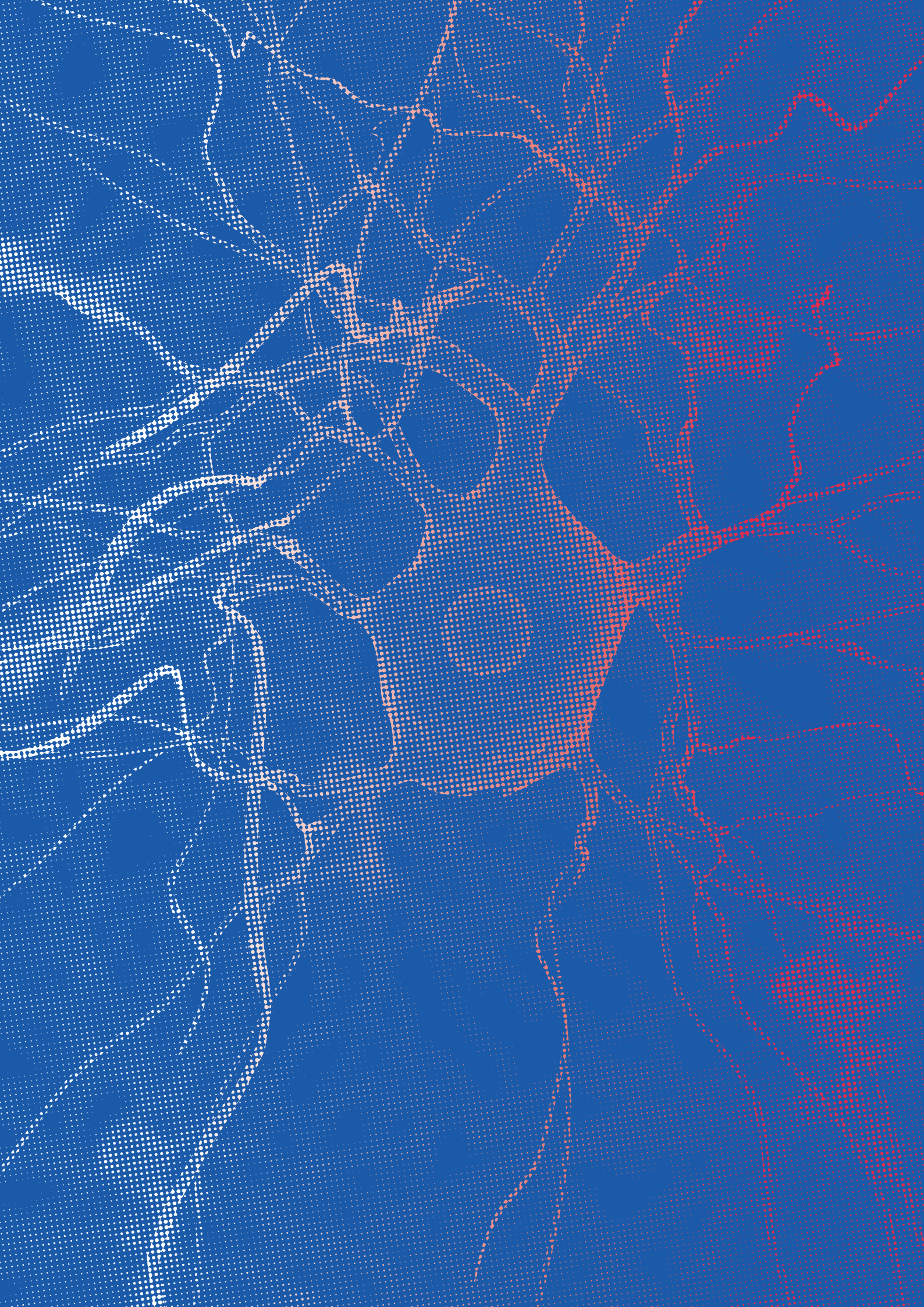

Director's foreword



The Centre for Bio-Inspired Technology is built upon the ingenuity and hard work of its members and it is my pleasure to report continued recognition of these efforts with another successful year of grants, promotions and awards. British research faces an important transition over the next few years, making it important not only to reflect upon the many successes within the Centre over the past year but also to reaffirm our commitment to our EU and international members who comprise more than 80% of our Centre.

Following from last year's funding awards, work has begun in earnest on combating Anti-Microbial Resistance (AMR) – one of the most pressing problems facing society today, estimated to cost the NHS £1bn annually. Not only have Dr Pantelis Georgiou and Dr Pau Herrero been funded by the *EPSRC EMBRACE* project to tackle this through academic research, but our spin-out company DNA electronics has won a grant for \$51.9m to detect such resistant microbes. It's particularly pleasing to witness the progression from the theory of academia to the application of industry to address such an important challenge.

Dr Georgiou was successful with another grant concerning microbes – the *EPSRC Global Challenges Research Award* – for developing technologies to

detect infectious disease such as Zika, Dengue and Malaria with collaborators in Vietnam, Thailand and Brazil. Clinical trials of the bio-inspired artificial pancreas were successfully completed with the project maturing to secure further funding for a three-month pivotal trial in the home environment. Meanwhile, a *Horizon 2020* award was granted to the same team for the *Pepper* project – a complimentary approach to improve decision making and therapy for people with Type I diabetes using smartphone and wearable technologies. Finally, Prof Chris McLeod secured an additional £2m from the *Health Innovation Challenge Fund* for testing up to the first-in-man trial of his wireless sensors for monitoring blood pressure.

This year also marks two big technological milestones. Continuing to apply ever more sophisticated tools to our biomedical challenges led to the fabrication of a chip with 65 nm technology for the first time in CBIT, enabled by the *Europractice Advanced Technology Stimulation Programme*. We're also fortunate to have such an abundance of chip designs that for the first time we commissioned an entire dedicated engineering wafer for fabrication. We expect to see plenty of late-nights as our designers turn testers for the winter months ahead!

It's particularly gratifying to see the group's output recognised for *quality* as well as *quantity*. We congratulate Dr Tim Constandinou for a particularly stellar year – gaining a promotion to Reader and the *President's Award for Research Supervision*. I am also humbled to receive the *President's Award for Innovation* – a great honour earned through the Centre's efforts. Last but by no means least, we also celebrate the success of our dedicated support staff, with CBIT's lynchpin, Iza Wojcicka-Grzesiak, being promoted to Senior Centre Administrator.

Whilst we celebrate these recent successes, we continue to strive for more. We're delighted to see six of our PhD students pass their vivas this year and welcome seven more into the fold. Once again, the Centre has attracted the brightest and best within Imperial's prestigious Centres for Doctoral Training. We are also pleased to be joined this year by one of the President's PhD scholars. Our commitment to teaching and training the young talent within Imperial lays the foundation for our future success.

Finally, the interdisciplinary work of the group attracts not just the next generation of leaders in science and engineering but also established academics from around the world. This year we welcome three eminent visiting scholars from Norway, Australia and the USA, forging new partnerships and strengthening existing ones. We look forward to another year as an international hub of collaboration and innovation.

Professor Chris Toumazou
FRS, FEng, FMedSci,
Regius Professor of Engineering

Founding Sponsor's foreword

It is now six years since the doors to the Centre for Bio-Inspired Technology opened, attracting some of the finest scientists and engineers in bio-medical technology from around the world. In that time, the Centre has grown into a leading international hub of multi-disciplinary research addressing some of the challenges for health in today's world.

In pursuit of these aims, it has been my pleasure to watch the investigators secure independent funds to continue their work and develop their research from the laboratory to the clinic. Knowledge transfer in this way has always been one of the core principles of the Centre. While translating research to medical application is a long and difficult process, it is fundamental to our fight against cancer, diabetes and sepsis to name just a few of the life-threatening conditions for which the Centre is actively developing therapies.

It is therefore especially gratifying to witness so many of these projects gain critical mass to have an impact in the medical and commercial worlds. The Centre has enjoyed success in many diverse fields in this way through publications, products and spin-out companies, with recent success in combating Anti-Microbial Resistance. It is through such products that engineering and academia directly benefit society.

The breakthrough work and recognised successes of the Centre bolsters its proven track record as it continues to spearhead new initiatives for tough and pressing problems. In turn, the reputation grows and attracts more talented researchers and more funding awards to begin new and ever more ambitious projects. As this circle completes, we look forward to it continuing to sustain itself through another successful six years at the heart of bio-medical innovation.

Professor Winston Wong BSc, DIC, PhD, DSc



People

Academic & senior research staff

Professor Chris Toumazou FRS, FEng, FMedSci

Regius Professor of Engineering;

Director, Centre for Bio-Inspired Technology;

Chief Scientist, Institute of Biomedical Engineering;

Winston Wong Chair in Biomedical Circuits,

Department of Electrical and Electronic Engineering

Dr Timothy G Constandinou

Reader, Department of Electrical and

Electronic Engineering;

Deputy Director, Centre for Bio-Inspired Technology

Dr Pantelis Georgiou

Senior Lecturer, Department of Electrical and

Electronic Engineering;

Head of Bio-Inspired Metabolic Technology Laboratory

Professor Chris N McLeod

Principal Research Fellow

Dr Konstantin Nikolic

Senior Research Fellow

Research staff

FELLOWS

Reza Bahmanyar, PhD

Nir Grossman, PhD

Pau Herrero Vinas, PhD

Nishanth Kulasekeram, PhD

Yan Liu, PhD

Yufei Liu, PhD

Nicoletta Nicolaou, PhD

Jesus Rodriguez Manzano, PhD

Nour Shublaq, DPhil

OFFICERS

Laszlo Grand, PhD

ASSOCIATES

Deren Barsakcioglu, PhD

Benjamin Evans, DPhil

Sara Ghoreishizadeh, PhD

Melpomeni Kalofonou, PhD

Sara de Mateo Lopez, PhD

Song Luan, PhD

Mohammadreza Sohbaty, PhD

Szostak, Katarzyna

Huan Wang, PhD

Ian Williams, PhD

Longfang Zou, PhD

Ling-Shan Yu, PhD

Assistants

John Daniels

Mohamed El-Sharkawy

Dorian Hacı

Bernard Hernandez

Lieuwe Leene

Khalid Mirza

Peter Pesl

Research students

Onur Guven

Ermis Koutsos

Timo Lauteslager

Dora Ma

Nicholaos Miscourides

Nicolas Moser

Adrien Rapeaux

Francesca Troiani

Peilong Feng

Michal Maslik (started October 2016)

Bryan Hsieh (started October 2016)

Federico Mazza

Ahmadi Nur

Chen Chih-Han (started November 2016)

Matthew Douthwaite

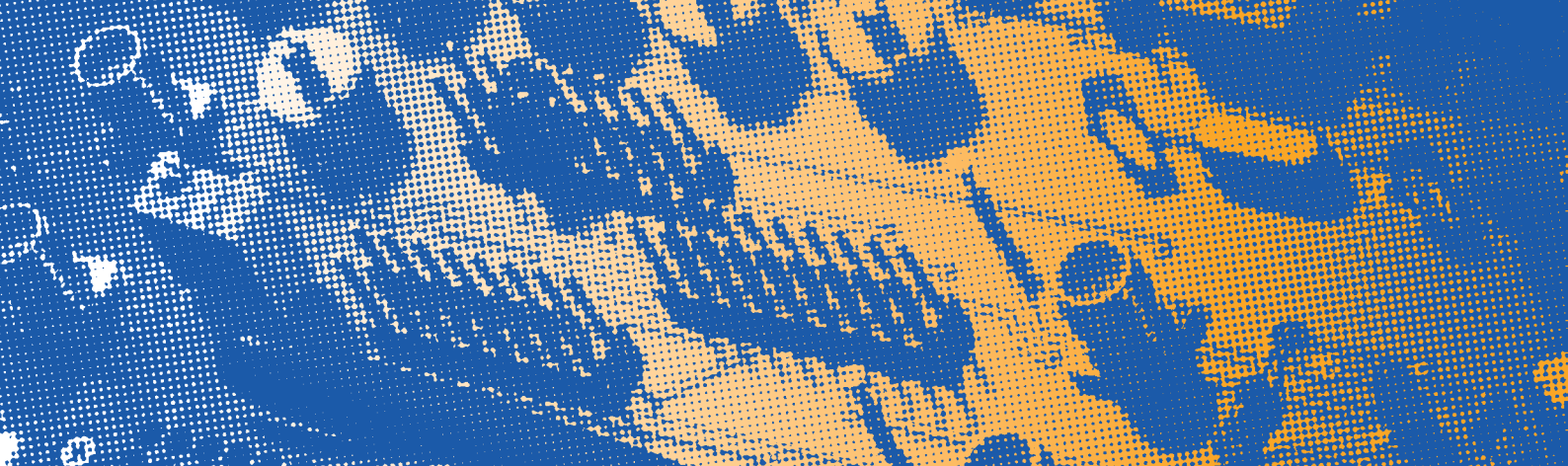

Xiaoran Liu (started November 2016)

Siwei Xie (started October 2016)

Administrative staff

Joao Reis

Project Administrator (part-time)

Wiesia Hsissen

Senior Group Administrator (CAS)

Gifty Kugblenu

PA to Professor Toumazou

Izabela Wojcicka-Grzesiak

Senior Research Centre Administrator (CBIT)

Consultants

Raymond Thompson

Rapid Prototyping Design Consultant

Visiting academics

PROFESSORS

Professor Alyssa Apsel

Cornell University

Professor Tor Sverre Lande

University of Oslo

Professor Andrew Mason

Michigan State University

Professor Bhusana Premanode

Professor David Skellern

Formerly Macquarie University, Australia

Professor Peter Wells FRS

Cardiff University

Professor Winston Wong

Grace THW, Taiwan

Professor Sir Magdi Yacoub FRS

National Heart & Lung Institute, Harefield Hospital

Professor Patrick Soon-Shiong

Chairman of the National Coalition of Health Integration (USA)

Researchers

Dr Alison Burdett

Toumaz Group, UK

Dr Jamil El-Imad

W Investments, UK

Dr Julio Georgiou

University of Cyprus

Dr Kiichi Niitsu

Nagoya University, Japan

Dr Miguel Silveira

Sensium Healthcare Ltd., UK

Dr Themis Prodromakis

University of Southampton

Graduates in 2015–2016

Deren Barsakcioglu

Research Associate, Centre for Bio-Inspired Technology

Lieuwe Leene

Research Assistant, Centre for Bio-Inspired Technology

Onur Guven

Peter Pesl

Research Associate, Centre for Bio-Inspired Technology

Stephen Woods

Head of Design, Duckworth & Kent Ltd

Researchers who have taken up appointments elsewhere

Andrea Alenda González

El Globo Muebles SL

Amir Eftekhari

National Center for Adaptive Neurotechnologies

Belinda Nedjai

Irina Spulber

Hamlyn Centre, Imperial College London

Claudio Zuliani

AMS Sensors UK Ltd

News

Staff and events

FEBRUARY 2016

Our latest clinical trial results on our advanced bolus calculator for diabetes (ABC4D) was presented by Dr. Monika Reddy at the Advanced Technologies and Therapeutics for Diabetes conference in Milan, Italy.



MARCH 2016

We successfully hosted our first EPSRC multidisciplinary conference to tackle Antimicrobial resistance as part of our EMBRACE, Bridging the gaps in Antimicrobial resistance initiative.

Various pump-priming awards and sandpits were also conducted under this initiative to kick-start new activities.



APRIL 2016

The Bio-inspired Artificial Pancreas was demonstrated at the Science Museum as part of the 'Antenna Live' 3-day Event held during the Easter half term at the beginning of April.

Around 1500 visitors came to see the artificial pancreas display at the Science Museum. Visitors were able to try out their new interactive meal library to test the effects of meals on Yoda and his pancreas.



MAY 2016

The ISCAS Conference held in Montreal, Canada in May 2016 was attended by Pantelis Georgiou, Timothy Constandinou, Dora Ma, Peter Pesl, Nicholas Miscourides, Melina Kalofonou, Ermis Koutsos, Sara Ghoreishizadeh, Nicolas Moser, Lieuwe Leene.

The Bio-inspired Artificial Pancreas won the best live demonstration award at this year's IEEE International Symposium on Circuits and Systems.



Brain Forum

On 26 and 27 May 2016, four members of the Centre for Bio-Inspired Technology travelled to Lausanne in Switzerland, to visit the Brainforum. This annual event aims to bring together researchers, industry, investors, policy makers and anyone interested in brain sciences. With the aim of raising the global profile of brain science and stimulating fresh thinking, experts from a range of different fields were invited to give lectures and participate in discussions. An excellent opportunity for us to learn about the state-of-the-art in neuroscience, and to network with others who work in this exciting field.



Awards

Professor Toumazou receives President's Medals for Excellence in Innovation and Entrepreneurship

The Award for Excellence in Innovation and Entrepreneurship celebrates the achievements of academics at Imperial, recognising unique activities breaking new frontiers, the effective and appropriate exploitation of research, and realised or prospective economic or social impact.

Dr Tim Constandinou receives President's Award for Excellence in Research Supervision

The award celebrates and acknowledges staff who are considered to have made an outstanding contribution towards a supportive environment.

JULY 2016

The Bio-inspired Artificial Pancreas is on the LifeWorks inspired by Nature Exhibition at the Cambridge Science Centre.



JULY 2016

Researchers from CBIT successfully took part in the first IEEE sensors summer school hosted by EPFL, Lausanne Switzerland.



JULY 2016

The sandpit event from EMBRACE was in 7–8 July 2016 and was attended by over 30 investigators from Imperial College and Universities of Newcastle, Surrey and Warwick gathered at South Kensington Campus. The winning team, led by Dr Andrew Edwards (MRC Centre for Molecular Bacteriology and Infection), was awarded £15K to develop an innovative solution to provide a novel target for a new type of therapeutic that promotes killing of bacteria by the immune system.



JULY 2016

FENS forum of Neuroscience attended by Timothy Constandinou, Nicoletta Nicolaou, Benjamin Evans, and Ian Williams.

SEPTEMBER 2016

Dr Timothy Constandinou promoted to Reader

The Deputy Director of the Centre has been promoted to Reader in the Department of Electrical and Electronic Engineering. Tim originally joined the department as an undergraduate student in 1988. After completing his PhD in 2005, he then moved to the Institute of Biomedical Engineering where he was appointed research officer for the bionics theme. In 2009, he became deputy director of the Centre for Bio-Inspired Technology and then re-joined the EEE Department as academic faculty in 2010, as a Lecturer in the Circuits & Systems Research group. He continues to maintain his role as deputy director of the Centre and also leads the research theme in Neural Interfaces and Neuroprosthetics.

OCTOBER 2016

Researchers from CBIT successfully presented their latest work at the IEEE Biomedical Circuits and Systems Conference 2016, Shanghai, China.

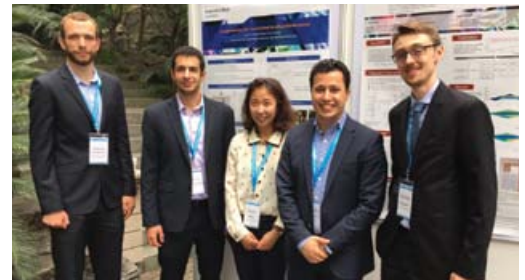

This was attended by Timothy Constandinou, Pantelis Georgiou, Dora Ma, Nicholas Miskourides, Nicolas Moser, Lieuwe Leene, Matthew Douthwaite, Zack Fehlick, Laszlo Grand, Timo Lauteslager (received Best Paper Award) and Konstantin Nikolic.

OCTOBER 2016

The 1st IEEE BrainCAS workshop that was co-chaired by Dr Timothy Constandinou followed the conference. BrainCAS was held from 20–21 October 2016 in Hangzhou, China.

This was a highly interactive, multi-disciplinary event that brought in experts from outside the CAS community (physiology, neuroscience, neurosurgery, material science) and featured 2-days of brainstorming and round table discussions. This was attended by the following members of CBIT: Adrien Rapeaux, Timo Lauteslager, Zach Fehlick, Laszlo Grand, Lieuwe Leene, Yan Liu, and Timothy Constandinou.



Members of CBIT at the 1st IEEE BrainCAS workshop together with close collaborators from Newcastle University and University of Southampton

News

Spin-out companies

SEPTEMBER 2016

DNA Electronics, the inventors of semiconductor-based next-generation DNA sequencing (NGS) technology and developers of a revolutionary blood-to-result test for bloodstream infections, has announced that the Biomedical Advanced Research and Development Authority (BARDA) a division of the Assistant Secretary for Preparedness and Response (ASPR) in the U.S. Department of Health and Human Services (HHS) has awarded the Company a contract worth up to \$51.9 million to develop its sequencing platform for rapid diagnosis in two key applications; antimicrobial resistant infections and influenza.

The Centers for Disease Control and Prevention (CDC) have estimated that more than 2 million people per year in the U.S. suffer antimicrobial resistant infections resulting in 23,000 deaths. The CDC also predicts that a flu pandemic could result in between 89,000 and 207,000 deaths in the U.S. and could cost the economy \$71.3-166.5 billion.

Genomic information derived from DNA sequencing is transforming many areas of medicine. This is the first NGS platform supported by BARDA, with game-changing potential in the diagnosis and treatment of infectious diseases.

The contract for the project entitled PISCES (Pathogen Identification from Specimen, via Capture Extraction and Sequencing) will enable DNAe to complete the development and validation of its ground-breaking Genalysis® platform and support a series of applications to the U.S. Food and Drug Administration for marketing clearance. The Genalysis® platform will combine the ability to sequence the DNA of the infectious organism, in a sealed microchip based system, direct from clinical specimen, with analysis that enables actionable identification of the disease agent within a few hours, a key requirement in the effective treatment of infectious diseases.

DNAe's first product will be a rapid blood-to-result diagnostic system to meet an unmet need in the treatment of serious bloodstream infections leading to sepsis. Sepsis is an area of very high unmet medical need, responsible for over 200,000 deaths per annum in the US, more than prostate cancer, breast cancer and AIDS combined. In late stage development and testing, the new system is set for commercial launch in 2018.

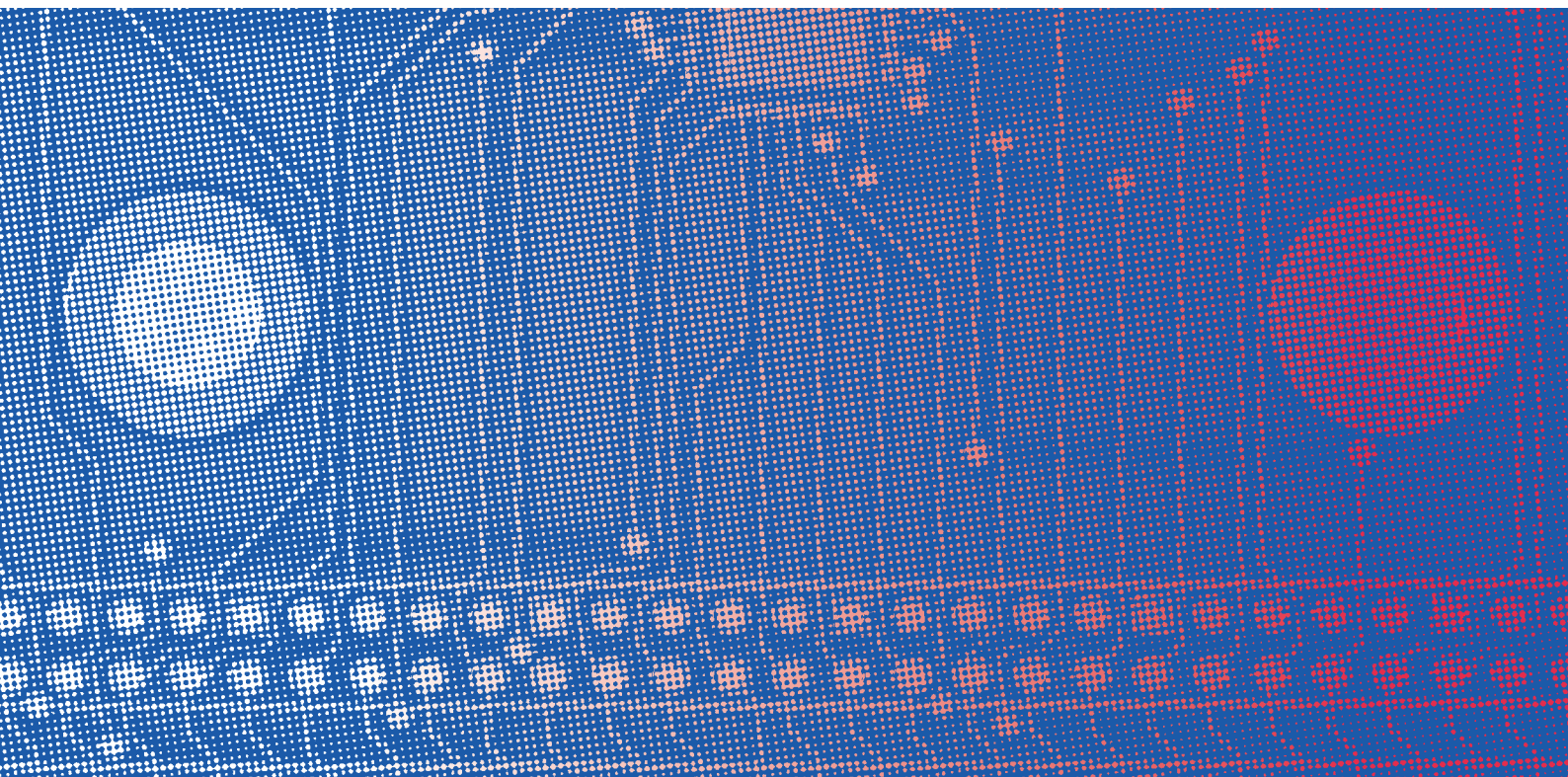

Reflections from Alumni



AMIR EFTEKFAR, PHD

**Research Fellow
2010–2016**

Imperial College was the home for my academic journey for the last several years. I completed my undergraduate studies in the Department of Electrical and Electronic Engineering and then my PhD and Post-doctoral years at the Centre for Bio-Inspired Technology (CBIT).

I worked in a multitude of areas; utilizing ground-breaking technology in high-impact healthcare applications such as Epilepsy, Brain Machine Interfacing and Obesity. This work combined CBIT's research, personnel, and commercial experience, bridging the gap between basic science and translation. From spin-outs to blue-sky research, both of which I was fortunate enough to participate in, CBIT demonstrates itself as a world-class institution.

I have now left to pursue new horizons in healthcare technology in the US at the National Center for Adaptive Neurotechnologies in New York, under Drs Jonathan Wolpaw and Gerwin Schalk. Here we are developing technology, based on 30 years of research, for spinal cord injury rehabilitation. The technology utilizes operant conditioning, wherein patients, with feedback, change their abnormal muscular reflexes over a few months, thus improving their walking and arm control. My role is to lead the engineering developments towards a distributable clinical system and then a commercial one.

The work has brought together all my experiences from Imperial College and CBIT, through Prof. Toumazou. There are many obstacles to overcome to pull these types of translatory projects together. Management, both technical, project and people-orientated, is a critical ingredient that I have picked up along the way, along with many technical skills. When combined with an innovative idea, sustainable financial support, and an expert multi-disciplinary team, such ideas can make it, if the market is ready. The success CBIT has demonstrated attests to their ability to mix these ingredients, I thank them for all that I have learnt and I wish them all the best for their future endeavors.



**LORENA GONÇALVES DE
ALCÂNTARA E FREITAS**

2015 visiting student

At the end of my MSc in Neuroscience, I had the unparalleled opportunity to work at the Centre for Bio-Inspired Technology (CBIT) for 5 months. During this time not only did I have the chance to hone skills I had previously developed, but I was also encouraged to develop new ones and get out of my comfort zone.

Throughout the process I had the support of brilliant colleagues from various scientific backgrounds and the invaluable guidance of my excellent supervisors, which made my time at the CBIT a highly stimulating experience and prepared me for my future career steps.

I was involved in the AnaeWARE project, which addressed the problem of intraoperative awareness. The project offered an innovative approach, based on multi-modal data, to study the effects of anaesthesia on the human body. The final goal was to create a closed-loop system for perioperative drug delivery to improve safety for patients and reduce physicians' workload. My role involved both data collection and analysis, which put me in the thrilling position of doing cutting-edge research from a highly interdisciplinary point of view. Working closely with both engineers and medical doctors in such a challenging environment while being surrounded by passionate colleagues both qualified and inspired me to develop my career in the direction I planned.

CBIT provides the perfect environment for every scientist to thrive, no matter at which point of their careers they join it. Its first-rate facilities and exceptional researchers are backed by a friendly and informal atmosphere, which makes casual discussions an extra source of knowledge and potential collaborations. The personal and professional skills I developed during that time paved the way to my securing a PhD position at the Engineering Department of another prestigious university - the École Polytechnique Fédérale de Lausanne (EPFL), in Switzerland.



Our mission: Inspired by lifestyle aspirations and biological systems, the Centre for Bio-Inspired Technology is inventing, developing and demonstrating devices to meet global challenges in engineering, science and healthcare, by effectively and efficiently mimicking living systems to create innovative and advanced technologies.

Research strategy

The Centre's research programme involves a strong combination of integrated miniature sensing with biologically-inspired, intelligent processing, through state-of-the-art semiconductor technology. We aim to make small healthcare devices, which combine electronics with biological processes. By applying conventional silicon microchip technology in new ways, we are creating new opportunities for medical device innovation.

We have pioneered next generation semiconductor sequencing (spun out and licensed internationally), developed and trialed the world's first bio-inspired artificial pancreas for Type I diabetes, invented and commercialized the disposable digital plaster for healthcare monitoring (now both FDA-approved and CE-marked), and are continuing to push the envelope of how semiconductor technology is applied to biomedicine.

Such advances mean that there can be a shift in care away from a centralized model that puts the physician at its core to a smarter, more decentralized approach centred on the patient – known as personalised healthcare. They also open up new ways of coping with the huge problems of ageing populations and surges in chronic ailments such as diabetes and heart disease.

In our Centre, building a solid foundation for technological innovation through workbench engineering and fundamental scientific research is integral to our approach. Advancements at this level are crucial, not only for the enhancement and application of existing technologies and materials, but also for the discovery of new and disruptive alternatives. Research efforts at the preclinical stage then filter through to positive clinical outcomes with an agility only possible from the integrated development process found in CBIT. Innovations also flow both ways with the development of our novel technologies equipping scientists and engineers with new tools to address research questions of fundamental importance.

Researchers within the Centre for Bio-Inspired Technology also work together with other scientists and engineers from across Imperial College as well as in collaboration with partner institutions and industry. Project teams include medical researchers and clinicians to ensure the focus remains on the medical needs we aim to address. The Centre's Research Strategy is based on applying engineering technologies in innovative ways to provide personalised healthcare devices for chronic disease management. Our key activities are organized into four application-aligned technology themes: Genetic, Metabolic, Neural and Cancer.



Genetic technology

Research focuses on the development of semiconductor based fully integrated Lab-on-Chip platforms for detection of genetic markers in applications ranging from rapid diagnostics to on-the-spot genetic testing.

www.imperial.ac.uk/bio-inspired-technology/research/genetic

HEAD OF RESEARCH

Professor Chris Toumazou FRS, FREng, FMedSci

Infection, Cancer, Kidney disease and infertility, are examples of medical conditions where prevention, control, early detection and continuous monitoring have become the primary goals for the creation of a more evidence-based disease management model of healthcare. The fast growing information gained from molecular and clinical research on the identification and mapping of major genetic and epigenetic targets has provided insight on their role in susceptibility of disease and has led to a deeper understanding of their diagnostic, predictive and prognostic significance.

Additionally, advances in diagnostic testing, genotyping, sequencing and the development of new technologies for Point-of-Care testing, are creating a paradigm-shift in modern medicine practices, ranging from the translation of technology innovations for emerging clinical applications towards the realisation of a more affordable and stratified clinical model.

Current methods for detection of genetic markers are mainly optical-based, are dependent on the use of fluorescent labels and of complex sample processing steps for isolation and discrimination of DNA sequences, therefore are difficult to scale. They are also mainly based on central laboratory facilities, with tests performed by skilled personnel and are of high cost. Given the needs for simplicity, low cost, speed, scalability and intelligence, genetic testing can now be simplified to lab-free, fast sample-to-result tests with the use of semiconductor technology, which allows for the integration of sensors, intelligent circuitry, signal processing and microfluidics, all in a single fully-integrated scalable platform.

Our group has demonstrated that semiconductor technology can enable label-free, non-optical, real-time simultaneous amplification and detection of genetic targets using chemically sensitive transistors, also known as ISFETs (Ion-Sensitive Field-Effect Transistors), silicon chip-based chemical sensors traditionally utilised for measuring changes in ionic concentrations in solutions. Our group's expertise of over a decade in design and fabrication of robust chemical sensor arrays combined with microelectronics in CMOS integrating analog/digital circuitry, has resulted in numerous Lab-on-Chip platforms developed. Specifically in the area of diagnostics and disease prevention, where the emergence of smart sensory systems is evident, the

capability for these integrated platforms to perform intelligent sensing and actuation would improve significantly the speed for decision making at the point of need, delivering fast and on-the-spot results for detection of any target nucleic acid sequences in either DNA or RNA as well as nucleotide insertions. This technology has been successfully commercialized through one of our spinout companies, DNA Electronics, to create next generation technology for on-chip sequencing and sample analysis.

Applications in the Centre are ranging from fast genetic analysis of infectious targets (bacteria/ viruses) for rapid and controlled deployment of antibiotics and prevention of antimicrobial resistance – Infection Technology, to early screening of cancer markers and monitoring of progression targeting the personalisation of cancer treatment – Cancer Technology.

Furthering the application of genetic technology in medicine, our research also focuses on the role of epigenetic markers and specifically the role of DNA methylation in prediction and monitoring of disease. DNA methylation is a widely applied epigenetic biomarker, a chemical tag that can modify the genetic function and regulatory mechanisms of gene expression. It has been extensively applied in the field of cancer with previous work at the Centre to have led in the development of an ISFET based pH-mediated Lab-on-Chip platform for detection of DNA methylation ratio in well-studied cancer markers.

The same technology is also applied in chronic kidney disease (CKD) management, a condition resulting from chronic kidney damage and prolonged renal dysfunction, often leading to renal replacement therapy. Focusing on methods for microRNA quantification and DNA methylation detection, we are developing a detection system that could aid developments in related epigenetic therapy for typically irreversible kidney damage, preventing the need for dialysis and renal transplantation.

The ISFET based technology is also being applied in a new field in the group, that of reproductive medicine and specifically of infertility, aiming for the development of a novel diagnostic sample-to-result test for detection of human male infertility acting as a prognostic tool for any Assisted Reproductive Technology (ART) laboratory, based on the analysis of DNA methylation marks in human sperm samples through the use of isothermal nucleic acid chemistries.

Metabolic technology

Research is developing technologies for application in early detection, diagnosis and therapy of metabolic disease with the main focus on treating diabetes and its complications

www.imperial.ac.uk/bio-inspired-technology/research/metabolic

HEAD OF RESEARCH

Dr Pantelis Georgiou

Recent trends in daily lifestyle and poor diet have led to an increase in metabolic disorders which are affecting millions of people worldwide. A metabolic disorder develops when organs responsible for regulating metabolism fail to carry out their operation. Diabetes mellitus, currently the most severe metabolic disease and the leading cause of mortality and morbidity in the developed world, is caused by an absolute, or relative, lack of the hormone insulin which is responsible for homeostasis of glucose concentrations. Insulin deficiency leads to elevated glucose concentrations which, in turn, cause organ damage including retinopathy leading to blindness, nephropathy leading to kidney failure and neuropathy which is irreversible nerve damage. At least 3% of the world's population today is diagnosed with diabetes and this number is doubling every 15 years.

CURRENT RESEARCH INCLUDES:

The bio-inspired artificial pancreas – a fully closed loop system, which mimics the functionality of a healthy pancreas. The core of the system contains a silicon integrated circuit, which behaves in the same way as biological alpha and beta cells of the pancreas. In doing so, it aims to offer more physiological control to subjects with type 1 diabetes, using insulin to control hyperglycaemic events and glucagon to prevent hypoglycaemia.

We are pleased to announce that to date we have successfully validated the bio-inspired artificial pancreas in adult participants with type 1 diabetes acquiring over 1000 hours of clinical data with the system, and proving its safety and efficacy. Clinical trials were conducted at the NIHR/Wellcome Trust Imperial Clinical Research Facility, Hammersmith Hospital. Studies conducted so far include a 6-hour fasting closed-loop (CL) study (n=20), 13-hour overnight/post breakfast closed-loop study (n=17), 24-hour Randomised controlled crossover study (n=12), 24-hour CL study without meal announcement (n=8) and a 6-hour bi-hormonal study (n=6).

We are delighted to report that our results to date have proven the safety and efficacy of the Bio-inspired Artificial Pancreas and we are now moving forwards to conduct 3 month ambulatory trials on type 1 diabetic subjects in their home environment which will commence in January 2017.

Diabetes management systems – an integrated system of wireless sensors (glucose, heart rate and motion), decision support systems and smart-phones to create a telemedicine platform capable of continually monitoring, recording vital parameters and providing advice on insulin dosing which is required for treatment of diabetes. Additionally, the smart-phone provides a constant link to a clinician's database to allow constant monitoring from the hospital.

We have developed a smart-phone based Advanced Bolus Calculator for Diabetes (ABC4D), which is currently undergoing clinical trials in people with Type 1 diabetes and results to date are promising. In a six-week pilot study (n=10), we have demonstrated proof of concept, safety, and feasibility of ABC4D. We are pleased to announce that results showed improved glucose control with a reduction in hypoglycaemia and increased time in target range. We have also assessed device satisfaction which showed 90% of the population were happy to use the ABC4D system. The clinical efficacy of ABC4D is currently being tested in a large-scale randomised controlled study in people with Type 1 diabetes.

Sensory systems for continuous monitoring of metabolites – which includes devices which fully integrate chemical sensors and low power processing algorithms to provide cheap, disposable and intelligent chemical monitoring systems with long battery lifetimes. These are currently being used to make reliable and robust continuous glucose sensors by integrating glucose sensing micro-spikes with CMOS technology, making the sensor more robust, intelligent and adaptive. These will be expanded to sense other metabolites as well relevant to diabetes management.

Lab-on-chip diagnostics for diabetes – which includes devices that fully integrate a number of electrochemical sensors in CMOS to provide cheap and disposable diagnostics, which can be used at the point of need. These are diagnostic systems for potential genetic screening of type 1 and type 2 diabetes and their associated variants and complications such as MODY (Maturity Onset Diabetes of the Young).

Metabolic algorithms and models – which includes developing in silico models describing the interaction between glucose, insulin, glucagon and other metabolites within the body to allow reliable simulation and validation of algorithms used for diabetes management. We also develop fault detection systems to account for glucose sensor and insulin pump failures and variability within our closed loop system.

Neural interfaces and neuroprosthetics

Improvements in medical care and quality of life for individuals with neurological conditions such as epilepsy, spinal cord injury, paralysis and sensory impairment by developing implantable or wearable assistive technologies

www.imperial.ac.uk/bio-inspired-technology/research/neural-interfaces

HEAD OF RESEARCH

Dr Timothy Constandinou

We are now entering a tremendously exciting phase in our quest to understand the human brain. With large-scale programmes like the US Presidential BRAIN Initiative and the EU Human Brain Project, there is currently a huge appetite for new neurotechnologies and applications. We have already witnessed the impact made by devices such as cochlear implants and deep brain stimulators, with hundreds of thousands of individuals that have and are benefitting every day. Soon, similar assistive technology will emerge for the blind, those suffering from epilepsy, and many others.

With the current capability in microtechnology, never before have there been so many opportunities to develop devices that effectively interface with the nervous system. Such devices are often referred to as neural interfaces or brain-machine interfaces and range from wearable surface-electrode systems to fully implantable devices. The interface typically uses an electrical connection (i.e. electrodes) to achieve the neural recording and/or stimulation utilising a variety of techniques, including: electroencephalography (EEG), electromyography (EMG), electrocorticography (ECoG) and direct interfacing using penetrating intracortical electrodes. Neural prostheses use such interfaces to bypass dysfunctional pathways in the nervous system, by applying electronics to replace lost function. Our research at the Centre for Bio-Inspired Technology is aimed, ultimately at developing such devices to provide neural rehabilitation by exploiting the integration capability and scalability of modern semiconductor technology.

ONGOING RESEARCH

CANDO (Controlling Abnormal Network Dynamics using Optogenetics) – A world-class, multi-site, cross-disciplinary project to develop a cortical implant for optogenetic neural control. Over seven years the project will progress through several phases. Initial phases focus on technology design and development, followed by rigorous testing of performance and safety. The aim is to create a first-in-human-trial in the seventh year in patients with focal epilepsy.
www.cando.ac.uk

ENGINI (Empowering Next Generation Implantable Neural Interfaces) – Neural interfaces will in the future need to observe the activity of many thousands of

neurons. This will improve the effectiveness of neural decoding strategies by increasing the underlying information transfer rate. The availability of such a technology would be a true game changer, enabling new scientific and prosthetic applications. Our vision is that to achieve this, neural interfaces need to be distributed across multiple devices, each being autonomous and fully wireless. ENGINI is developing a new breed of mm-scale neural microsystems that directly tackle the grand challenges of long term stability, energy efficiency, and scalability.

www.imperial.ac.uk/neural-interfaces/research/projects/engini/

I2MOVE (Intelligent implantable modulator of Vagus nerve function for treatment of obesity) – The I2MOVE project is about tackling obesity. In this project, we are designing a bio-inspired implant that will serve as a novel treatment for obesity. The aim is to target the vagus nerve which transmits information between the gut and the brain. By stimulating the vagus nerve with electrical impulses, the implant will mimic the natural satiety signals produced after a meal, providing the patient with a means of appetite control.

www.imperial.ac.uk/a-z-research/i2move/

IPROBE (in-vivo Platform for the Real-time Observation of Brain Extracellular activity) – We are developing a methodology to record simultaneously from thousands of neurons spread over multiple structures of the living brain, and deliver a next generation neural recording platform to the international scientific community. This platform will exceed the current state-of-the-art by over an order of magnitude, providing a completely unprecedented understanding of how huge networks of individual neurons interact in time and space to support brain functions.

www.imperial.ac.uk/neural-interfaces/research/projects/iprobe/

SenseBack (Enabling Technologies for Sensory Feedback in Next-Generation Assistive Devices) – The goal of this project is to develop technologies that will enable the next generation of assistive devices to provide truly natural control through enhanced sensory feedback. To enable this level of feedback, we must meet two clear objectives: to generate artificial signals that mimic those of the natural arm and hand, and to provide a means of delivering those signals to the nervous system of a prosthesis user.

www.senseback.com

Cancer technology

Development of cancer diagnostic sample-to-result microchip based prototypes that will assist in risk stratification and optimization of cancer treatment at the early and advanced diagnostic stage

www.imperial.ac.uk/bio-inspired-technology/research/cancer-technology

HEAD OF RESEARCH

Professor Christofer Toumazou

Our research at the Centre for Bio-Inspired Technology is focused on the application of microchip based sensing technologies for early screening, detection and monitoring of cancer markers, with the ultimate goal being the development of systems assisting at the point of need aiming for the personalization of cancer therapy. Primary focus is on the areas of:

Breath analysis for oesophago-gastric cancer detection – Only 35% of patients with oesophago-gastric cancer are currently treated with curative intent, whereas 15% of those operable patients have Stage I cancer. The five-year survival for oesophageal and gastric cancer is 13% and 18% respectively in the UK, among the worst in Europe, demonstrating the clinical consequences of this diagnostic challenge. Our ultimate goal is to develop a hand-held, Point-of-Care device that can detect and analyse Volatile Organic Components (VOCs) in breath, to evaluate the risk of oesophago-gastric cancer and suggest the need for further endoscopic investigation.

This project is part of an ongoing collaboration with Prof George Hanna from St Mary's Hospital and his group, world leading experts in breathomics for oesophago-gastric cancer. A series of studies have already been conducted, which have identified statistically significant differences in the concentration of twelve VOCs from three chemical groups (aldehydes, fatty acids and phenols) from the exhaled breath of patients with oesophago-gastric cancer compared to a control group. Our research in the Centre for Bio-Inspired Technology involves the development of a prototype for VOC breath profiling, providing thus information necessary to determine and quantify the risk of oesophago-gastric cancer. Final diagnostic recommendation will be determined using an information theory based machine learning algorithm developed in our group by Dr Nikolic and his research team, which has been successfully implemented on other biological problems, e.g. identification of receptive field vectors (RFVs) for retinal ganglion cell types.

Early detection and therapeutic monitoring of breast cancer – In the UK, the majority of patients with breast cancer have no evidence of metastases at the time of diagnosis. Although surgery is capable of removing the primary cancer, in many patients, cancer cells can seed throughout the body forming micrometastases, not detectable through screening tests. These often persist despite medical treatment given after surgery and can grow and spread over time if left unchecked. Detecting early the presence of micrometastases before relapse occurs is of great importance as it will allow treatment to be tailored to the patients' clinical profile.

To date, a number of lab-based tests have been developed, primarily for diagnostic purposes, requiring tissue biopsies which are often difficult to obtain and may not be fully representative of the disease due to its inherent intratumoral heterogeneity, or are focusing on NGS methods, which are of high cost and require processing power to analyse genome-wide sequencing data. In contrast, a blood based test or 'liquid biopsy' has the potential to detect tumour specific genetic markers found in blood circulation, in a minimally invasive way. Such test could predict the risk of relapse and could be repeated over the course of treatment to monitor drug response and disease progression. This would enable the realization of a more 'curative', well-stratified, patient-centric therapy model.

This project is in collaboration with Prof Charles Coombes (Department of Surgery and Cancer, Imperial College London) and Prof Jacqui Shaw (Department of Cancer Studies, University of Leicester) whose research has shown that tumour specific mutations in circulating free DNA (cfDNA) found in blood plasma, can be used as biomarkers for detection and monitoring of breast cancer progression (from first diagnosis to follow-up), with the potential to differentiate between the period of cancer dormancy and of minimal residual disease. On the basis of this clinically validated work, our research in the Centre involves the development of a microchip-based, sample-to-result, scalable Lab-on-Chip system consisting of arrays of ISFET sensors, which in combination with microelectronics and information processing units will provide a fast and of low-cost solution for early detection of recurrence through precision screening and therapeutic monitoring of the disease.

Research funding

We are grateful to receive funding from government, the EU, charities, donors and industry. Our current portfolio includes the following:

Project	Sponsor	Start Date	Duration
GCRF	EPSRC	June 2016	10 months
PEPPER	Commission of the European Communities (EU)	February 2016	3 years
EMBRACE	EPSRC	August 2015	2 years
Enabling technologies for sensory feedback in next-generation assistive devices	EPSRC	March 2015	3 years
Implantable Empowering Next Generation Neural Interfaces	EPSRC	August 2015	5 years
i4i EPOC IMPACT	National Institute for Health Research	August 2015	3 years
Disruptive Semiconductor Technologies for Advanced Healthcare System	EPSRC	August 2015	5 years
Controlling Abnormal Network Dynamics with Optogenetics (CANDO)	Wellcome Trust / EPSRC	August 2014	7 years
“AnaWare” Monitoring awareness during anaesthesia	Commission of the European Communities (EU)	August 2014	2 years
Real-Time Neural Chemical Sensing in the Peripheral Nervous System	EPSRC	July 2013	3 years
An Intelligent and Implantable Modulator of Vagus Nerve Function Treatment of Obesity	Commission of the European Communities (EU)	April 2013	5 years
iPROBE: in-vivo Platform for the Real-time Observation of Brain Extracellular Activity	EPSRC	September 2013	3 years
A Bio-Inspired Artificial Pancreas for Control of Type 1 Diabetes in the Home	Wellcome Trust	August 2013	4 years
Automated BP monitoring	Wellcome Trust	September 2011	8 years

PEPPER: Patient Empowerment through Predictive PERSONALISED decision support

Research Team: Dr Pau Herrero, Dr Peter Pesl, Dr Monika Reddy, Dr Nick Oliver, Professor Des Johnston, Professor Chris Toumazou and Dr Pantelis Georgiou

Diabetes mellitus is a chronic disease that occurs either when the pancreas can no longer produce insulin (Type 1), or when the body cannot process the insulin it does produce (Type 2). The resulting deficiency of insulin leaves the body unable to control its blood glucose levels, which causes hyperglycaemia (high blood glucose).

Current regimens for treating Type 1 diabetes are based on subcutaneous injections of insulin administered several times a day. Insulin treatment is also frequently required in the disease progression of Type 2 diabetes. Large intervention trials performed in the EU and US showed how tight glycaemic control avoiding hyperglycaemia could prevent long term complications. In practice, however, people with diabetes can struggle to calculate the correct insulin dose because of the effect of so many dynamic factors that are not always easy to estimate and correlate (e.g. glucose dynamics, hormone levels, physical exercise, food). The task is so difficult that the percentage of individuals achieving the target in many EU countries is as low as 25%.

PEPPER is a EU-funded project (H2020) aiming to develop a personalised decision support system for diabetes management that will make predictions based on real-time data in order to empower individuals to participate in the self-management of their disease.

The design will involve users at every stage to ensure that the system meets patient needs and raises clinical outcomes by preventing adverse episodes and improving lifestyle, monitoring and quality of life. Research will be conducted into the development of an innovative adaptive decision support system based on case-based reasoning combined with predictive computer modelling. The tool will offer bespoke advice for self-management by integrating personal health systems with broad and various sources of physiological, lifestyle, environmental and social data. The research will also examine the extent to which human behavioural factors and usability issues have previously hindered the wider adoption of personal guidance systems for chronic disease self-management. It will be developed and validated initially for people with diabetes on basal-bolus insulin therapy, but the underlying approach can be adapted to other chronic diseases.

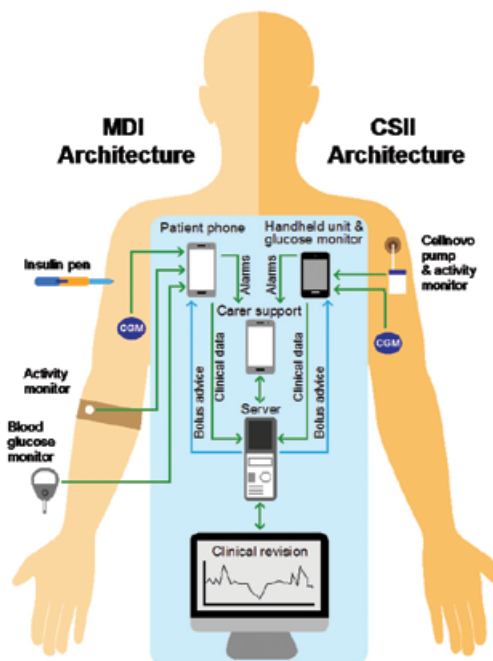

There will be a strong emphasis on safety, with glucose predictions, dose advice, alarms, limits and uncertainties communicated clearly to raise individual awareness of the risk of adverse events such as hypoglycaemia or hyperglycaemia. The outputs of this research will be validated in an ambulatory setting and a key aspect will be innovation management. All components will adhere to medical device standards in order to meet regulatory requirements and ensure interoperability, both with existing personal health systems and commercial products. The resulting architecture will improve interactions with healthcare professionals and provide a generic framework for providing adaptive mobile decision support, with innovation capacity to be thereby increasing the impact of the project.

For more information see www.pepper.eu.com



Enabling technologies for sensory feedback in next-generation assistive devices (SenseBack)

Dr Ian Williams, Adrien Rapeaux, Dr Tim Constandinou

Funding: EPSRC SenseBack (EP/M025977/1), in partnership with the Universities of Newcastle, Southampton, Keele, Essex and Leeds.

BACKGROUND

Great strides have been made in the capabilities of upper limb prosthetics over the last decade but they still provide almost no feedback to the user – this makes them difficult to control without visual monitoring and conceptually they remain something strapped to the user’s stump rather than a real replacement arm.

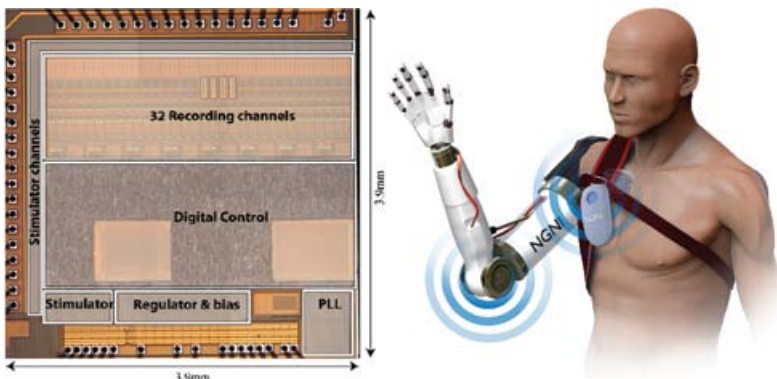

Microphotograph of the custom ASIC

PROJECT CONCEPT

The goal of this project is to develop technologies that will enable the next generation of assistive devices to provide truly natural control through enhanced sensory feedback. To enable this level of feedback, we must meet two clear objectives: to generate artificial signals that mimic those of the natural arm and hand, and to provide a means of delivering those signals to the nervous system of a prosthesis user.

To deliver technology addressing these objectives we are collaborating with universities around the UK and developing implantable silicon probes & electronics, novel tactile sensors and biomechanical models; with key aspects of the technology validated in chronic in-vivo testing in a rat model.

PROGRESS TO DATE

An experimental PCB neural interface has been designed to test stimulation and recording in the rat sciatic nerve model. It provided a base for the architecture of the implantable ASIC designed and manufactured this year. The ASIC is undergoing electrical testing before integration into an implantable PCB platform that will perform stimulation and recording in the rat for three months. Our collaborators have developed prototype silicon based electrodes and biomechanical models, as well as conducting acute in-vivo experiments.

The final system implanted in a rat will be composed of these novel electrodes (developed by Leeds University), the implantable ASIC, and a separate power-data communication implant connected to a wearable backpack hub for telemetry to external devices.

Our collaborators at Newcastle University have been able to demonstrate a relationship between the angle of flexion of rat leg and neural signal output. Replicating these signals and delivering them to the rat sciatic nerve will be a significant next step in the project.

THE FUTURE

What next? Over the next year we will complete the testing and development of the electronics and develop the wireless backpack. We will then move into testing of the implant encapsulation before handover of the devices to Newcastle University for the final acute in-vivo and full chronic in-vivo trials.

Our long-term goal is to create a bidirectional bridge between the nervous system and the prosthetic hand to enhance prosthetic function and we are looking at options to build on the technology developed in Senseback such as moving to optogenetic stimulation of peripheral nerves – an exciting field with some major challenges!

A) Raw ENG signal recorded during flexion of the foot in an in-vivo rat model. Stimulus begins at B markers and ceases at C markers.

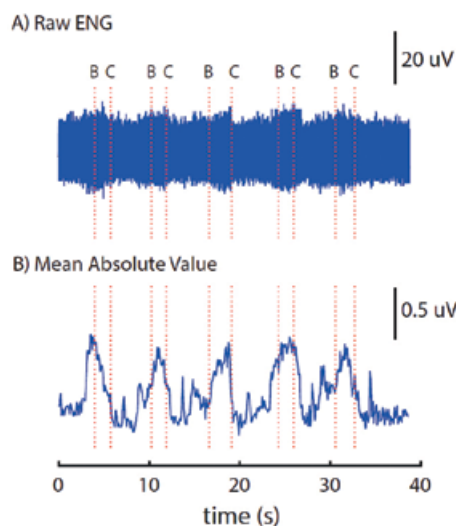

B) Mean Absolute value of the signal for the recording, showing the difference in intensity more clearly.

Project concept showing the three implanted devices:

- 1: power-data communication device.
- 2: Implantable stimulation and recording ASIC.
- 3: Silicon electrode array

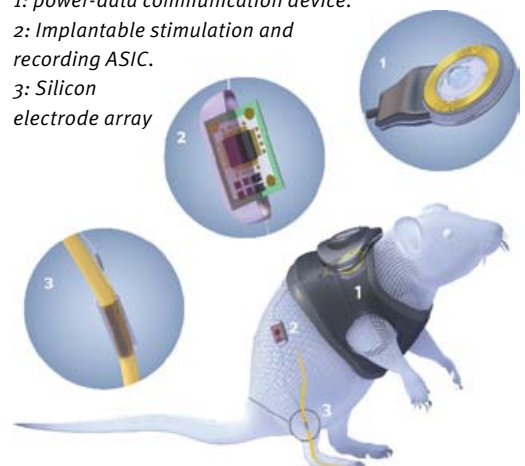

Nudgeomics – A bio-inspired study of libertarian paternalism

Professor Chris Toumazou and Dr Mohammadreza Sohbat

The world is facing a huge pandemic of obesity and related conditions, such as diabetes, and cardiovascular diseases, which are endangering lives and straining healthcare systems across the world. By 2020 it is predicted that more than 50 percent of the UK population will be obese, a trend projected to get even worse in the future.

Cancer, anti-microbial resistance, Alzheimer and dementia, etc are other growing challenges affecting people's lifestyle. Science and technology have been striving to understand and tackle these problems. On this journey, several trends have been introduced, from diagnosis to point-of-care and live monitoring, to closed-loop therapy, preventative medicine, and prediction and management. The recent news is that one solution does not fit all. 'Personalisation' is perceived to be the way forward.

On one hand the commercialisation of genetics in the form of direct-to-consumer genetic services is providing personalised DNA-based diets, exercises, supplements, and even cosmetics, to improve lifestyle and wellbeing. On the other hand, computer science and neuroscience have been uncovering broader layers of understanding human behaviour on the bed of biology. From the human genome project and the brain map initiative to the spread of artificial intelligence, our modern lifestyle is being constantly redefined. The Internet of Things, CRISPR (Gene Editing), Big Data, Synthetic Biology, Cloud Computing, Stem Cells, Smart Cities, ... each considered as 'the next big thing', are emerging and often intersecting, to change the way we think and interact with the world.

What has been achieved is incredible. The amount of data being processed is incredibly huge. It is all reaffirming how extensive the number of influential variables and dimensions in our ecosystem is. The information gathered does not necessarily show a direct map of cause to effect, rather the probability and uncertainty of all we have learned. Perhaps evolution can show a better solution which may be analogue to the way we behave and change. Maybe the enormous diversity out there, is not from a humongous number of variables, but an exponential replication (recursive combination) of limited parameters. All this diversity from the big bang has had billions of years of time to expand. One way to understand the cause to this variety is to look at the minor differences that generate new waves/traits.

SNP

Genetics has shown us we are not much different from a banana (70% similar). We as humans are 99.9% the same – less than 0.1% different. This level of distinction comes from single letter variations in our genetic codes. They are called SNPs (single nucleotide polymorphisms). These tiny dissimilarities make us fast or slow metaboliser of caffeine, pre-disposed to diabetes, a potentially endurance or sprint athlete, etc. Moreover, we are learning that we may encode and pass our newly developed habits to our children through such tiny changes. Nevertheless, it is clear that all we can claim even on this level of information, is just a probability. We know that for one trait or phenotype, a variety of these differences may have influence with different impacts.

Nevertheless, despite this uncertainty and the significant amount of

questions that exist, consumerising the genetics outside of clinical context, has gained an impressive reception. The number of service providers for recreational applications is outnumbering the clinical ones. This change in paradigm and drive by consumer market is on its own an indication of the public interest. However, the more interesting point is the perception of customers and their behaviour change based on their test results. Maybe it is the automatic acceptance nod they make when they see a consistency with a trait; e.g. not interested in more than two cups of coffee and realising to be a genetically slow metaboliser of caffeine, seeing better performance in short distance running and in endurance and being genetically a sprinter, flushing quickly by drinking alcohol and being genetically sensitive, etc. As a result, they see interest and credibility to follow their personalised lifestyle based on their DNA. Notwithstanding, habit and behaviour change, is a matter of decision making system.

DUAL PROCESS THEORY: AUTOMATIC VS REFLECTIVE

We are empowered by a sophisticated and powerful system in charge. Our genetic gives us our inherited traits, it shapes our tendencies. But the brain is the system in control. When we are faced with options, having both internal and external stimuli, the brain makes a decision. However, it is not a single-processor unit loaded with a queue of tasks. Depending on the situation, the brain needs to deal with inherent and implicit demands vs the choice architecture in front of it. Some may turn into habits and automate the jobs in similar situations. The outcome will be actions we take and the behaviour we form.

Based on dual process theory, we consider two decision making systems underlying our thinking and reasoning, which have been developed through evolution. One is automatic (implicit, unconscious), and the other is reflective (explicit, controlled and conscious). The automatic system is rapid with slow effort. The reflective system is slow with high effort. Depending on the system in duty, we may have a logical/quantitative or illogical/qualitative reasoning for a reaction.



1: *The mechanics of the brain: Dual Process Theory*

A classic example is the parallel lines in figure 2. If asked which line is longer, and which shorter, the automatic system comes with a rapid answer (top one the shortest and middle one the longest). However, if the reflective system takes control, it measures the lines and proves they are the same length! Another example is multiplying two numbers. What is 2×2 ? Perhaps immediately you would say 4. Now, what is 17×31 ? To do the latter one, you feel the high effort engagement of the brain to come up with an answer. Now imagine how the effort may scale when the variety of options increase?

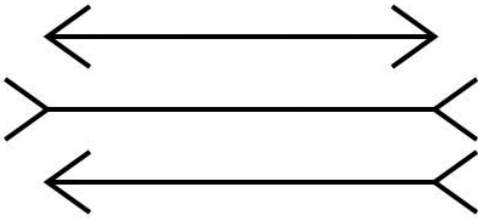

2: Parallel lines illusion

Contemplating this on our biology, if the reflective system was in charge, satisfying every desire would be absolutely calculated. As a result, perhaps everybody was on perfect diet, in good shape and in charge of their habits. But, the biology is not necessarily quantised as in digital logic. It is more of a qualitative understanding. Otherwise the scale of processing for every action and decision among a large variety of options would perhaps drain more energy than what a power plant can provide in time.

Imagine being in a supermarket to buy biscuit. There are hundreds of biscuit types in the supermarkets (c. more than 450 on Tesco's website). Which one would you go? Would you go for the low-calorie one?

The reality is the life pace is beating the life length. Immediate decisions need to be made, and demands need to be satisfied, otherwise become obsessed. As a result, a qualitative reasoning and a quick decision by the automatic system relieves us from the hassle of any decision effort. An effortless system takes over. It is not necessarily bad, as long as the system is trained with good. But the other side of the equation is the choice.

NUDGEOMICS

Over the years, personalised choice has been lost in the torment of marketing nudge theories and economics, where man-made consumer trickery overrides the true biological demand. The concept of 'consumer choice' has been completed and distorted by the techniques of the digital advertising world and the consumerism nudge. So far, this training has been structured in the concept of nudge theory based on external choice architecture to change behaviour. It has been introduced and implemented to direct people toward more optimum options.

The nudge concept has had a strong attention among different communities- behavioural psychologists, behavioural economists, neuroscientists, policy makers, etc. It is to push people in a better direction without forcing them. Nudge theory has helped in understanding how people think, make decisions and behave. It helps people to improve their thinking and their decisions, managing changes and identifying/modifying existing unhelpful influences. An example of nudge is the traffic light system in supermarkets for food. Green, yellow and red may indicate to the customer how healthy or unhealthy (!) it might be. A familiar pattern may help restricting the choices and directing the decision, while not taking away the freedom of choice from the customer.

However, the nudge concept has also been a one-for-all solution. Whereas, seeing the interest in direct-to-consumer services, recent studies such as Food4me

are investigating the influence of personalisation on such nudges. This is where biology and inherited traits come into play. It is becoming more evident that our genes may influence our desire toward different types of food. A recent study has shown that people carrying a particular gene mutation have stronger desire for fatty food, while they have less desire for sweet foods. Other examples are genes for binge eating, salt consumption, glucose response, etc.

Consequently, the idea of a DNA-based (personalised) nudge may have a stronger impact on behaviour change than a blind coarse nudge. If a choice architecture can cover the inherent proclivity, a more sustainable behaviour change may be possible.

Now, imagine you are in the same supermarket. Your genes tell you that you should not go for biscuits with high saturated fat, even though they have more calorie. Would you still go for the low-calorie one?

Nudgeomics aim to study how to nudge our macro-world based on our micro-world. A new concept to understand how our biology influences our decision making system, how our choices should be architected, and how inherently we may express desire/bias to an option, while our options are perhaps all external. The compliance and the perception of a recommendation to our actions is different when the authority is us, rather than an external body nudging (structuring) us to a common behaviour.

We have inherited our traits and have built our habits gradually. Nudgeomics studies and seeks a gradual steering toward a better us, without costing our freedom and inherent desires.

It is my DNA. It is my choice.

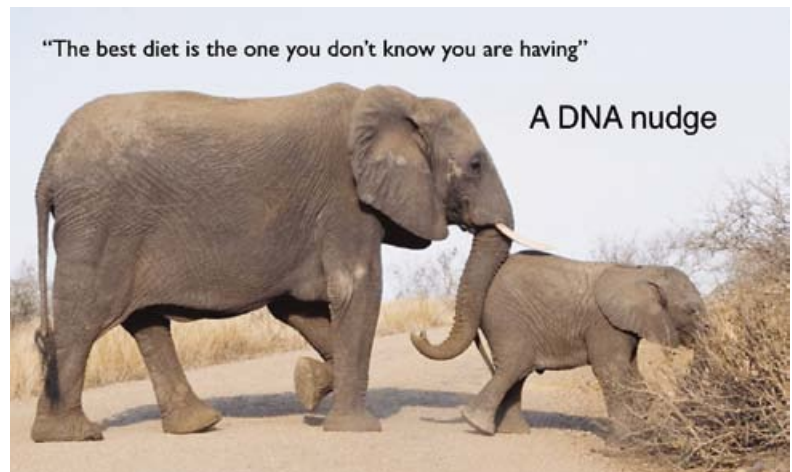

REFERENCES

- 1 Thaler, R. H., & Sunstein, C. R. *Nudge: Improving Decisions About Health, Wealth, and Happiness*
- 2 Bloss, C. S., Madlensky, L., Schork, N. J., & Topol, E. J. (2011). Genomic information as a behavioral health intervention: can it work?. *Personalized Medicine*, 8(6), 659–667.
- 3 www.food4me.org
- 4 www.livescience.com/56369-fatty-foods-preference-genetics.html
- 5 neurosciencenews.com/binge-eating-genetics-5365

Engineering rapid and sensitive electronic diagnostics for infectious disease

Dr Pantelis Georgiou, Professor Chris Toumazou, Professor Alison Holmes, Dr Jake Baum, Dr Ceire Costello, Dr Jesus Rodriguez Manzano, Dr Sara de Mateo Lopez, Dr Betty Lingshan Yu

Partners: Sophie Yacoub, Nike White, Kesinee Chotivanich, Daniel Santos Mansur, Eng Eong Oii, Yen-Hsu Chen, Sheng-Fan Wang

Funding: EPSRC Global Challenges Research Fund

Emerging and re-emerging infectious diseases are a major threat to human health, especially among countries eligible to receive official development assistance (ODA)



Infectious disease outbreaks pose an ongoing threat to human health. The numbers of dengue, Zika and chikungunya cases have sharply increased in the past few decades.

This year, new cases of Zika infection have been confirmed in Africa, Europe and Asia (Vietnam and Thailand), and Zika was declared a global health emergency by the World Health Organization (WHO). During the past five decades, the incidence of dengue has increased 30-fold. The true number is probably far worse, because severe underreporting and misclassification of dengue cases have been documented. Furthermore, Malaria is globally the most significant parasitic disease, existing in more than 100 countries. It is responsible for over half a million deaths every year, 1,200 every day, with these numbers threatening to increase due to the spread of drug resistance, emerging to the current frontline therapies. The diseases mentioned above are caused by mosquito-borne pathogens, usually found in tropical and sub-tropical regions of the world. However, the growth of infections is likely to continue, driven by international travel and climate change. If the crisis is not contained, it could negatively impact global health and economics in other developing countries on a global scale.

Worldwide monitoring of infectious diseases is the only way to control the spread. An accurate diagnosis requires nucleic acid based detection methods. Yet, such methods are usually expensive and require specialist expertise to carry out and utilize equipment that is incompatible with use in remote and limited-resource locations where surveillance and containment are critically needed. The lack of efficient worldwide monitoring and diagnostic devices has had major impacts on the treatment of patients (i.e. delayed treatment, poor patient follow-up), thereby influencing (i) control of the spread of pathogens; (ii) early detection of new strains; (iii) drug resistance assessment; and (iv) understanding of vaccine performance, development and treatment. Although some POC tests are able to confirm the infections by detecting virus-specific antibodies, they are unable to detect genetic variations within a pathogen. The importance of identifying the genetic variations have been proven to influence disease severity and treatments (e.g. hetero-serotype dengue infection may cause dengue hemorrhagic fever or dengue shock and mutations in the malaria parasite are associated with artemisinin-treatment failure), and therefore, a device that can genotype a pathogen in real-time is urgently needed.

Within the Centre of Bio-inspired Technology, and in collaboration with hospitals and experts with Imperial

College London, we are developing rapid and sensitive electronic diagnostic devices for monitoring infectious disease. Our device features pH-sensing complementary metal-oxide semiconductor (CMOS) technology which integrates more than 4,000 sensors per microchip. CMOS based detection systems allow for highly parallel investigation of pathogens by integrating a label-free platform with microfluidic technology. The potential of the 'Lab-on-a-chip' device has been proven in the detection of genetic variations in human genomic DNA. Such advances demonstrate the feasibility of a rapid, quantitative, portable, ultra-sensitive device for pathogen detection which meets WHO ASSURED criteria (Affordable, Sensitive, Specific, User-friendly, Rapid and Robust, Equipment-free, Delivered). In addition, we are uniquely placed to undertake this project: Our team involves microbiologists, infectious diseases doctors,

bio-informaticians and electrical engineers. We have included partners from Vietnam, Brazil, Thailand, Singapore and Taiwan. These countries are particularly affected by Flavivirus epidemics and the spread of antimalarial drug resistance and have therefore the ideal partners to ensure the real applicability and impact of the technology.

The EPSRC Global Challenges Research Fund has allowed us to establish a collaborative international network necessary to develop novel POC diagnostics for ODA countries. Our pilot data has shown the capability of reducing the diagnostic time from 1–2 days to one hour. Our next step is to create a first-of-its-kind diagnostic platform for emerging diseases that is both commercially sustainable and globally deployable. We believe that this platform represents a significant and long-lasting contribution to global health.

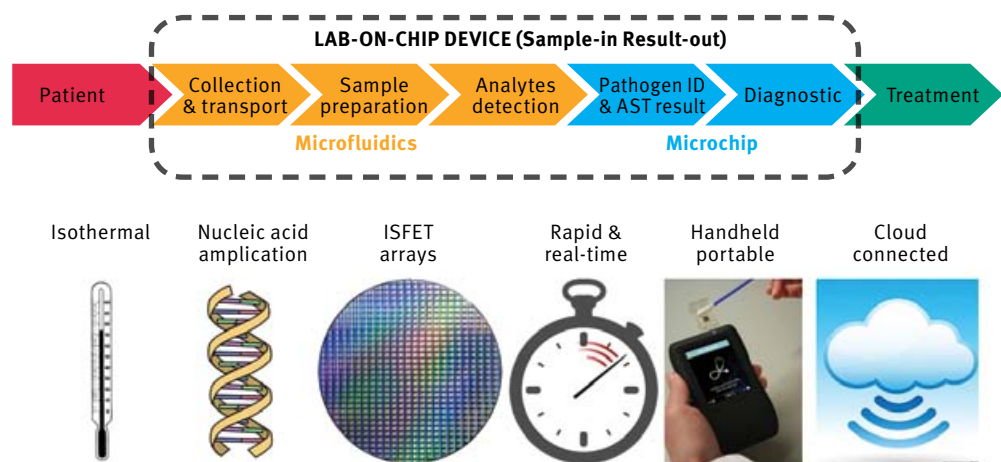

A first-of-its-kind diagnostic platform for emerging diseases

Chip gallery

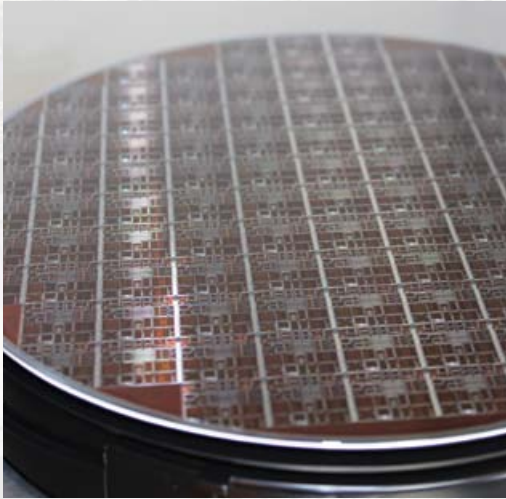

Our microelectronics design effort has been particularly productive this past year. With a number of our key projects requiring integrated circuit prototyping, the Centre has been able to, for the first time undertake a dedicated engineering (single die tooling) run in AMS 0.35 μ m HV CMOS technology.

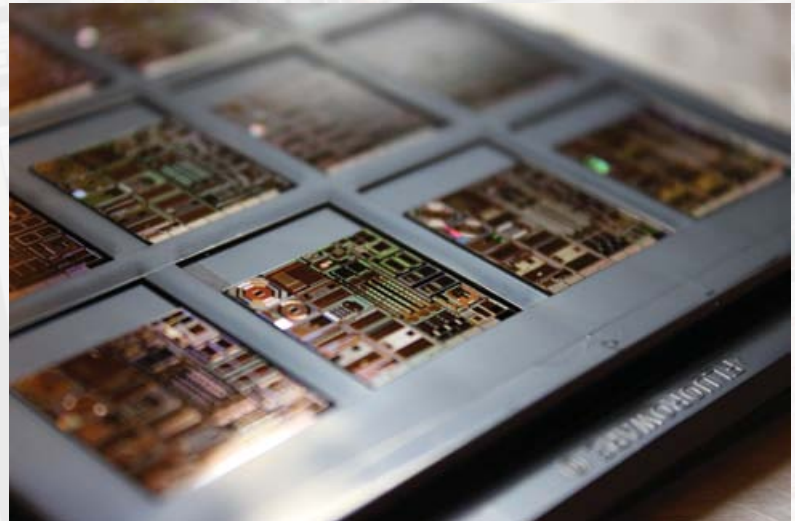

Photograph of the 16mm x 16mm reticle

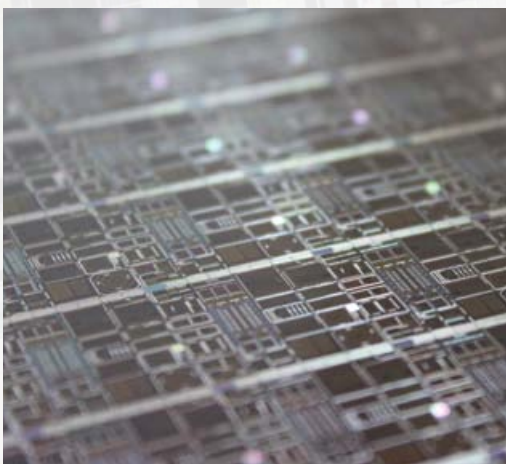
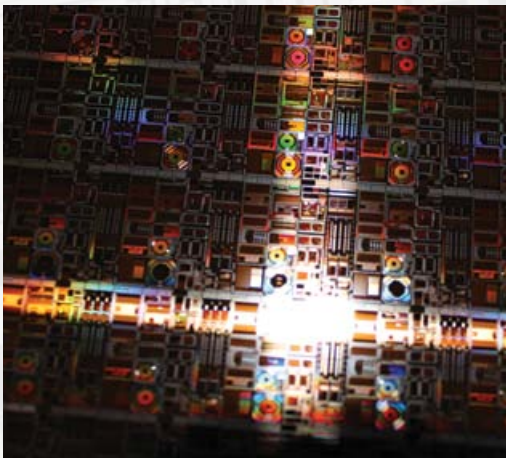

The manufactured 200mm wafer with 95 repetitions of each design

This design has involved the effort of over twenty researchers, resulting in 15 unique SoCs (system on chips) and 6 test chip designs, all for biomedical applications. These have been organized as 17 dies occupying a 16mm x 16mm reticle. This effort was directly supported by both the foundry and Europractice IC service (via Fraunhofer IIS). We are also grateful to our funders for providing us with the resource to support this activity.

Layout design of the 16mm x 16mm reticle

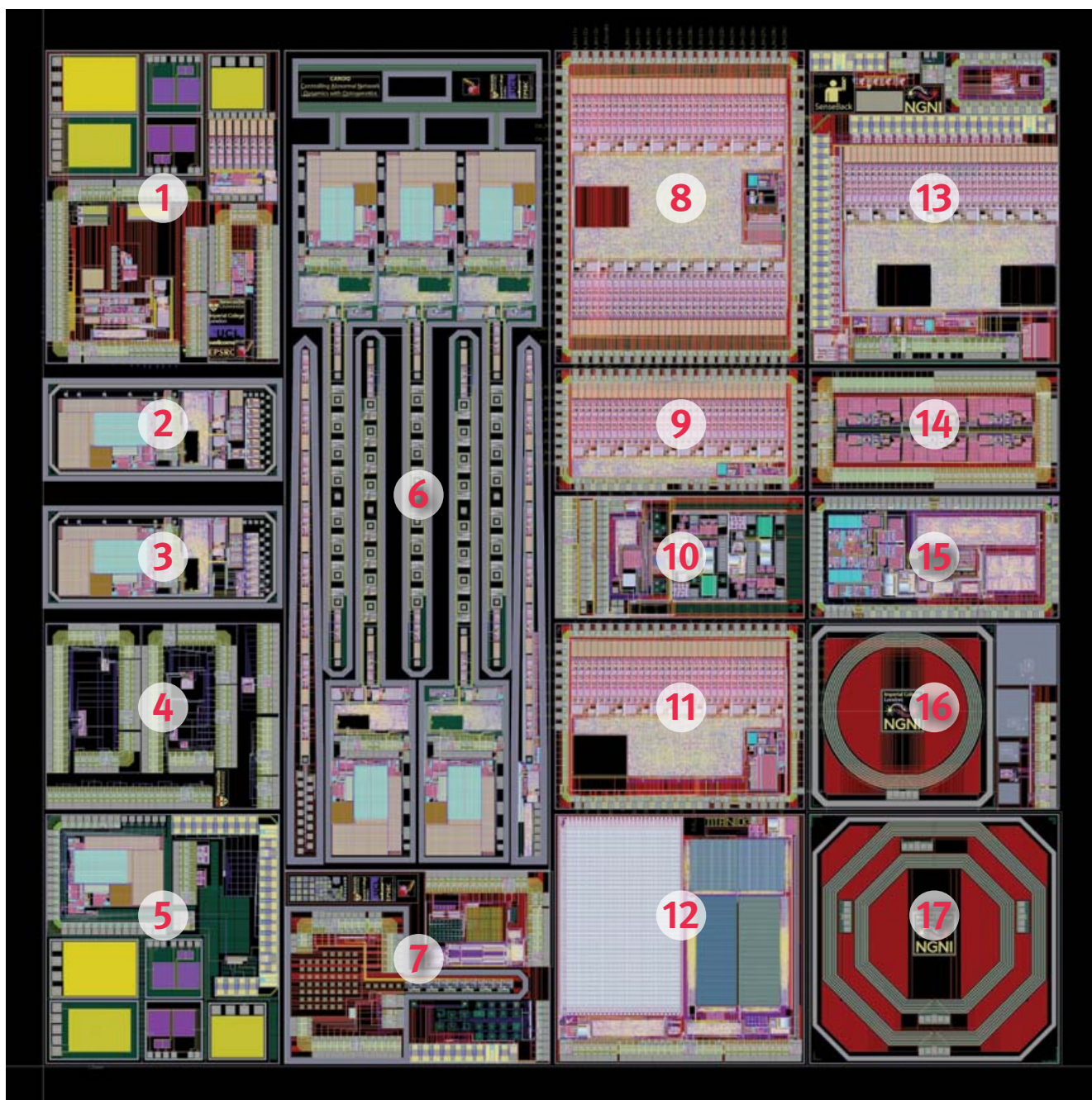

1 CBIT16F01 (CANDO1)

Dimensions: 3700µm x 4900µm

Purpose: Test chip including neural recording circuits, unique ID generation devices, structures for long term implant reliability (CANDO project)

Designers: Dorian Haci, Federico Mazza, Sara Ghoreishizadeh, Yan Liu, Timothy Constandinou

2 CBIT16F02 (CANDO2)

Dimensions: 3800µm x 1600µm

Purpose: “Head-only” SoC for implantable optrode – conservative design (CANDO project – see CBIT16Fo6 for further info)

Designers: Yan Liu, Sara Ghoreishizadeh, Dorian Haci, Timothy Constandinou, in collaboration with Newcastle University (Reza Ramezani, Fahimeh Dehkhoda, Ahmed Abd-El-Aal, Patrick Degenaar)

3 CBIT16F03 (CANDO3) – Risky head only

Dimensions: 3800µm x 1600µm

Purpose: “Head-only” SoC for implantable optrode – risky design (CANDO project – see CBIT16Fo6 for further info)

Designers: Yan Liu, Sara Ghoreishizadeh, Dorian Haci, Timothy Constandinou, in collaboration with Newcastle University (Reza Ramezani, Fahimeh Dehkhoda, Ahmed Abd-El-Aal, Patrick Degenaar)

4 CBIT16F04 (CANDO4) – Test circuits NCL

Dimensions: 3700µm x 2900µm

Purpose: Test chip including optoelectronic drive circuits, reliability test (CANDO project)

Designers: Yan Liu, Sara Ghoreishizadeh, Dorian Haci, Timothy Constandinou, in collaboration with Newcastle University (Reza Ramezani, Fahimeh Dehkhoda, Ahmed Abd-El-Aal, Patrick Degenaar)

5 CBIT16F05 (CAND05)

Dimensions: 3700µm x 3900µm

Purpose: Test chip including 4-wire intrabody communication system, AC/DC and DC/DC power conversion circuits, non-volatile memory devices

Designers: Dorian Haci, Sara Ghoreishizadeh, Federico Mazza, Peilong Feng, Yan Liu, Timothy Constandinou

6 CBIT16F06 (CAND06)

Dimensions: 4200µm x 12800µm

Purpose: Implantable optrode SoCs for bidirectional neural interfacing with embedded reliability test, control, power management and in-body power transfer/full-duplex communication (CANDO project)

Designers: Yan Liu, Sara Ghoreishizadeh, Dorian Haci, Timothy Constandinou, in collaboration with Newcastle University (Reza Ramezani, Fahimeh Dehkhoda, Ahmed Abd-El-Aal, Patrick Degenaar)

7 CBIT16F07 (CAND07)

Dimensions: 4200µm x 3000µm

Purpose: Test chip including probe design for optogenetic stimulation, chemical microsensors, and structures for surface characterization

Designers: Yan Liu, Sara Ghoreishizadeh, Dorian Haci, Katarzyna Szostak, Timothy Constandinou, Nicolas Moser, Nicholas Miscourides, Pantelis Georgiou, in collaboration with Newcastle University (Reza Ramezani, Fahimeh Dehkhoda, Ahmed Abd-El-Aal, Patrick Degenaar)

8 CBIT16F08 (NGNI64)

Dimensions: 3900µm x 4900µm

Purpose: 64-channel event-driven SoC for neural recording with independent channel configuration, and in-channel DSP for filtering, LFP selection, and spike detection.

Designers: Song Luan, Yan Liu, Ian Williams, Timothy Constandinou

9 CBIT16F09 (NGNI32D)

Dimensions: 3900µm x 1900µm

Purpose: 32-channel SoC for neural recording

Designers: Song Luan, Yan Liu, Ian Williams, Timothy Constandinou

10 CBIT16F10 (MOONCAKE)

Dimensions: 3900µm x 1900µm

Purpose: SoC for DNA detection, and low power on-chip glucose detection

Designers: Dora Ma, Sara Ghoreishizadeh, Pantelis Georgiou, Chris Toumazou

11 CBIT16F11 (NGNI32)

Dimensions: 3900µm x 2900µm

Purpose: 32-channel event-driven SoC for neural recording (NGNI/iPROBE project – see CBIT16Fo8 for further info)

Designers: Song Luan, Yan Liu, Ian Williams, Timothy Constandinou

12 T16F12 (TITANICKS)

Dimensions: 3900µm x 3900µm

Purpose: Chemical sensing array for DNA detection

Designers: Nicolas Moser, Nicholas Miscourides, Pantelis Georgiou

13 CBIT16F13 (SENSEBACK)

Dimensions: 3900µm x 4900µm

Purpose: 32-channel bidirectional neural/EMG interface, test circuits (SenseBack project), and continuous-time data converter for neural signal tracking

Designers: Ian Williams, Adrien Rapeaux, Michal Maslik, Song Luan, Yan Liu, Timothy Constandinou

14 CBIT16F14 (I2MOVE)

Dimensions: 3900µm x 1900µm

Purpose: Multichannel front-end interface for biomedical sensing of signals for the treatment of obesity

Designers: Nishanth Kulasekaram, Khalid Mirza, Chris Toumazou

15 CBIT16F15 (ATLAS)

Dimensions: 3900µm x 1900µm

Purpose: Wearable EMG and chemical recording sensory systems for healthcare applications

Designers: Ermis Koutsos, Matt Douthwaite, Pantelis Georgiou

16 CBIT16F16 µµ(ENGINI1)

Dimensions: 3900µm x 2900µm

Purpose: Test chip for implantable microsystem (on chip inductors, humidity sensors, hermetic micropackaging)

Designers: Federico Mazza, Peilong Feng, Katarzyna Szostak, Timothy Constandinou

17 CBIT16F17 (ENGINI2)

Dimensions: 3900µm x 3900µm

Purpose: Test chip for implantable microsystem (on chip inductors, hermetic micropackaging)

Designers: Peilong Feng, Katarzyna Szostak, Timothy Constandinou

See our complete 'Chip Gallery' online at:
www.imperial.ac.uk/bio-inspired-technology/resources/chip-gallery/

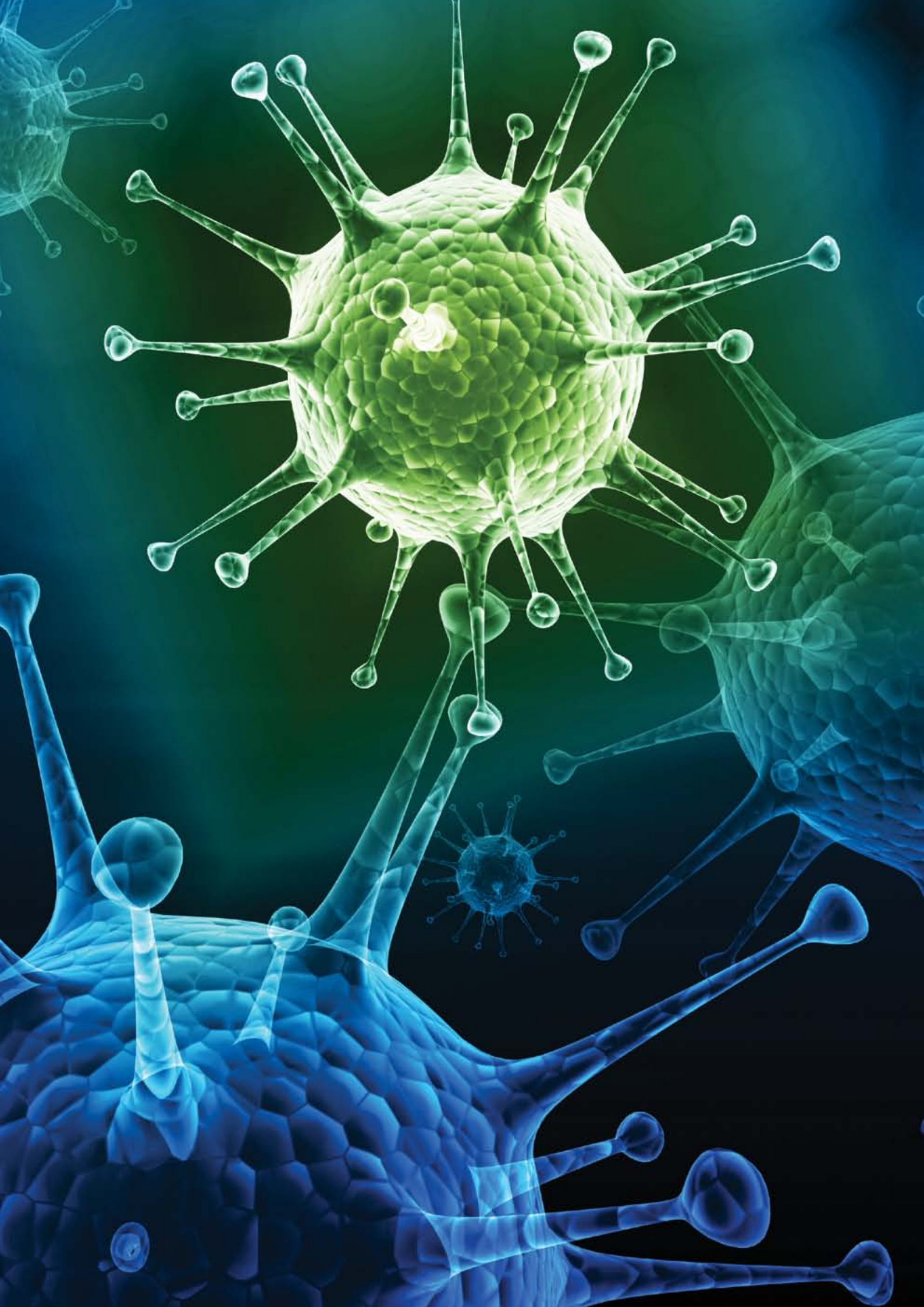

The laboratory areas have been designed to meet the needs of the four main application areas within the Centre's research strategy. Researchers have been able to undertake a large number of high-quality research projects in the Centre by leveraging on the multidisciplinary expertise of their colleagues and collaborators and the employment of the facilities.

Research facilities

The main thrust of the research strategy is not to further advance the performance of existing electronic systems but to enable entirely new applications by utilizing well-established technologies in new, innovative ways. All members of the Centre have access to the full range of facilities and equipment and some researchers have developed a high level of expertise in specific areas to ensure that these are exploited to the full.

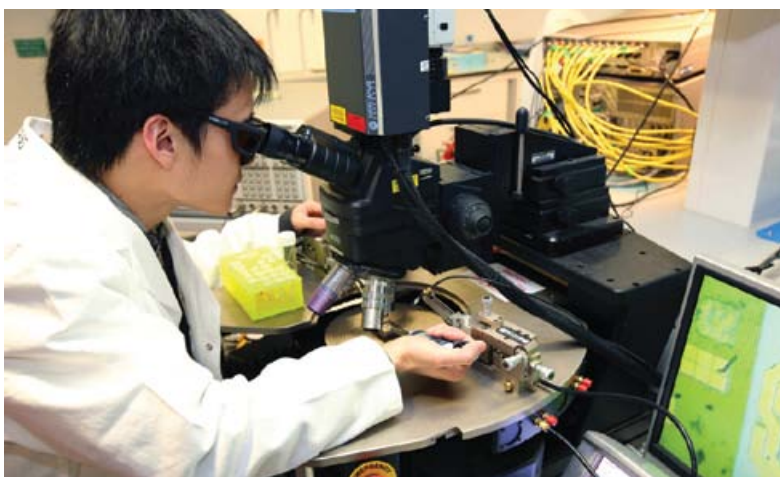

EDA AND CAD FACILITY

Software tools and computer aided design (CAD) is an essential aspect for designing modern medical and electronic systems. The compute infrastructure provided by the CAD laboratory the design environment for microelectronics, microsystems



(including MEMS, microfluidics), RF/microwave devices, mechanical design, etc. Researchers regularly develop application – specific integrated circuits (ASICs) using the Lab's workstations which are then fabricated using commercially available foundry services. The facility has licensed all industry standard tools including Cadence, Mentor Graphics, Synopsys, Ansys, Solidworks, and several others, and a range of modern process technologies down to the 45nm node. Moreover this provides support for machine virtualisation, distributed computing and remote access that enabled accelerated chip development for users in and outside of the laboratory.



MICROELECTRONICS TEST LABORATORY

This laboratory is comprehensively equipped for the development, testing and measurement of biomedical circuits and systems. Such devices often require low noise instrumentation operating at relatively low frequency and have ultra low power requirements. This facility includes instruments for semiconductor characterisation, equipment for time, frequency and impedance characterisation (e.g. oscilloscopes, spectrum analysers, CV), instruments for low noise transimpedance and voltage amplification, signal generation, a semi-automatic probe station with laser for trimming and failure analysis, a temperature chamber, PCB rapid prototyping facility (LPKF-based), and all standard electronic test & measurement equipment.

ELECTROMAGNETICS TEST LABORATORY

Within this facility is a large, shielded, certified anechoic chamber, valid up to 34GHz, a 67GHz Agilent PNA with Cascade manual probe station and E-CAL automatic calibration for discrete SMA socketed use (up to 26.5GHz), an 8GHz 40Gs/s Agilent oscilloscope and a Picosecond pulse generator, as well as a host of other miscellaneous instruments. It is unique for the Centre to have access to such a chamber and it provides an ideal test facility for any project involving on-body or in-body antennas and indeed the communication between both. This, in conjunction with equipment such as the Agilent PNA and Dielectric Probe facilitates the use of anatomically and electromagnetically correct bio-phantoms to replicate the losses incurred when sensors and antennas are implanted in the body, leading to quicker prototype development and proof of concept.

ANECHOIC (RF AND ACOUSTIC) TEST CHAMBERS

State-of-the-art soundproof and electromagnetic radiation proof chambers for ultra-low noise sensing. The acoustic facility includes a large (5m x 5m x 2m) anechoic shielded chamber providing an extremely low-noise environment suitable for all low frequency acoustic, optical and mechanical device/sensor characterisation. The RF facility includes a large (4m x 3m x 2m) anechoic shielded chamber suitable for a wide range of low noise measurements with significantly attenuated electromagnetic levels. This has been calibrated for uninterrupted use between 10MHz and 34GHz.

CLEANROOM SUITE

The Centre has a suite of two ISO class 6 cleanrooms (equivalent to US standards class 100). These have been designed to support CE Marking/FDA approvals, to class 100/1000 to develop biosensor devices, electrode and microfluidic fabrication and packaging/post-processing of CMOS chips. The largest room, the 'yellow' room, houses most of the fabrication tools/processes and all relevant inspection and measurement facilities. This includes photolithography (SUSS MA6/BA6), sputtering/evaporation for film deposition of metals/oxides (BOC Edwards Auto 500), surface characterisation (Veeco Dektak 6M stylus profiler), plasma chamber, wet and dry benches, parylene conformal coating (SCS parylene deposition), microscopy and wirebonding.

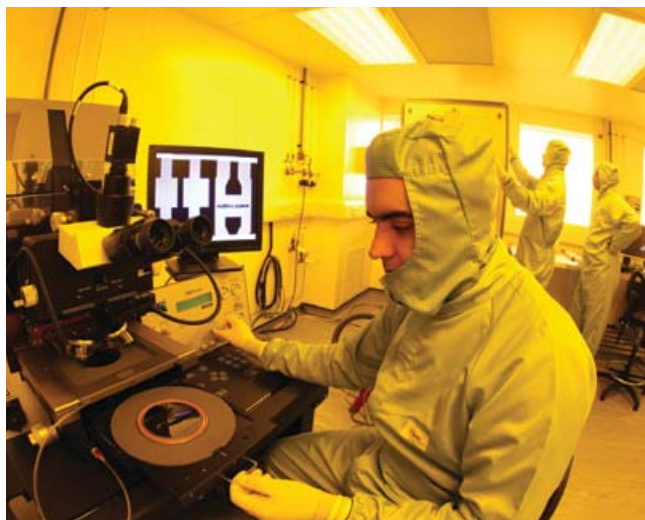

APPLICATION SPECIFIC TECHNOLOGY LABORATORIES

In addition to the state-of-the-art "general use" laboratories, the Centre additionally has three specialist laboratories that are application-specific to: Neural interfaces and Neuroprosthetics, Metabolic Technology and Genetic Technology. These laboratories provide application-specific facilities that are research-specific. For example, biosensor characterisation for metabolic technology, low noise biopotential recording for neural interfaces, etc.

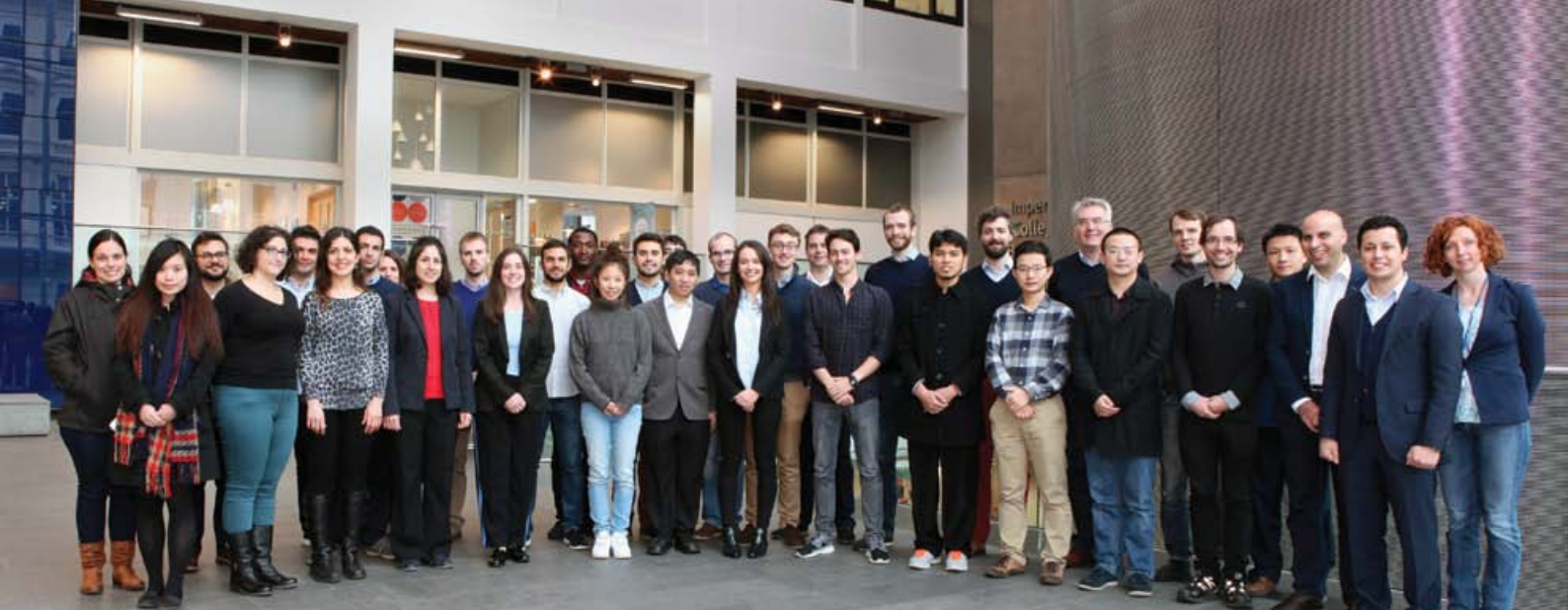

Who we are

Academic staff profiles — 30

Administrative staff profiles — 35

Staff research reports — 36

Research student & assistant reports — 57



Professor Chris Toumazou

Regius Professor of Engineering
 Director, Centre for Bio-Inspired Technology
 Chief Scientist, Institute of Biomedical Engineering
 Winston Wong Chair in Biomedical Circuits, Department of Electrical and Electronic Engineering

Toumazou's life work has been dedicated to saving and improving lives through the invention of revolutionary, innovative and disruptive technology and the creation of a leading edge medical research institute and three commercial ventures to commercialize his research.

Toumazou is a Professor of Analog Circuit Design, Chief Scientist and Founder of Imperial's first Institute of Biomedical Engineering, Research Director of the Centre for Bio-inspired Technology, and Winston Wong Chair in Biomedical Circuits at the Electrical and Electronic Engineering Department at Imperial College London. He was made a Professor at Imperial College London at 33, one of the youngest ever to achieve this distinction. In 2013 he was appointed the first Regius Professor of Engineering, an award made to Imperial College London to celebrate the Diamond Jubilee of Her Majesty The Queen.

Toumazou's career began with the invention and development of entirely novel concept of current-mode analogue circuitry for ultra-lowpower electronic devices. Since then, he has been involved in inventing, developing and demonstrating new technologies to meet a range of healthcare challenges – mainly applying silicon chip technology to biomedical and life-science applications, most recently to DNA analysis. In particular, Toumazou invented and licensed Portable and Rapid Semiconductor Genome Sequencing which has now become a multi-million dollar industry. One of his motivators was the diagnosis of his 13-year old son with end-stage kidney failure through a rare genetic mutation.

DNA Electronics, a company founded by Toumazou in 2003, was awarded \$51.9 million contract to DNAe to develop semiconductor DNA sequencing platform for rapid diagnosis of antimicrobial resistant infections and influenza by the Biomedical Advanced Research and Development Authority (BARDA) a division in the U.S. Department of Health and Human Services (HHS).

In 2015 he co-founded dnaNUDGE pioneering a new breed of consumer genetics testing. The company harnesses groundbreaking DNA testing and application technology to 'nudge' people towards healthier shopping choices based on their unique genetic profile. The vision for dnaNUDGE is improved public health, driven by consumers empowered by the information and assistive app technology to help them make healthiest choices for their genetic characteristic.

In 2003 he raised a total of £26m to create the Institute of Biomedical Engineering at Imperial College London, a multidisciplinary research institute and hub focusing on personalised medicine and bionanotechnology. He became its first Director (2004) and Chief Scientist (2011). His own specialism is in the field of personalised healthcare, providing wearable or implantable devices for early diagnosis and detection of disease.

He was elected Fellow of the Royal Society (2008), Fellow of the Royal Academy of Engineering (2008) and Fellow of the Academy of Medical Sciences (2013), making him one of a handful in the UK who are fellows of all three premier societies. Toumazou has received numerous awards and prizes for his innovative research including the 2009 World Technology Award for Health and Medicine, the Silver Medal of the Royal Academy of Engineering in 2007 and in 2010 Honorary DEng from Oxford Brookes University. In 2009 he gave the Keynote Lecture to mark the IEEE 125th Anniversary celebrations in Europe at the Royal Institution. He has given numerous public lectures and keynote addresses at a national and international level. In 2011 he was invited to speak at the TEDMED conference in San Diego; his lecture entitled 'When Will Wireless Medicine Change Healthcare'. Other notable lectures include the G8 Summit (2013) and Royal Society public talk (2011).

In June 2014 Professor Toumazou's technology was also recognised by the European Patent Office when he was awarded the prestigious 2014 European Inventor of the Year Award for Research making him the first British winner since 2008. Toumazou has also been awarded by Cardiff University with Honorary Fellowship in 2014 and later that year – in November 2014 – the Faraday Medal, the highest honour of the UK's Institution of Engineering and Technology (IET) for the invention of semiconductor sequencing and pioneering work that has led to disposable semiconductor healthcare.

To date Chris has published over 750 research papers and holds more than 50 patents in the field of semiconductors and healthcare, for which he has received many awards and honours.



Timothy Constandinou, PhD

Reader in Neural Microsystems – Department of Electrical & Electronic Engineering
Deputy Director – Centre for Bio-Inspired Technology

Dr Timothy Constandinou is a Reader in Neural Microsystems at Imperial College London and also Deputy Director of the Centre for Bio-inspired Technology. He received both his BEng and PhD degrees in Electrical and Electronic Engineering from Imperial College London, in 2001 and 2005 respectively. He then joined the Institute of Biomedical Engineering as Research Officer until 2009, when he was appointed Deputy Director of the newly formed Centre for Bio-Inspired Technology. In 2010, continuing as Deputy Director, he joined the Department of Electrical & Electronic Engineering, where he currently holds an academic faculty position within the Circuits & Systems research group.

He leads the Next Generation Neural Interfaces (NGNI) research group (www.imperial.ac.uk/neural-interfaces) at Imperial; a multidisciplinary team of approx. 15–20 full time researchers. The group utilizes integrated circuit and microsystem technologies to create advanced neural interfaces that enable new scientific and prosthetic applications. The ultimate goal is to develop devices that interface with neural pathways for restoring lost function in sensory, cognitive and motor impaired patients.

During his career he has contributed to several projects from concept through to working demonstrator. This includes developing a fully implantable cochlear prosthesis for the profoundly deaf (2001–2), biologically inspired vision chips (2003–5) and an implantable vestibular prosthesis for balance restoration (2006–9). His latest research (2010 onwards) has focused on two key themes:

- **Resource efficiency:** developing low power/area/communication bandwidth real-time systems for neural interfacing that combine recording, processing, stimulation and communication.
- **Microsystems integration:** taking a holistic approach in the design process driven by the physical embodiment (packaging/encapsulation, deployment, power, etc), in particular for implantable and wearable devices.

Current projects include:

- **EPSRC Early Career Fellowship (ENGNI) – Empowering Next Generation Implantable Neural Interfaces:** creating truly wireless, autonomous, chip-scale implants for distributed sensing.
- **CANDO – Controlling Abnormal Network Dynamics with Optogenetics (supported by the Wellcome Trust and EPSRC):** a next generation brain pacemaker for the treatment of drug-insensitive epilepsy (in collaboration with Newcastle University, Newcastle Upon Tyne Hospitals and UCL).
- **Enabling Technologies for Sensory Feedback in Next Generation Assistive Devices (supported by the EPSRC):** a platform for providing sensory feedback via a PNS interface in upper-limb prosthetics (in collaboration with the Universities of Newcastle, Southampton, Leeds, Keele, and Essex).
- **iPROBE – *in-vivo* Platform for the Real-time Observation of Brain Extracellular activity (supported by the EPSRC):** a digital 1k+ channel scalable neural recording interface for neuroscience research (in collaboration with Newcastle University, University of Leicester and UCL).
- **Investigating new modalities for observing neural activity (supported by EPSRC DTAs and platform), including:** “functional neuroimaging using ultra-wideband impulse radar” and “optical neural recording (without optogenetics) for large-scale activity monitoring”.

Within the IEEE and IET he serves on several committees/panels, etc, regularly contributing to conference organization, technical activities and governance. He is currently associate editor of IEEE Trans. Biomedical Circuits & Systems (TBioCAS), is chair-elect of the IEEE Sensory Systems Technical Committee, a member of the IEEE BRAIN Initiative Steering Committee, member of IEEE BioCAS Technical Committee, and recently been elected to the IEEE Circuits & Systems Society Board of Governors (BoG) for the term 2017–19. He was Technical Program Chair of IEEE BioCAS conference (Paphos, 2010 and San Diego, 2011), General Co-Chair of 1st IEEE BrainCAS workshop (Hangzhou, 2016), and is Special Session Chair of IEEE ISCAS (Baltimore, 2017), and Demonstrations Chair of IEEE BioCAS (Turin, 2017). He currently chairs the IET Awards & Prizes committee (2015–17) and also serves on the IET Knowledge Services Board.



Pantelis Georgiou, PhD

Senior Lecturer in Circuits and Systems – Department of Electrical and Electronic Engineering
 Director – Bio-Inspired Metabolic Technology Laboratory, Centre for Bio-Inspired Technology

Pantelis Georgiou is a Senior Lecturer within the Department of Electrical and Electronic Engineering and is the director of the Bio-inspired Metabolic Technology Laboratory in the Centre for Bio-Inspired Technology; He received the MEng (Hons) degree in Electrical and Electronic Engineering in 2004 and a PhD degree in 2008 both from Imperial College London. He then moved to the Institute of Biomedical Engineering where he was appointed as a research fellow and head of the Bio-inspired Metabolic Technology lab. In 2011, continuing his role in the centre, he joined the Department of Electrical & Electronic Engineering, where he currently holds an academic faculty position within the Circuits & Systems research group.

His current research includes low-power microelectronics, bio-inspired design, integrated sensing systems, Lab-on-CMOS and development of novel medical devices. One of his key research focuses is on new technologies for treatment of Diabetes such as the artificial pancreas but also develops wearable technologies for physiological signal monitoring and novel lab-on-chip technology with application in genomics and diagnostics targeted towards infectious disease and antimicrobial resistance (AMR). In 2004 he was awarded the Imperial College Governors' Prize for Electrical and Electronic Engineering and in 2013 he was awarded the IET Mike Sergeant award for outstanding achievement in engineering and his work on the Bio-inspired Artificial pancreas.

Some of his current research projects include:

- **The bio-inspired artificial pancreas** – Type 1 diabetes results in the inability to produce insulin resulting in extremely high blood glucose. Current methods of control lead to many secondary complications such as blindness, kidney failure and heart disease. This project aims to create a closed-loop system for tight glycaemic control inspired by the biology of the pancreas. The bio-inspired artificial pancreas controls blood glucose continually through intensive insulin infusion improving quality of life and reducing adverse effects of diabetes.
- **Decision support systems for management of diabetes** – Self-management of Type 1 and Type 2 diabetes is an extremely difficult task. To minimise the adverse effects good control through intensive insulin infusion is required for insulin dependent diabetes and controlled exercise and diet for

no-insulin dependent diabetes. This research aims to create novel decision support systems to control glucose in diabetes through guided supervision. It is capable of factoring in multiple parameters such as blood glucose, exercise, meals and stress, all of which effect outcome.

- **Next generation ISFET arrays for ion-imaging and point-of-care diagnostics**– Semiconductor based chemical sensing using Lab-on-CMOS platforms is becoming an attractive alternative to conventional optical sensing due to the capability to integrate millions of sensors on a single substrate to create sensing arrays, ability to create small form factor point-of care diagnostics, and low cost associated with the economies of scale of silicon. My lab is developing next generation chemical sensing arrays using Ion-sensitive Field Effect transistors. Our applications include diagnostics for bacterial genotyping and pathogen detection to combat Antimicrobial Resistance and Infection in the hospitals in addition to ion-imaging to create point-of-care systems for multiple metabolite monitoring. A key driver is towards developing countries with collaborating countries such as Brazil, Thailand, Vietnam, South Africa, Singapore and Taiwan targeting infections which include Dengue, Zika, Chikungunya, Malaria and Tuberculosis.
- **Real time muscle fatigue detection for smart rehabilitation** – This project will create a real-time method for tracking muscle fatigue for applications in rehabilitation and sport physiotherapy. Through specific continuous time techniques, an energy efficient, miniaturised system will be developed in CMOS that extracts muscle fatigue through monitoring of EMG. More importantly this system will be information driven rather than conventionally data driven, reducing requirements on data transmission and thus saving power.

Dr Georgiou is a senior member of the IEEE (Institution of Electrical and Electronic Engineers), a member of the IET (The Institution of Engineering and Technology) and a Chartered Engineer (CEng). He serves on the BioCAS (Biomedical Circuits and Systems) and Sensory Systems technical committees of the IEEE CAS Society. He is an associate editor of the IEEE Sensors and TBioCAS journals. He is also the CAS representative on the IEEE sensors council. He also sits on the IET Awards and Prizes committee.



Professor Chris McLeod

Principal Research Fellow, Centre for Bio-Inspired Technology

Chris McLeod was appointed Principal Research Fellow in Cardiovascular Instrumentation in 2009 after joining the IBE at its inception in 2005 as a Visiting Professor. Until 2008 he had been a Professor of Electronic Engineering at Oxford Brookes University where he led research in Medical Devices in collaboration with the clinical departments of Anaesthetics, Neurophysiology and Paediatrics, holding an Honorary Research Fellowship in the Department of Anaesthetics. The research activities were mainly funded by the Wellcome Trust and EPSRC. Prior to joining Oxford Brookes he worked with clinical research groups in Paediatrics and the Nuffield Institute for Medical Research in Oxford. He received an MA degree in Engineering from Cambridge, an MSc in Bioengineering from Strathclyde and a D.Phil in Bioengineering from Oxford.

His research has, in the past, been based on minimally-invasive sensing of physiological data for patients in intensive care, both adult and neonatal, to improve the quality of signals, to increase the value of recorded signals and to decrease the obtrusiveness of recording apparatus. He currently leads the research group developing permanently implantable sensors for monitoring the cardiovascular system in ambulatory patients at home with long-term conditions and piloting implantable sensors for other medical applications. The monitoring system delivers objective data to a clinician or server through a wide-area network. The sensors are based on acoustic resonators which can be powered and interrogated wirelessly from the body surface.

MOTIVATION FOR CURRENT RESEARCH

There is a hypothesis that objective measurements of Pulmonary Arterial Pressure can be used to determine the optimal pharmaceutical therapy for patients with progressive heart failure. If optimal, patients will have the minimum morbidity (i.e. best achievable quality of life) and disease progression will be retarded. Early indications from permanently implanted sensors measured once daily in an American trial (CHAMPION) show a significantly reduced re-hospitalisation rate in patients. We believe that an ambulatory monitoring regime will further improve the data available to optimise therapy, with the added potential of being a clinical alarm system.

His current research and development programme is funded by the Wellcome Trust and Department of Health for which he is extremely grateful. The IBE at Imperial has been an excellent base for this activity, so thanks also to Chris Toumazou for making him welcome here.

PUBLICATIONS AND/OR KEY REFERENCES

- C.N.McLeod, R.Harding, P.Johnson, M.E.McClelland, P.L.Whyte Studies on the Control of Respiration and Behaviour during Development in Ewe-reared Lambs. *Biotelemetry* (1978) 4:63–68.
- A.B.Baker and C.N.McLeod. Oesophageal Multipurpose Monitoring Probe. *Anaesthesia* (1983) 38:892–897.
- K. Paulson, S. Jouravleva, CN. McLeod “Dielectric Relaxation Time Spectroscopy” *IEEE-BME Vol 47 no.11 pp1510–7, (2000)*
- *Kerrouche N, McLeod CN & Lionheart WRB ‘ Time series of EIT chest images using singular value decomposition and Fourier transform’. *Physiol Meas* 22(1) pp 147–158. (2001)

Simultaneous recordings of porcine left ventricular pressure from a catheter-tip transducer (green) and SAW sensor (blue)

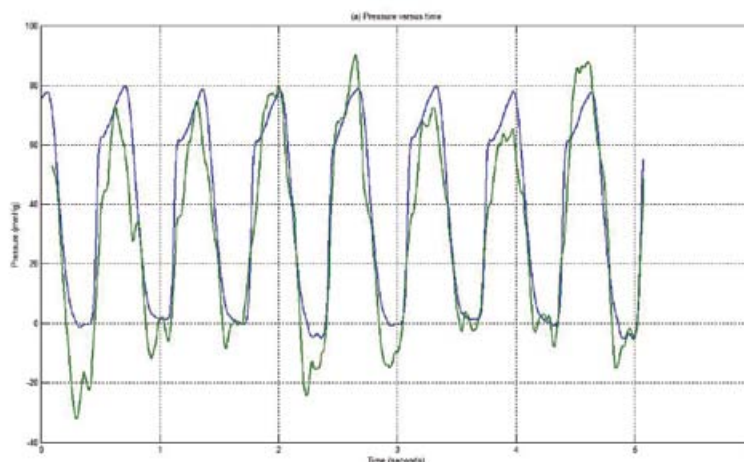



Konstantin Nikolic, PhD

Senior Research Fellow

Konstantin received a DiplEng and Masters from the Department of Electrical Engineering, Belgrade University, Serbia and a PhD in Condensed Matter Physics from Imperial College London. He was a Lecturer and Associate Professor at the Faculty of Electrical Engineering, Belgrade University (teaching Physics, Quantum Mechanics and Semiconductor Devices) in the period 1994-1999. Then he moved to UCL (Department of Physics and Astronomy, Image Processing Group) until he joined the Institute of Biomedical Engineering, Imperial College London in 2005. In 2006 he became Corrigan Research Fellow and in 2012 Senior Research Fellow.

The Bio-modeling group develops methods and computational tools for understanding, modelling and simulating various biological and physiological processes and their applications in bio-inspired electronic systems. Bio-modelling tries to capture the complexity of biophysical, biochemical and bioinformatic processes at different scales, from individual molecules to complete organisms, in relatively simple models. These models and computational simulations provide useful insights, and represent a fundamental basis in understanding how to design new bio-inspired devices.

Dr Nikolic is also collaborating and/or managing several projects related to neural recording and stimulation.

Current projects include:

- **Prometheus** – A publicly available web Portal for Computational Neuroscience along with a Graphical User Interface (BBSRC Impact Acceleration Award, PI). It provides the tools for computational optogenetics (PyRhO) together with the NEURON and Brian2 platforms available with no installation or configuration, eliminating all related potential frustrations to users, especially those with a limited computational background. The portal is currently hosted on the Digital Ocean cloud infrastructure <http://try.projectpyrho.org>

- **PyRhO** – Multiscale Computational Platform for Optogenetics (BBSRC funding, PI). The module is written in Python with an additional IPython/Jupyter notebook based GUI, allowing models to be fit, simulations to be run and results to be shared through simply interacting with a webpage. The model fitting algorithms are seamlessly integrated with simulation environments, including NEURON and Brian2
- **Cancer Breathalyser** – Development of a machine learning algorithm for a breathalyser device for cancer detection (Wellcome-Imperial Strategic Support, Co-I). The project also includes a statistical analysis of the volatile organic compounds concentrations in the exhaled breath for searching for markers for different types of cancers.
- **Platform Grant for Disruptive Semiconductor Technologies for Advanced Healthcare Devices (EPSRC, Co-I)**. Provides support and ‘platform’ for initiating, testing and finding a longer term support for a number of new ideas in the area of cancer detection, neural recording and stimulation, and anti-microbial resistance research, as well as for keeping existing expertise and talent in the group and bringing new.
- **izMOVE** – Intelligent Implantable Modulator of Vagus Nerve function for treatment of obesity (ERC). The project develops a new generation of neural interfaces that combines novel electrode materials, structures and sensing modalities with low power electronic neural recording, analysis, stimulation and wireless communication.

Dr Nikolic is a member of the IEEE Biomedical Circuits and Systems (BioCAS) Technical Committee, EPSRC Peer Review College member, and IEEE BioCAS conference review committee member for Medical Information Systems and Bioinformatics.

ADMINISTRATIVE STAFF PROFILES



www.imperial.ac.uk/people/w.hsissen

Wiesia Hsissen

Senior Group Administrator, Circuits and Systems Research Group, Department of Electrical and Electronic Engineering



www.imperial.ac.uk/people/g.osei-ansah

Gifty Osei-Ansah

PA to Professor Chris Toumazou

Wiesia is the senior group administrator of the Circuit and Systems (CAS) research group and additionally has the role of PA to the Head of Department. She joined the Department of Electrical and Electronic Engineering in 1990 and has kept a key role in supporting the CAS group ever since.

Her role within the Centre for Bio-Inspired Technology is to support our postgraduate research students from PhD registration and bursaries to thesis submission and examination.

Gifty joined the Centre in 2010 as PA to Professor Toumazou. She provides the essential support he needs to fulfil his various roles including as Director of the Centre, Professor of Biomedical Circuits in the Department of Electrical and Electronic Engineering and CEO to Toumaz Ltd and DNA Electronics Ltd.



www.imperial.ac.uk/people/i.wojcicka

Izabela Wojcicka-Grzesiak

Senior Research Centre Administrator, Centre for Bio-Inspired Technology



www.imperial.ac.uk/people/joao.reis

Joao Reis

Project administrator (part time)

Iza is the group administrator for the Centre for Bio-Inspired Technology. She originally joined Imperial in 2006 as an administrator within the Institute of Biomedical Engineering and was appointed group administrator of the Centre in 2009 when it was formed.

Iza now plays a key role within the Centre supporting staff, students, research and facilities. Within her role she deals with all matters relating to finance, HR, health and safety and general administration.

Joao is the Project Administrator for the EPSRC project, 'Engineering, Physical, Natural Sciences and Medicine; Bridging Research in Antimicrobial Resistance; Collaboration and Exchange (EMBRACE)'. His role is to support the EMBRACE Fellows and multidisciplinary collaborations around antimicrobial resistance.



Mohammad Reza Bahmanyar, PhD

Research focus
Wireless Medical Implants and Devices

Funding
Wellcome Trust

MOTIVATION

Implantable medical devices play an important role in improving the quality of life of patients across the world. These devices are often the result of multi-disciplinary research, where different technologies are used and work together. Rapid advancement of technology in different areas and ever increasing need for new medical devices (e.g. due to the aging population) means that the future of healthcare will rely on efficient convergence of multiple disciplines. Understanding and utilizing science and technology in a creative way to develop novel medical devices that can potentially help patients is the main drive in my research.

OBJECTIVES

Measuring physical (e.g. pressure) and biochemical (e.g. glucose concentration) quantities inside the human body can assist in managing relevant medical conditions and assessing the efficiency of treatments. This requires biocompatible miniature implants of high longevity that can be interrogated wirelessly. Producing such devices is challenging and demands creative use of existing, and developing novel, technologies to achieve:

- Miniaturization without compromising the functionality.
- Increasing the longevity without compromising safety and biocompatibility.
- No cross-interference with other wireless systems.
- Devising ways of using the acquired data to maximize the benefit to the patient and minimize the cost to the healthcare system.

RECENT ACHIEVEMENTS:

- Implantable SAW Transponder for Acute and Chronic Blood Pressure Monitoring (as CoI). £2M funding secured from Wellcome Trust & DOH. Four patents were filed to protect the IP.
- Development of a novel prototype catheterised lithotripsy device for enhanced treatment of calcific coronary artery disease (as PI).
- A patent was filed to protect the IP. Funding secured (£15k) from the University of Leicester to continue the project funded by MRC (IC15).
- Micro Mems glaucoma pressure sensor (as PI). £25k is secured from Imperial Innovations to continue the project initially funded by Wellcome ISSF in 2013.

BIOGRAPHY

Dr Bahmanyar received his PhD from Brunel University in 2006. He has been doing research at the interface of engineering/physics with medicine for sixteen years developing medical devices including working with manufactures and regulators. He joined the Institute of Biomedical Engineering in 2009. Currently, he directs research on ocular implants and cardiovascular devices; also is part of a team, funded by the Wellcome Trust and the Department of Health to develop a complete implant system for a phase I clinical trial for pulmonary artery blood pressure monitoring. His research has attracted significant commercial interest from Imperial innovations and external investors.

PUBLICATIONS AND KEY REFERENCES

- S Lee, H Aguib, J Chapron, R Bahmanyar, A Borghi, O Murphy, Chris McLeod, A ElGuindy, M Yacoub, "Spatial Orientation and Morphology of the Pulmonary Artery: Relevance to Optimising Design and Positioning of a Continuous Pressure Monitoring Device", *J Cardiovasc Transl Res.* 2016 Jun;9(3):239–48, doi: 10.1007/s12265-016-9690-4.
- O H Murphy, A Borghi, M R Bahmanyar, C N McLeod, M Navaratnarajah, Mi Yacoub, C Toumazou, "RF communication with implantable wireless device: effects of beating heart on performance of miniature antenna"; *Healthcare Technology Letters*, Volume 1, Issue 2, June 2014, p. 51–55 DOI: 10.1049/htl.2014.0066 , Online ISSN 2053–3713.
- M Zolgharni, N MDhuria, G D Cole, M R Bahmanyar, S Jones, S M A Sohaib, S B Tai, K Willson, J A Finegold, D P Francis, "Automated Aortic Doppler Flow Tracing for Reproducible Research and Clinical Measurements," *Medical Imaging, IEEE Transactions on*, vol.33, no.5, pp.1071,1082, May 2014 doi: 10.1109/TMI.2014.2303782
- O H Murphy, M R Bahmanyar, A Borghi, C N McLeod, MNavaratnarajah, M H Yacoub, C Toumazou, "Continuous in vivo blood pressure measurements using a fully implantable wireless SAW sensor", *Biomedical Microdevices*, April 2013; DOI 10.1007/s10544-013-9759-7.

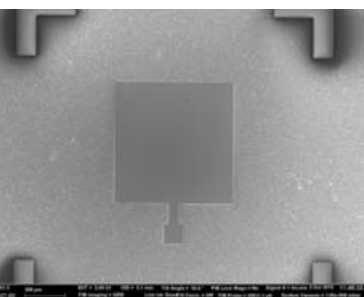

A film bulk acoustic wave resonator for IOP measurement



SAW pressure sensing implant for pulmonary artery



Nir Grossman, PhD

Research focus
Noninvasive Human Neuromodulation

Funding
Wellcome Trust MIT Postdoctoral Fellowship

MOTIVATION

Neuromodulation is widely used to study and treat the brain, presenting an attractive alternative for pharmacology treatment. Transcranial alternate current stimulation (TACS) is a new neural modulation method that uses weak, exogenous and periodic electric fields for synchronizing neural activity. TACS has been showing already very interesting neurobiological and behavioral effects despite a lack of exact understanding of the mechanism by which the mesoscopic neural oscillatory dynamics is modulated. The concept of remote modulation of the brain's oscillations - a hallmark of physiological and pathological functions, is very new and bears exciting engineering and clinical challenges and opportunities.

OBJECTIVE

- Develop mechanistic principles to achieve targeted and individualized noninvasive modulation of human brain oscillations.

RECENT ACHIEVEMENTS

- During the last 12 months, Nir and collaborators at MIT have completed first human testing of a novel brain stimulation technology, called temporal interference stimulation.
- In addition, in collaboration with UCLH, Nir have been employing a new method to explore how phase-locked brain stimulation can help suppress tremor activity in essential tremor patients.

BIOGRAPHY

Nir is a Wellcome Trust MIT Fellow with Prof. Chris Toumazou, working with Prof. Ed Boyden (MIT) and Prof. Alvaro Pascual-Leone (Harvard) on a neuromodulation technology that uses electric fields to entrain, non-invasively, oscillatory neural activity.

Nir has a PhD in Neuroscience from Imperial College London. In his PhD Nir and his co-workers, were developing a new type of retinal prosthesis that was based on a genetic expression of a microbial light sensitive ion channel. Nir has MSc in Electromagnetic Engineering from the Technical University of Hamburg-Harburg (TUHH), Germany and BSc in Physics from the Israeli Institute of Technology.

PUBLICATIONS AND KEY REFERENCES:

N Grossman, K Nikolic, C Toumazou, P Degenaar, "Modeling Study of the Light Stimulation of a Neuron Cell with Channelrhodopsin-2 Mutants", *IEEE Transactions on Biomedical Engineering*, vol. 58, no. 6, pp. 1742–51, 2011.

N Grossman, V Pohrer, M Grubb, G T Kennedy, K Nikolic, M A A Neil, M D Dawson, J Burrone, P Degenaar, "Multi-site optical excitation using ChR2 and micro-LED array", *J. Neural Eng.*, vol. 7, 2010.

P Degenaar, N Grossman, M A Memon, J Burrone, M Dawson, E Drakakis, M Neil, K Nikolic, "Optobionic vision – a new genetically enhanced light on retinal prosthesis", *J. Neural Eng.*, vol. 6, no. 3, 2009.

N Grossman, A Ovsianikov, A Petrov, M Eich, B Chichkov, "Investigation of optical properties of spiral photonic crystals", *Optic Express*, vol. 15, no. 20, pp. 13236–43, 2007.

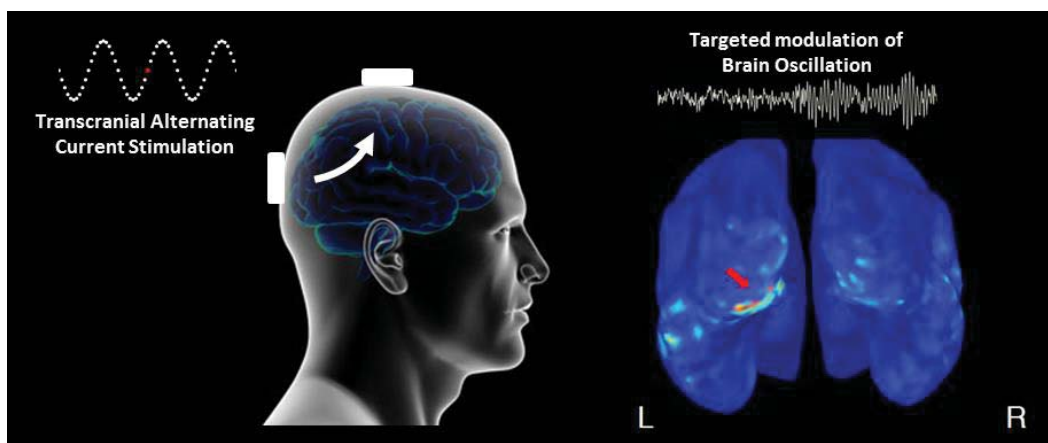



Pau Herrero-Viñas, PhD

Research focus
Developing control systems for medical applications

Funding
EPSRC

Intelligent point-of-care decision support system for antimicrobial prescribing



MOTIVATION

Around 385 million people throughout the world have diabetes. Optimal glucose management is crucial to reduce the risk of complications such as blindness, kidney disease and amputations. Recent advances in diabetes technology (e.g. continuous glucose sensors) and mobile technologies open the door to new treatments that can revolutionize diabetes management.

Antimicrobial resistance is now a major threat to patient safety and increasingly we are seeing patients infected with bacteria for which there are very few antimicrobials that remain effective. To conserve the effectiveness of antimicrobials we need to develop ways to use them more sensibly. New advances on clinical IT infrastructures (e.g. electronic health records) are allowing to collect and analyze big amounts of data in an unprecedented way. This technological revolution is facilitating the development of software tools to support clinicians to prescribe antibiotics in a more efficient way.

OBJECTIVES

- Clinical validation of a closed-loop system for automatic glucose control in diabetes (i.e. bio-inspired artificial pancreas).
- Development and clinical validation of a mobile decision support system for glucose management in diabetes.
- Development and clinical validation of a decision support system for optimizing antimicrobial therapy in secondary care.

RECENT ACHIEVEMENTS

- Development of a hybrid closed-loop controller for glucose management incorporating an adaptive meal-insulin bolus calculator (patent filed).
- Implementation of a novel bihormonal closed-loop control strategy inspired on the paracrine interaction between beta cell and alpha cell.
- Development of a safety system for a mobile-based decision support system in diabetes management.
- Designing a closed-loop controller for real-time antimicrobial delivery in a hospital setting (abstract accepted).
- Member of the organizing committee of the 1st ECAI Workshop on Artificial intelligence for Diabetes. 22nd European Conference on Artificial Intelligence (ECAI 2016). The Hague, The Netherlands, 2016.

BIOGRAPHY

Pau Herrero-Viñas received the MEng degree in industrial engineering from the University of Girona (Spain) in 2001, and the PhD degree in control engineering from University of Angers (France) in 2006. He then spent one year as a Research Fellow at University of California Santa Barbara (USA), working on an artificial pancreas project. After his stay in California, he spent two years at Sant Pau Hospital in Barcelona (Spain) leading different eHealth projects for the prevention and management of diabetes.

PUBLICATIONS AND KEY REFERENCES

M Reddy, P Pesl, M Xenou, C Toumazou, D Johnston, P Georgiou, P Herrero, N Oliver, "Clinical safety and feasibility of the Advanced Bolus Calculator for Type 1 Diabetes (ABC4D): a 6-week non-randomised pilot study" *Diabetes Technology and Therapeutics*, 2016, vol 18(8) pp. 487-493.

A Philip, P Herrero, "Closed-loop controller systems for the precision delivery of vancomycin: An in silico proof-of-concept", *FIS/HIS 2016 Conference*. Edinburgh, 2016.

P Herrero, J Bondia, P Pesl, N Oliver, P Georgiou, "Enhancing an Artificial Pancreas with an Adaptive Bolus Calculator based on Case-Based Reasoning. 1st ECAI Workshop on Artificial intelligence for Diabetes", *22nd European Conference on Artificial Intelligence (ECAI 2016)*. The Hague, The Netherlands, 2016.

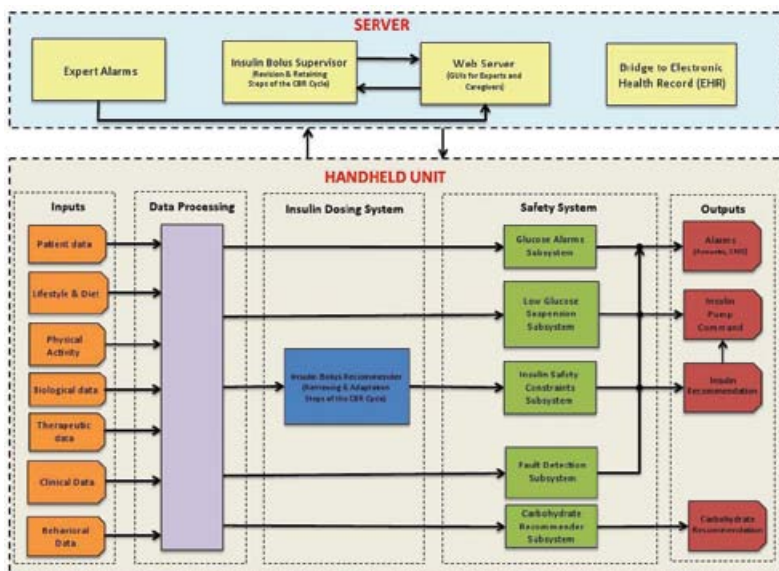



Nishanth Kulasekeram

Research focus

To develop low-power microelectronics for a fully implantable peripheral nerve interface for the monitoring and treatment of obesity

Funding

ERC Synergy (i2MOVE)

MOTIVATION

At this present day, there are key challenges that need to be addressed to design a fully implantable solution. The biggest and most important challenge is the ability to design a recording channel capable of amplifying bio potentials, ENG signals with CAP amplitudes of 15-80 μ Vp-p in a noise floor of 2.2-12.12 μ Vrms within a bandwidth of upto 10KHz. If the reader thought the above was challenging, we also need to detect neural mass activity which has amplitudes between 1-5 μ Vp-p, i.e. 151n- 751nVrms noise, which is below the noise floor of the front end amplifiers and associated sensor electrodes. Secondary level challenges are the power requirement of the complete solution needs to be kept down to a minimum, to extend the battery life for the implanted system.

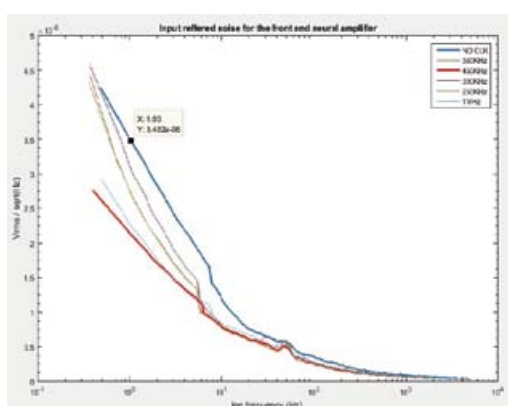

Figure 1. Measurement showing the input referred noise for the front end Neural Amplifier built into the recorder IC

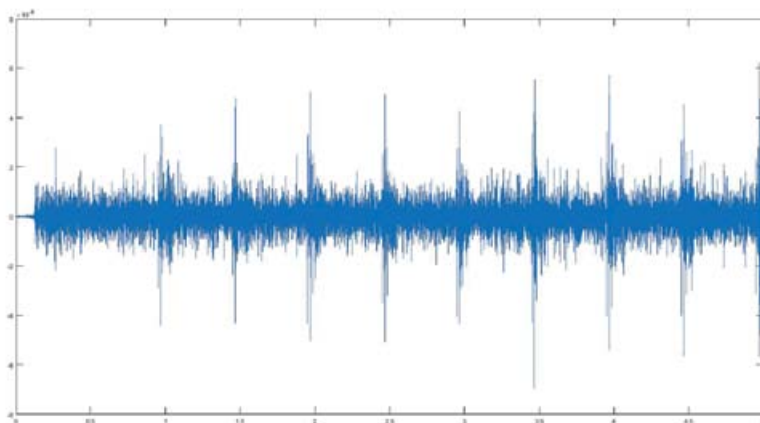

Figure 2. Shows the capture of Compound Action Potentials following a stimulation during an in vivo medical experiment using the recorder IC

OBJECTIVE

- To develop a multichannel recording and stimulating integrated solution, which has built-in intelligence by the end of 2017.

RECENT ACHIEVEMENT

To date most front end low noise amplifiers used within our single channel systems have noise optimized differential input stages that increases the physical dimensions of these OTAs. I have considered a technique to suppress the flicker noise contribution of individual mos transistors, thus reducing the physical dimensions (figure 1), and overall silicon area. figure-2, shows the capture of compound action potentials using front end amplifiers employing the flicker noise cancellation technique. My present research and achievements to date, have paved the way to producing a multi-channel IC shown in the picture below in figure-3.

BIOGRAPHY

I have spent 12 years in the semiconductor industry prior to joining the Centre of Bio Inspired Technology, here at Imperial College London, in July 2014. Over the past 2 years, since joining, I have developed integrated circuit solutions to aid the detection of CAPs, and mass activity off the sub diaphragmatic vagus nerve. The IC's, fabricated include a multi-channel electrical and PH recording solution. The designs also include a biphasic current stimulator integrated circuit to stimulate the cervical vagus.

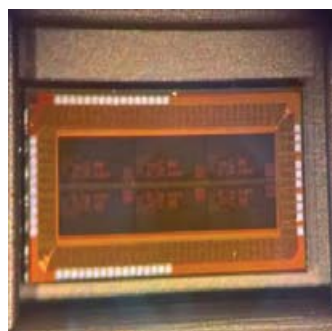

Figure 3. Integrated circuits with multiple electrical and PH channels developed for a multi-channel recording solution.



Yan Liu, PhD

Research focus

Integrated Neural Microsystems and Neural Interfaces

Funding

EPSRC (NS/A000026/1, EP/K015060/1) and Wellcome Trust CANDO

MOTIVATION

My work is in part motivated by the current quest to understand the human brain, developing new tools and applying these to create both next generation brain machine interfaces and therapeutic neural network regulation. Such devices will need to observe the activity of multiple neurons in real time, feedback to apply control mechanism with low latency, be chronically stable and be adaptive over time.

OBJECTIVES

- Design low power low noise highly intergrated circuits for neural interface
- Develop advanced data compression scheme for neural recording.
- Implement novel recording platform for either in-vivo or in-vitro study.

RECENT ACHIEVEMENTS

CANDO project is developing an optogenetically-enabled closed loop neural probe for regulating neural network activity, involving both neural recording and optical stimulation. My role on this is as a key contributor on the CMOS design of the neural probe itself and hardware system architecture. In such a

system, it is essential for the recording sub-systems to minimize the influence from stimulation and environmental interference, whilst also minimizing power consumption and silicon area utilization. Moreover, by improving the data and power interface of the entire system can positively impact encapsulation effort and realize long-term stability. The first version of the probe has been electrically tested and successfully verified experimentally. A second version of the probe has additionally been developed adding further functionality such as power/data management, reliability monitoring circuits, and improvements on the front-end interfaces.

In upscaling neural recording systems to high channel counts, we take a holistic approach, considering the system architecture as a whole, rather than simply scaling existing systems (more channels). One such system we have developed is a “smart” 64-channel recording system consisting of a bespoke in-channel DSP and memory to provide local processing (filtering, spike detection). With this system we have showed how both the power consumption and data bandwidth can be reduced without compromising the underlying performance. Moreover, digitally assisted calibration can be used to normalized certain non-linearity introduced by the constrained circuit size of the analogue blocks.

BIOGRAPHY

Yan Liu received the B.Eng degree in 2006 from Process Equipment and Control Engineering at Zhejiang University, China, the M.Sc degree in 2007 and Ph.D in 2012 from Electrical and Electronic Engineering at Imperial College London, UK. He is now a research associate in Centre of Bio-inspired technology, Electrical and Electronic Engineering at Imperial College London. His research area includes: CMOS based lab-on-chip devices and platforms, brain machine interface, and novel mixed signal circuits for biomedical applications.

PUBLICATIONS AND KEY REFERENCES

- Y Liu, J L Pereira, T G Constandinou, “Clockless Continuous-Time Neural Spike Sorting: Method, Implementation and Evaluation”, *ISCAS 2016*.
- S Luan, Y Liu, I Williams, T G Constandinou, “An Event-Driven SoC for Neural Recording”, *BioCAS 2016*.
- H Zhao, F Dehkoda, R Ramezani, D Sokolov, Y Liu, T Constandinou, P Degenaar, “A CMOS-based Neural Implantable Optrode for Optogenetic Stimulation and Electrical Recording”, *BioCAS 2015*.

(a) In-vivo test platform using Optrode version 1 chip.

b) measured results.

c) Fabricated Optrode version 3 chip

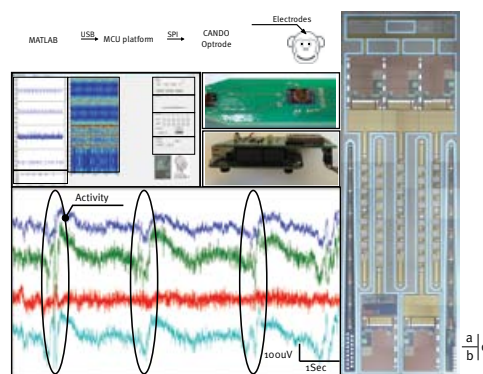

Smart recording chip version 2 design screen shot

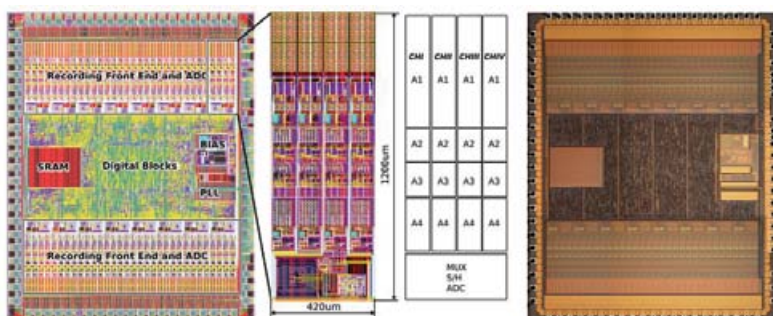



Jesus Rodriguez Manzano, PhD

Research focus

Engineering solutions for emerging infectious diseases and antimicrobial resistance

Funding

Wellcome Trust Networks of Excellence

MOTIVATION OF YOUR RESEARCH:

Emerging infectious diseases and antimicrobial resistance seriously endanger individual and global health, especially in developing countries. Worldwide monitoring is currently lacking and most of the analysis is limited to centralised laboratories, which are dispersed relative to the geographic spread of the population at risk. Current diagnostic tests require complex laboratory procedures and patients have to wait for days to receive the results, therefore it represents a major challenge for point-of-care diagnostics. My main goal here at CBIT is to develop simple diagnostic platforms for pathogen detection and typing that can be deployed in limited-resource settings and meet the WHO “ASSURED” criteria (see figure below).

OBJECTIVES

- Development and evaluation of simple lab-on-a-chip platforms for pathogen detection and typing that can be deployed in limited-resource setting.
- Development and evaluation of new pH-based molecular methods for SNP detection and pathogen identification, to be coupled with ISFET sensors.
- Development and evaluation of new isothermal amplification chemistries for ISFET sensing arrays in CMOS.

RECENT ACHIEVEMENT

The Engineering and Physical Sciences Research Council (EPSRC) has awarded the project “Engineering Rapid and Sensitive Electronic Diagnostics for Infectious Diseases (ERASED- ID)” from its Global Challenges Research Fund (GCRF). The aim of this proposal is to create a collaborative international network that will combine CMOS technology and biology for quantitative rapid, sample-to-answer tests able to diagnose emerging and re-emerging infectious diseases at the point-of-care. This project includes Brazil, Thailand and Vietnam, and focuses on Zika, chikungunya and malaria, particularly artemisinin resistant malaria.

BIOGRAPHY

After I finished my graduate studies in Microbiology, I enrolled for a Masters degree in Molecular Biology and completed a PhD in Environmental Microbiology and Biotechnology at the University of Barcelona, Spain. In 2012 I moved to the US for a short stay at the University of California, San Diego. Then, I joined the Division of Chemistry and Chemical Engineering at the California Institute of Technology for a three-year postdoctoral position, where I was developing cutting edge point-of-care diagnostic technologies for infectious diseases. My core expertise is situated within the interface of biology and engineering, including: bioinformatics, development of low-cost sample preparation methods, innovative molecular tools for detection, quantification and typing of microbial pathogens, microfluidics, isothermal nucleic acid amplification chemistries and digital single-molecule assays.

PUBLICATIONS AND KEY REFERENCES

J Rodriguez-Manzano, M A Karymov, S Begolo, D A Selck, D V Zhukov, E Jue, R F Ismagilov, “Reading Out Single-Molecule Digital RNA and DNA Isothermal Amplification in Nanoliter Volumes with Unmodified Camera Phones.” *ACS Nano*, 10, 3102–13, 2016.

B Sun, J Rodriguez-Manzano, D A Selck, E Khorosheva, M A Karymov, R F Ismagilov, “Measuring fate and rate of single-molecule competition of amplification and restriction digestion, and its use for rapid genotyping tested with hepatitis C viral RNA.” *Angew Chem Int Ed Engl*, 53, 8088–92, 2014.

D Witters, B Sun, S Begolo, J Rodriguez-Manzano, W Robles, R F Ismagilov, “Digital biology and chemistry.” *Lab Chip*, 14, 3225–32, 2014.

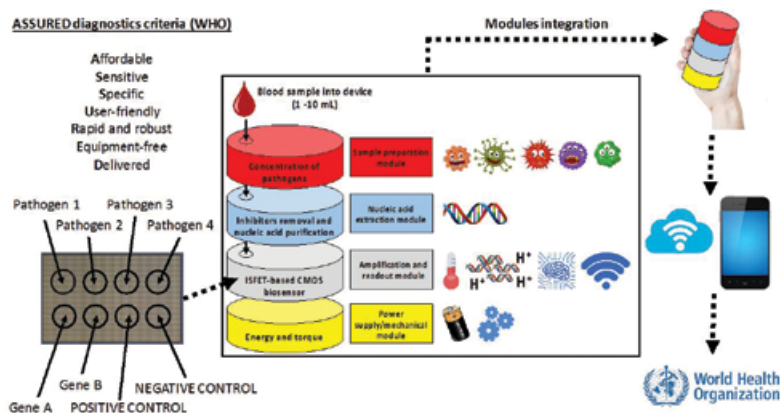



Nicoletta Nicolaou, PhD

Research focus

“AnaWARE”. Monitoring awareness during surgery: a multi-modal approach

Funding

EU FP7 Marie-Curie Intra-European Fellowship

MOTIVATION

Regaining consciousness during surgery is a rare, but traumatic event that could have long-term consequences (e.g. post-traumatic stress disorder). Available technology often lacks the capability of identifying the return of consciousness. An important reason for this is that we still do not understand how anesthetics exactly act. In order to improve current technology to alert, and even predict, the return of consciousness, we need to understand and study the changes to our body (brain, heart, respiration etc) caused by anesthetic administration. Only then can we utilize this information into a single index of anesthetic depth and improve anesthetic practice.

OBJECTIVES

- Understand how activity from different body systems interacts and how this interaction is affected by anesthetic administration.
- Understand how to link the observed changes to theoretical models of anesthetic effect on different

body systems and identify particular model parameters that could act as markers of returning consciousness.

- Develop an index that combines this information to monitor the underlying state of hypnosis.

RECENT ACHIEVEMENT :

A preliminary analysis of the data collected during the project, as well as additional data available from a collaborator, revealed: (i) changes in parameters of the cardiovascular system related to anesthetic administration, and (ii) complementary changes in the relationships between these parameters and brain activity. We expect that our recently developed method of nonlinear, nonparametric causality will provide an additional characterization of the observed changes from a causality point of view. Our findings support the motivation of developing a multi-modal index of anesthetic depth for monitoring purposes.

BIOGRAPHY

I recently completed a 2-year Marie-Curie Intra-European Fellowship (Grant no. 623767) at Imperial College London. Even though my background is a BSc and PhD in Cybernetics and Control Engineering (University of Reading – UK), I soon discovered a strong interest towards the fascinating aspects of the brain – one of the most complex biological control systems – and how our brain activity can be used to reveal the intrinsic mechanisms behind our conscious, and even unconscious, actions. My main research interests focus on changes in brain activity under anesthesia. I am currently a Research Fellow at the University of Reading, and an Honorary Research Fellow at Imperial College London.

PUBLICATIONS AND KEY REFERENCES

N Nicolaou, T Constandinou, “A Nonlinear Causality Estimator Based on Non-Parametric Multiplicative Regression”, *Frontiers in Neuroinformatics*, 10:19, 2016 (doi:10.3389/fninf.2016.00019)

N Nicolaou, J Georgiou, “Spatial Analytic Phase Difference of EEG activity during anesthetic-induced unconsciousness”, *Clin Neurophysiol*, 125(10):2122–31, 2014.

N Nicolaou, J Georgiou, “Global field synchrony during general anaesthesia”, *Br J Anaesth*, 112(3):529–39, 2014.

N Nicolaou, S Hourris, P Alexandrou, J Georgiou, “EEG-based automatic classification of ‘awake’ versus ‘anesthetized’ state in general anesthesia using Granger causality”, *PLoS One*, 7(3):e33869, 2012.

EEG activity during wakefulness (left) and anaesthesia (right)

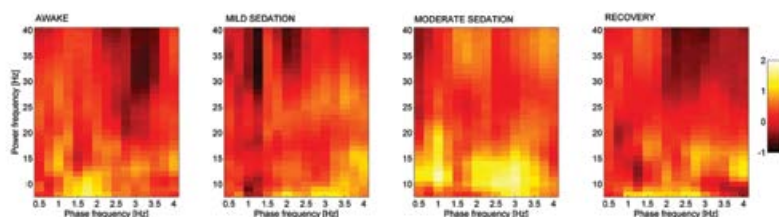
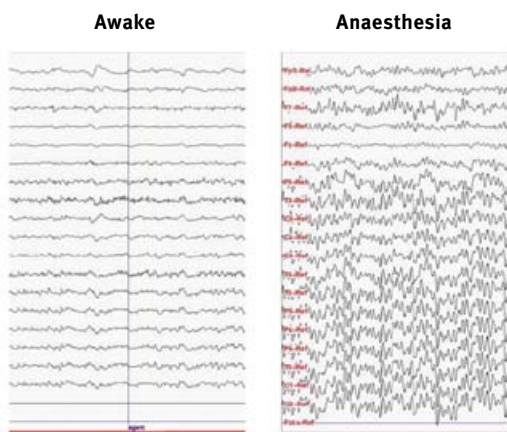

Changes in phase-amplitude coupling at a posterior brain area during wakefulness and anesthetic administration (sedation)



Nour Shublaq, DPhil

Research focus

Molecular diagnostics at the point of need and integrated bio-inspired solutions to tackle the greatest public health challenges

Funding

Winston Wong Centre for Bio-Inspired Technology

MOTIVATION

Bloodstream infections (BSIs) are a major cause of morbidity and mortality worldwide [1]. Early, effective antibiotic therapy is essential, but this need is confounded by the problem of slow time-to-result with current standard-of-care diagnostic tests as well as multidrug-resistant organisms. Patients typically receive empirical treatment with broad-spectrum agents, which are inadequate in up to 30% of cases, and physicians are faced with the dilemma of trying to restrict the routine use of third-line so-called reserve drugs versus the need to ensure early adequate coverage of potentially multidrug-resistant organisms. Rapid identification of BSI pathogens and resistance markers directly from clinical specimens would facilitate appropriate therapy to improve survival rates, reduce institutional costs, and stem the tide of antimicrobial resistant organisms [2].

Obesity is one of the greatest public health challenges of the 21st century. Affecting over half a billion people worldwide, it increases the risk of stroke, ischaemic heart disease, diabetes, many cancers and depression. Bariatric surgery is currently the only effective treatment available but is associated with significant risks of perioperative mortality and long-term complications. The ERC i2MOVE consortium proposes to use obesity as a paradigm for development of, and for the first time, a new generation of neural interface that combines novel electrode materials, structures and sensing modalities with ultra-low power electronic neural recording, analysis, stimulation [3] and wireless communication.

OBJECTIVES

My objectives are wide ranging but mainly concentrate on leadership to raise the profile of Imperial College at the national and international stage, and make a measurable difference at the frontline, through:

- Major research initiatives in the areas of infectious disease and antimicrobial resistance, as well as control of satiety
- Impactful output, new collaborations and partnerships
- Very large fundraising including key interactions with industrial partners.

SELECTED RECENT ACHIEVEMENTS:

- Taken responsibility from March 2016 over €7million ERC i2MOVE project as lead and Imperial point of

contact with the funder. Lead to completion the technical and financial reporting, value €1.81 million.

- Successfully coordinated and won in September 2016 a sizeable grant worth \$52million, what could be one of the biggest UK grants, to develop DNA sequencing platform for rapid diagnosis of antimicrobial resistant infections and influenza.
- Act as the voice of exploitation for £700,000 NIHR i4i EPIC IMPOC project, which aims to integrate all necessary information (patient data, lab data, local guidelines etc.) required by healthcare professionals to make correct prescribing decisions and be accessible at the bedside.

BIOGRAPHY

Since February 2014, Nour provides technical knowledge and expertise in business organisation and development towards successful translation of CBIT activities in close collaboration with Imperial Spinouts – particularly in the areas of AMR, Cancer, and recreational consumer electronics. Prior to joining Imperial College, she served as ‘Senior Research Associate’ at University College London (UCL) with responsibility to coordinate and drive major R&D initiatives in the Computational Life and Medical Sciences Domain at UCL, UCL Partners (16 UK NHS Trusts) and beyond, via competitive proposals; act as the industry point-of-act; and serving on committees to inform the direction of e-infrastructure policy at UK and EU level. Nour is an Electrical Engineer with an M.Sc. (2007) and a D.Phil. (2011) in Biomedical Engineering from the University of Oxford.

PUBLICATIONS AND KEY REFERENCES

J Cohen, *et al.* “Sepsis: a roadmap for future research”. *Lancet Infect Dis*, 15, p. 581–614, May 2015.

C J McElgunn, L-J Clarizia, R Weerathunga, R Bauer, A Barr, C Icely, N Brown, N Casali, K Amin-Desai, Z Ansari, P Athanasiou, M Baeza, V Balakrishna, S Bone, D Boyd, M Davila, D Garcia, D Garner, J Lujan, M Norvell, T C Papageorgiou, A Patel, S Pradhan, A Ramesh, R Sahoo, N Shublaq *et al.* “Rapid, sensitive detection of clinical bloodstream infections directly from whole human blood”. *Conference proceedings of the American Association of Pathology (AMP)*, 2016 (in press).

V Valnte, A Demosthenous *et al.* “Design of a current-steering implantable stimulator with electric field shifting for deep brain stimulation”. *Conference proceedings of IEEE Int. Symp. Circuits and Systems (ISCAS)*, 2010, pp. 162–165.



Laszlo Grand, PhD

Research focus

Neural interface technologies for in-vivo and *in-vitro* applications

Funding

EPSRC ENGIN1 (EP/M020975/1)

MOTIVATION

I feel motivated to develop novel technologies for in-vivo and in-vitro applications and pave the way of inventions towards industrial applications. Recently I am initiating two research projects. The first aims to develop an implantable, miniature low-energy consumption chip for recording motor cortical EEG activities, calculating the actual Phase Amplitude score, then selectively stimulating the target deep brain structure for suppressing parkinsonian symptoms with a closed loop application. The second aims to develop an integrated solution for continuous recording of neurophysiological and chemical activities of thousands of neurons in-vitro with high density multi-well plates in parallel, carrying out real-time spike sorting, adaptively identifying patterns in recorded neural circuit activities and providing statistical measures of neural culture activities.

OBJECTIVES

- To exploit the full potential of research results of the Next Generation Neural Interface Group (NGNI)
- To develop devices that interface with neural pathways and neural cell cultures.
- To successfully develop funding bids and realize my research goals

RECENT ACHIEVEMENTS

Since joining to the NGNI group as a Research Officer in July 2016 I have initiated collaborations for developing new projects with GlaxoSmithKline, Dr. Mark Ungless (in-vivo neurophysiology, ICL), Dr. TK Kozai (Univ. of Pittsburg, bio fouling), Dr. Zoltan Mari (Johns Hopkins University, neurologist) and actively searching scientist partners for in-vitro neurophysiology focused projects. Securing grant resources is an important part of my work. So far I have contributed to writing 3 EU grant proposals, 2 EPSRC proposals and 1 Impact Accelerator Account proposal (ICL). Currently I am developing new research project proposals and trying to recruit MSc students, which I hope will lead to new grant proposals.

For expanding the visibility of our group I have co-organized the neural interfaces section of the

BrainCAS workshop in Hangzhou (between 19-21 October, 2016). Additionally, I co-initiated and managing the X-CBIT project, which aim is to design a show room for exhibiting the research products of the Centre for Bio-Inspired Technology.

BIOGRAPHY

I received my MSc degree in Computer and Electrical Engineering from the Pázmány Péter University in Hungary in 2006 and my PhD in Neuroscience from the same University in 2010. My PhD thesis focused on development and characterization of a novel implantable neural probes for in-vivo research, which I partly carried out at the University of Michigan and NeuroNexus Technologies. As a postdoctoral fellow of the Laval University in Canada I performed traumatic brain injury related neurophysiological studies between 2010-2012 before becoming the R&D director of a US based company, which focus is implantable neural interfacing technologies. I joined to the Johns Hopkins University as an Investigator in 2013, where I carried out in-vivo and in-vitro neurophysiological studies on neural circuit development and designed assays for drug testing for pharmaceutical companies.

PUBLICATIONS AND KEY REFERENCES

- I Timofeev, T J Sejnowski, M Bazhenov, S Chauvette, L Grand, "Age dependency of trauma-induced neocortical epileptogenesis", *Frontiers in Cellular Neuroscience*, vol 7, pp. 154–164, 2013.
- L Grand, S Ftomov, I Timofeev, "Long-term synchronized electrophysiological and behavioral wireless monitoring of freely moving animals." *Journal of Neuroscience Methods*, vol 212, no. 2, pp. 237–41, 2013.
- L Grand, A Pongracz, E Vazsonyi, G Marton, D Guban, G Karmos, I Ulbert, G Battistig. "A novel multisite silicon probe for high quality laminar neural recordings", *Sensors and Actuators A-Physics*, vol 166, no. 1, pp.14–21, 2011.
- L Grand, L Wittner, S Herwik, E Gothelid, P Ruther, S Oscarsson, H P Neves, B Dombovari, R Csercsa, G Karmos, I Ulbert, "Short and long term biocompatibility of NeuroProbes silicon multielectrodes." *Journal of Neuroscience Methods*, vol. 189, no. 2, pp. 216–29, 2010.



Deren Barsakcioglu, PhD

Research focus

Adaptive real-time scalable neural signal processing

Funding

EPSRC Prize Doctoral Fellowship

MOTIVATION

Electrode-tissue interface is a highly dynamic environment due to various factors. These include foreign body reaction (immune response) which results in encapsulation and material degradation of the electrode tip, and micromotion of the electrodes. These result in changes in the observed neural recording signals over long term, hence developing adaptive neural signal processing algorithms is essential for chronically monitoring neuronal populations.

In line with this, my research focuses on developing such adaptive algorithms for scalable real-time chronic neural signal processing. Moreover, my research also involves modelling of the long-term changes observed in neural signals which is critical in our efforts to develop such adaptive algorithms for chronic use.

OBJECTIVES

- Modelling chronic changes observed in long term (≥1 month) neural recordings.
- Developing adaptive real-time spike detection and sorting algorithms for chronic implants

BIOGRAPHY

Dr Deren Barsakcioglu is a research associate in the Next Generation Neural Interfaces (NGNI) research group within Imperial's Centre for Bio-Inspired

Technology. Following a B.Sc. degree in Electrical and Computer Engineering from University of Texas at Austin in 2010, Dr Barsakcioglu received M.Sc. and PhD degrees from Imperial College London in 2011 and 2016, respectively. Following his PhD, he has been awarded the EPSRC Postdoctoral Prize fellowship. His main research interests include neural recording, biomedical signal processing, and machine learning.

PUBLICATIONS AND KEY REFERENCES

DY Barsakcioglu, TG Constandinou, "A 32-Channel MCU-based feature extraction and classification for scalable on-node spike sorting", *In Proc. IEEE Int. Symposium on Circuits & Systems (ISCAS)*, pp. 1310–1313, 2016.

DY Barsakcioglu, Y Liu, P Bhunjun, J Navajas, A Eftekhar, A Jackson, RQ Quiroga, TG Constandinou, "An Analogue Front-End Model for Developing Neural Spike Sorting Systems", *IEEE Transactions on Biomedical Circuits & Systems*, vol. 8, no. 2, pp. 216–227, 2014.

J Navajas, DY Barsakcioglu, A Eftekhar, A Jackson, TG Constandinou, RQ Quiroga, (2014). Minimum requirements for accurate and efficient real-time on-chip spike sorting. *Journal of neuroscience methods*, vol. 230, pp. 51–64, 2014.

DY Barsakcioglu, A Eftekhar, TG Constandinou, "Design optimisation of front-end neural interfaces for spike sorting systems", *In Proc. IEEE Int. Symposium on Circuits & Systems (ISCAS)*, pp. 2501–2504, 2013. (Best Paper Award)

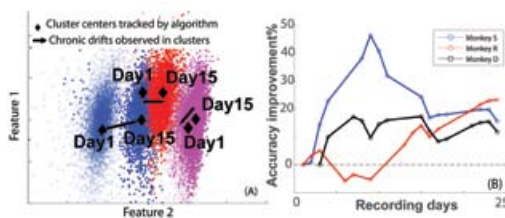

Figure 1. Artificial neural network based adaptive spike sorting. (A) Chronic drifts observed real extracellular recordings, and (B) average performance improvement compared to non-adaptive sorting. (In collaboration with Michigan State University)

Figure 2. Artificial neural network based autonomous (i.e. self-calibrating) spike detection algorithm for large scale neural monitoring systems adapting to various signal conditions.

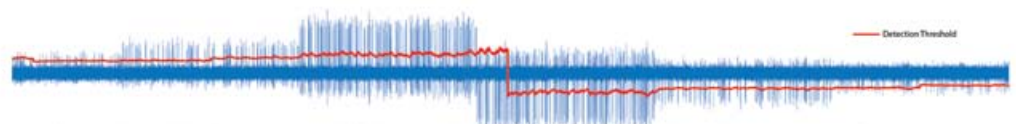

Figure 3. Analysis and modelling of chronic neural recordings.



Benjamin Evans, DPhil

Research focus
Modelling and analysis of biomedical data

Funding
EPSRC

MOTIVATION

Optogenetics is a powerful technique for modulating the responses of neurons through genetically inserting photosensitive ion channels. This method has been widely applied from neuroscience to cardiology for investigating normal function and treating disorders. The ability to computationally characterise the photocurrent arising from optical stimulation of these proteins (opsins) and predict their effect on individual or networks of transfected cells would greatly enhance the effectiveness of optogenetics as a tool for transforming the biological and medical sciences.

I currently work on several projects applying machine learning to biomedical data to build classifiers for diagnostic inference. These projects aim to reduce the number of invasive diagnostic procedures and misuse of antibiotics while maintaining clinically significant detection rates.

OBJECTIVES

- Gain insights into neural and biomedical systems from data
- Develop models and tools to guide theory and experiments
- Enhance the research's impact through open science practices

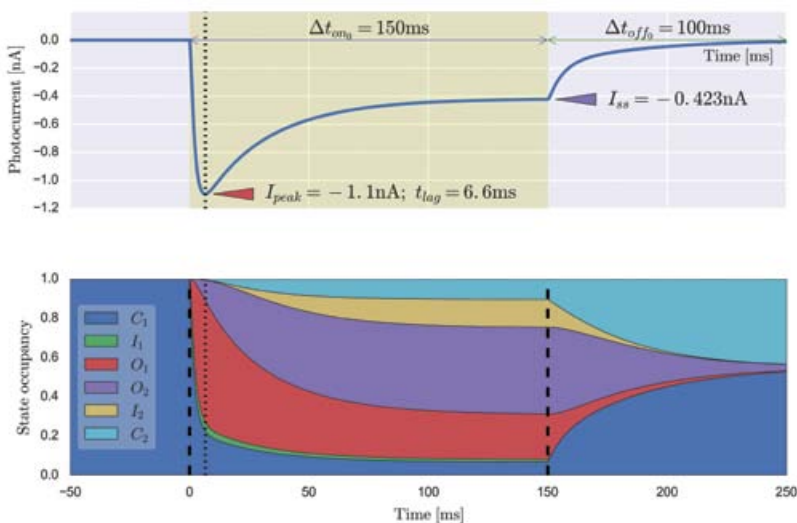

RECENT ACHIEVEMENT

Research on the functional behavior of opsins culminated in the open-source module PyRhO and an accompanying paper. Alongside other related projects, development of PyRhO has continued and is now available as a web portal to instantly try it in a browser without any installation necessary (**try.projectpyrho.org**). The work has been presented at three conferences and the accompanying code was published in the project repository on GitHub.

BIOGRAPHY

I am interested in many areas of science and have enjoyed an unusually multi-disciplinary background, including degrees in Experimental Psychology, Intelligent Systems and a DPhil in Computational Neuroscience. Prior to joining Imperial, I built self-organising spiking neural networks to model the learning processes of object recognition in the ventral visual system. Having spent my doctorate reverse engineering part of the brain, moving from a psychology to an engineering department was a more natural step than it may at first seem. Besides computational modelling, I am also interested in neuromorphic hardware, machine learning, bouldering, playing the guitar and Jack Russell Terriers.

PUBLICATIONS AND KEY REFERENCES

BD Evans, K Nikolic, "From bytes to insights with modelling as a service: A new paradigm for computational modelling illustrated with PyRhO", In Biomedical Circuits and Systems Conference (BioCAS), 2016 IEEE, Shanghai, China, 2016.

J Luo, K Nikolic, B Evans, N Dong, X Sun, P Andras, A Yakovlev, P Degenaar, "Optogenetics in silicon: A neural processor for predicting optically active neural networks" *IEEE Transactions on Biomedical Circuits and Systems*, 2016. doi:10.1109/TBCAS.2016.2571339.

K Nikolic, B D Evans, "Identifying optimal feature transforms for classification and prediction in biological systems: Recovering receptive field vectors from sparse recordings", In *ICML 2016 Workshop on Computational Biology*, New York, NY, 2016.

B D Evans, S Jarvis, SR Schultz, K Nikolic "PyRhO: A multiscale optogenetics simulation platform". *Frontiers in Neuroinformatics*, vol. 10 no. 8, 2016. doi:10.3389/fninf.2016.00008.



Sara S Ghoreishizadeh, PhD

Research focus

Integrated system, circuit, and sensor design in CMOS technology for implantable and point-of-care medical devices (I&P-MD)

Funding

Imperial College Research Fellowship

MOTIVATION

The Lab-on-CMOS (LoC) method has recently emerged to enable cheap and disposable diagnostics for metabolic diseases such as Diabetes. LoC requires devices that fully integrate a number of miniaturized sensors in CMOS technology together with the circuit. Key challenges are developing such sensors with high sensitivity, long life-time, and less calibration steps.

IMDs typically employ transcutaneous telemetries to transmit power and data, thus avoiding the risk of infection due to breaching the skin barrier. The implanted devices however use wired connections between multi-module implants. A key challenge here is reliable transmission of data/power through the wire while ensuring its mechanical reliability.

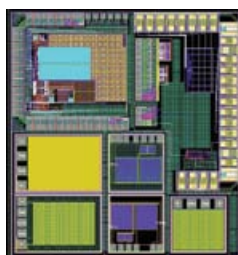

Layout of (1.4x1.4mm) IC which enables a wired power/data communication scheme between multiple implantable medical devices (IMD)

OBJECTIVES

- Develop system and circuits for implantable medical devices (IMD), in particular, low power CMOS circuits for:
 - Amperometric miniaturized sensor readout
 - Power and data management
 - IMD automation
- Develop novel methods and algorithms to auto-calibration metabolite sensor
- Develop methods and protocols for reliable integration of sensors with CMOS technology

RECENT ACHIEVEMENTS

- I developed and successfully tested on-chip sensors for glucose detection, in collaboration with EPFL. I further developed a system on CMOS technology (towards LoC) for metabolite detection (tapeout June 2016), where I designed novel circuits to allow differential sensing as well as environmental calibration with pH and temperature.
- I designed a full system-on-CMOS for wired power/data communication between IMDs (tapeout June 2016). Here, I designed an innovative system for on-chip ID-generation for a multi-IMD system.
- A new insight about auto-calibration of glucose sensors has been achieved, through the MSc project of Mr Xiaotian Zhang (Co-supervised by me).

BIOGRAPHY

I received BSc degree in Electrical Engineering and MSc degree in Microelectronics from Sharif University of Technology, Iran, in 2007 and 2009, respectively. I

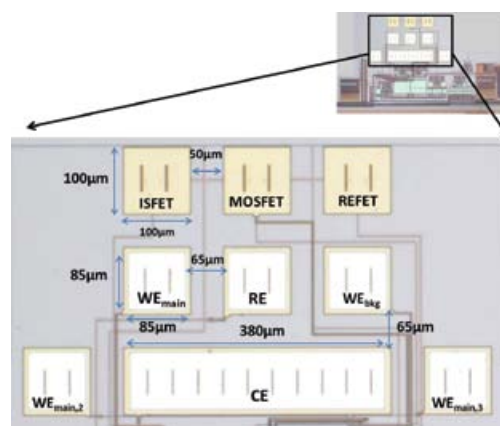

Layout of an IC with on-chip electrodes for electrochemical sensing of metabolite

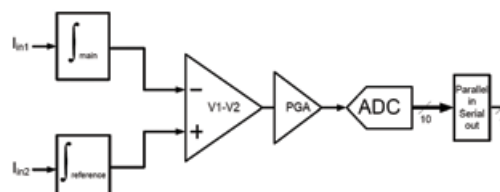

Differential readout circuit architecture

joined the integrated systems Laboratory (LSI) at EPFL, Switzerland in 2010 as a research assistant, where I obtained a PhD in 2015. My PhD thesis was focused on designing dedicated integrated circuits (ICs) for health-care monitoring and personalized-therapy within highly-integrated implantable medical devices (IMD). I joined the Neural Interfaces group, Centre for Bio-inspired Technology (CBIT) in April 2015 as a post-doctoral Research Associate and since December 2015 I am a Junior Research Fellow at CBIT.

PUBLICATIONS AND KEY REFERENCES

- S S Ghoreishizadeh, P Georgiou, S Carrara, G De Micheli, "An integrated platform for differential electrochemical and ISFET sensing," 2016 *IEEE International Symposium on Circuits and Systems (ISCAS)*, Montreal, QC, 2016, pp. 2875–2878.
- C Baj-Rossi, S Ghoreishizadeh, G De Micheli, S Carrara, "An Innovative System of Membranes for the Monitoring of Endogenous and Exogenous Metabolites", *Bionanoscience*, Vol. 6, No. 2, pp 85–92, 2016
- E G Kilinc, C Baj-Rossi, S S Ghoreishizadeh, S Riario, F Stradolini, C Boero, G De Micheli, F Maloberti, S Carrara, C Dehollain, "A System for Wireless Power Transfer and Data Communication of Long-Term Bio-Monitoring," in *IEEE Sensors Journal*, vol. 15, no. 11, pp. 6559–6569, Nov. 2015.



Melpomeni Kalofonou, PhD

Research focus

Semiconductor technologies for early detection and monitoring of cancer

Funding

EPSRC

MOTIVATION

Cancer is undoubtedly among the leading causes of mortality worldwide, with the development of new methods for early detection and risk stratification to be at the forefront of cancer research, with one common aim, the personalisation of treatments that could prolong survival and the precise monitoring of progression to achieve early detection and minimise the risk of relapse.

In specific, common types of cancer such as breast cancer (lifetime risk of 1 in 8 women and more than 25% of treated cases to develop a metastasis) could considerably benefit from a reshaped model of screening, by monitoring genetic and epigenetic changes that could reflect the original tumour and predict signs of minimal residual disease, even of a potential resistance to treatment. My research focuses on the development of semiconductor based Lab-on-Chip platforms for detection of these changes using CMOS integrated chemical sensors (ISFETs), the sensing elements of CBIT's microchip based Lab-on-Chip systems.

OBJECTIVES

- Development and experimental validation of microchip based DNA detection platforms for breast cancer specific markers.
- Integration and miniaturization of Lab-on-Chip sensing technology for monitoring of circulating markers in blood (eg. circulating tumour-derived DNA).
- The integration of pre-amplification and analyte-isolation steps in a fully autonomous system for breast cancer risk stratification and initiation of pilot clinical validation studies.

RECENT ACHIEVEMENT

Some highlights of the last year include initial validation of breast cancer markers using our ISFET based microchip platforms in collaboration with Prof.

Charles Coombes, Dept. of Surgery and Cancer, Imperial College London and Prof. Jacqui Shaw, Dept. of Cancer Studies, University of Leicester, presentation of our work on 'Epigenetic-IC: A fully integrated sensing platform for epigenetic reaction monitoring' at the IEEE ISCAS 2016, Montreal, Canada, giving a guest lecture at the Circulating Cancer Markers workshop organized by the Cancer Research UK Imperial Centre, on 'Microchip sensing technology for detection of circulating breast cancer markers' and being elected to serve on the IEEE Biomedical Circuits and Systems Technical committee.

BIOGRAPHY

Melpomeni received the Dipl.-Eng. degree in Electrical and Computer Engineering in 2007 from the University of Patras, Greece followed by an MSc in Biomedical Engineering in 2009 and a PhD in 2013 from Imperial College London. Her PhD focused on the application of semiconductor technology in detection of cancer epigenetic biomarkers using ISFETs integrated with current-mode circuits to form Lab-on-Chip diagnostic platforms leading to the demonstration of the first method for real-time amplification and detection of DNA methylation. She continued on to become a Postdoctoral Researcher and lead of the Centre's Cancer Technology research theme. Her current research focuses on the detection of genetic and epigenetic markers for breast cancer in addition to the detection of isothermal DNA amplification chemistries using fully integrated systems.

PUBLICATIONS AND KEY REFERENCES

A Koutsos, M Kalofonou, M Sohbaty, C Toumazou, "Epigenetic-IC: A fully integrated sensing platform for epigenetic reaction monitoring," *IEEE International Symposium on Circuits and Systems (ISCAS)*, pp. 325–328, 2016.

M Kalofonou, C Toumazou, "An ISFET based analogue ratiometric method for DNA methylation detection," *IEEE International Symposium on Circuits and Systems (ISCAS)*, pp. 1832–1835, 2014.

M Kalofonou, C Toumazou, "A low power sub- μ W Chemical Gilbert Cell for ISFET differential reaction monitoring," *IEEE Transactions on Biomedical Circuits and Systems (TBCAS)*, 2013, vol. 8, no. 4, pp. 565–574, 2013.

M Kalofonou, C Toumazou, "Semiconductor technology for early detection of DNA methylation for cancer: From concept to practice," *Sensors and Actuators B: Chemical*, vol. 178, pp. 572–580, 2013.

Detection of cell-free DNA markers for breast cancer using microchip technology

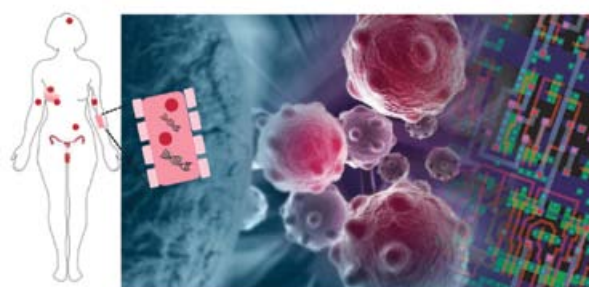



Dr Sara de Mateo Lopez

Research focus

Integration of isothermal nucleic acid amplification chemistries with ISFET-based pH measurement in CMOS technology for epigenetic marks analysis.

Funding
EPSRC

MOTIVATION

The need of rapid analysis of nucleic acids linked to non-optical readout methods has grown lately. The use of complementary metal-oxide semiconductors (CMOS) integrated with ion-sensitive field effect transistor (ISFET) sensors have been already proved to be successful at discriminating single nucleotide polymorphisms through isothermal amplification at real time. During nucleic acid amplification there is an inherent production of protons by DNA polymerases with the consequently drop in pH. Hence, the developed chip integrates real time, label-free amplification and detection of nucleic acids using pH-sensing CMOS technology through ISFET sensors. Of importance, this semiconductor technology has also been demonstrated for real-time detection of DNA methylation. The chip has all the necessary components for nucleic acid amplification and detection to create a full lab-on-chip platform to enable the development of point-of-care diagnostic devices.

OBJECTIVES

My short-term and long-term objectives are:

- Test new isothermal nucleic acid chemistries in chips that integrate a major number of ISFET sensors and eventually help create a lab-on-chip platform that will be used as a diagnostic tool for point-of care.
- Integrate my background in human fertility with the technology available in the department for the development of a lab-on-chip approach to detect epigenetic traits (DNA methylation) of human sperm samples. Aberrant sperm DNA methylation has already been demonstrated to be associated with human male infertility.
- Select a panel of genes whose epigenetic signature correlate with sperm quality and fertilization success.

RECENT ACHIEVEMENT

I just started my research position in this department after a two years break and I am eager to perform high

quality research using the technology developed in the department.

BIOGRAPHY

As a PhD student in the University of Barcelona (Spain) I focused my research in the identification of molecular markers for human male infertility. I performed this goal through the description of the proteomic profile of the whole as well as the nucleus of human sperm samples from patients and controls. I also characterized the chromatin maturity of human spermatozoa from samples that were selected through density gradient. After I finished my PhD I moved to California to start a Postdoctoral position in the University of California, Irvine (USA) where I studied the mouse sperm metabolism and functionality along the circadian cycle. After a short break of two years I now have just started a research position at the EEE department.

PUBLICATIONS AND KEY REFERENCES

C Toumazou, L M Shepherd, S C Reed, G I Chen, A Patel, D M Garner, C J Wang, C P Ou, K Amin-Desai, P Athanasiou, H Bai, I M Brizido, B Caldwell, D Coomber-Alford, P Georgiou, K S Jordan, J C Joyce, M La Mura, D Morley, S Sathyavvruthan, S. Temelso, R E Thomas, L Zhang, "Simultaneous DNA amplification and detection using a pH-sensing semiconductor system", *Nature Methods*, vol. 10(7):641–646, 2013.

M Kalofonou, C Toumazou, "Semiconductor technology for early detection of DNA methylation for cancer: From concept to practice", *Sensors and Actuators B: Chemical*, vol. 178, 572–580, 2013.

S de Mateo, P Sassone-Corsi, "Regulation of spermatogenesis by non-coding RNAs", *Seminars in Cell and Developmental Biology*, vol. 29:84–92, 2014.

K L Eckel-Mahan, V R Patel, S de Mateo, R Orozco-Solis, N L Ceglia, S Sahar, S A Dilag-Penilla, K A Dyar, P Baldi, P Sassone-Corsi, "Reprogramming of the Circadian Clock by Nutritional Challenge", *Cell*, vol. 155(7):1464–1478, 2013.

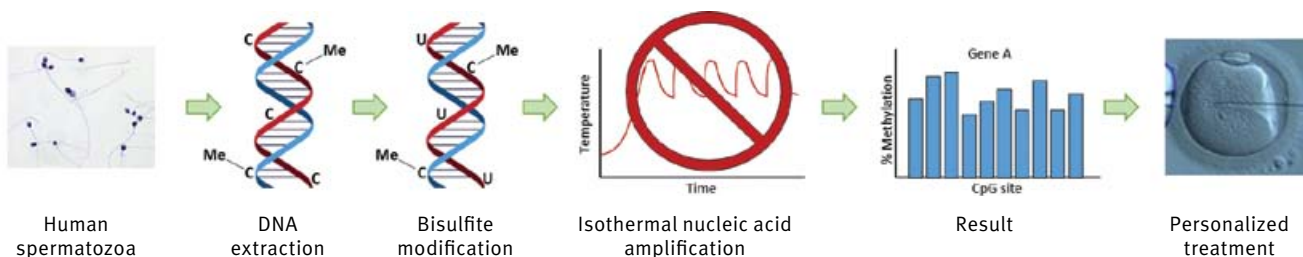



Song Luan, PhD

Research focus

Integrated neural microsystems and neural interfaces

Funding

EPSRC iPROBE (EP/K015060/1) and Impact Accelerator Account

MOTIVATION

As electronic systems keep shrinking in size and improving in functionality, more and more applications are now focusing on vital sign monitoring. E.g. heart rate, blood pressure, etc. There is currently a tremendous drive to develop new enabling technologies for neuroscience. This will pave the way to a new breed of neural interfaces and prosthetic devices that will restore natural function. The underlying, ultimate motivation is however to improve the quality of life of individuals with neural damage and dysfunction.

OBJECTIVES

To make a successful neural interface requires collaboration between the biosciences and engineering. My key objectives are predominantly engineering focused: to make devices more compact (particularly for implantables, wearables), versatile and energy efficient (battery lifetime, improving biocompatibility due to dissipation). The main projects I am involved aim to:

- Build a scalable miniature system that is capable of real-time hardware spike sorting thus reducing data-rate reduction for wireless communication and other real-time applications;
- Record at least 1k channels of neural signals at different areas of brain to allow investigation of neural circuitry.
- Provide chronic *in-vivo* recording solutions for laboratories.

RECENT ACHIEVEMENT

The NGNI neural recording system has been substantially upgraded from the version developed in 2015. Significant reductions in both size and weight have been made together with additional functionality including: automated data logging and wireless data

transmission. Following the successful demonstration in IEEE BioCAS 2015 and FENS (Forum of Neuroscience) 2016, the system is due to be evaluated by collaboration neuroscience labs in Q4 2016. A novel recording chip has been fabricated to further lower the system power consumption without sacrificing any functionality paving the way into more exciting developments in 2017.

BIOGRAPHY

Song Luan received the MSc in analogue and digital integrated circuit design and PhD degrees in biomedical microelectronics engineering from Imperial College London in 2010 and 2014 respectively. Since 2014, he works as a research associate in the Next Generation Neural Interfaces Lab. He has designed different types of integrated neural stimulation circuits and systems with 0.35 and 0.18 micron processes. He is also an advanced engineer in PCB, firmware and software development for in-house custom hardware. His main research interests include neural interfaces and its applications, low power microelectronics and wireless power/data link.

PUBLICATIONS AND KEY REFERENCES

S Luan, Y Liu, I Williams, TG Constandinou, "An Event-Driven SoC for Neural Recording", *Proc. IEEE Biomedical Circuits & Systems (BioCAS) Conference*, pp. 404–407, 2016.

I Williams, A Rapeaux, Y Liu, S Luan, TG Constandinou, "A 32-Channel Bidirectional Neural/EMG Interface with on-Chip Spike Detection for Sensorimotor Feedback" *Proc. IEEE Biomedical Circuits and Systems (BioCAS) Conference*, pp. 528–531, 2016.

S Luan, I Williams, F de Carvalho, A Jackson, R Quian Quiroga, TG Constandinou, "Next Generation Neural Interfaces for low-power multichannel spike sorting", *FENS Forum of Neuroscience*, 2016.



System outputs of recorded neural signal with annotated spike events in real-time. (Different cross colour identify spikes recognised as from different neurons.)

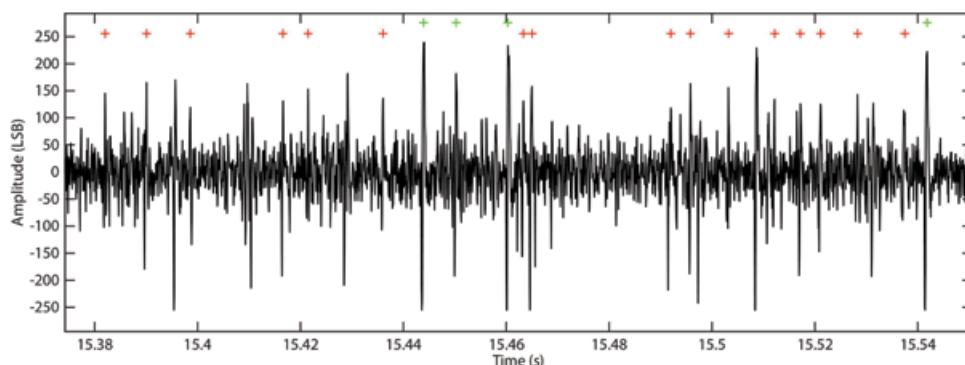



Mohammadreza Sohbati, PhD

Research focus

Semiconductor-based DNA Sequencing and Genotyping

Funding

EPSRC

MOTIVATION

Technology has empowered us to understand more about us and the nature around us. It has been a promising in dealing with many challenges in the world. On life sciences in particular, we experienced a fruitful ride from developing devices for diagnosis, point-of-care and mobile monitoring, prevention, and prediction. We expanded the depth and breadth of our research especially by two major initiatives: human genome project and brain map project. Now it is time for integration and investigation in a new layer, to see impact in our day-to-day lifestyle. Please see our featured research page on nudgeomics.

OBJECTIVES

- Development of nudgeomics concept (please read featured research page)
- Applying technology (in particular genetic technology) for lifestyle and behavior change
- Developing technology for biomolecular analysis

RECENT ACHIEVEMENT

Over the last twelve months, part of my focus was on understanding and simulating kinetics of DNA amplification monitoring using pH change as an indicator. I have also been studying on alternative technologies which may act as non-invasive methods for early detection and stratification of disease, in particular breath analysis. However, my major focus has been on application of such technologies on improving our lifestyle. The result is the new concept introduced by Prof. Toumazou at the recent (2016) New Scientist Live event: Nudgeomics.

BIOGRAPHY

I received my BSc in Electronics Engineering from the university of Tehran, Iran, in 2009. Then I came to Imperial College for an MSc on Analogue and Digital Integrated Circuit Design. In 2011, I started my PhD on DNA detection using ion-sensitive transistors in CBIT. Since 2015, I have been a research associate.



Katarzyna Szostak

Research focus

Microengineering next generation probes for chronic recording

Funding

EPSRC ENGINI (EP/M020975/1)

MOTIVATION

Modern neuroscience is taking great strides towards decoding the mysteries of the brain and learning about the nature of neural conditions. Thus far, several brain interfacing methodologies varying in a technology, recording resolution and level of invasiveness have been proposed, including electroenceelography, electrocorticography and intracortical probes. Of these, the latter is the most invasive, but provides significantly better spatial and temporal resolution. Despite significant technological advancements, the long term reliability of such probes generally remains a challenge. Creating a new type of brain implant that is autonomous, simple and chronically reliable would revolutionize the field of brain machine interfaces. This is undoubtedly a highly challenging task to meet requirements in biocompatibility, material selection, mechanical behavior, performance and size and combining knowledge across many fields.

OBJECTIVES

- Design and microengineering of microsystem components for the innovative chip-scale, autonomous neural interfacing implants.
- Physical system integration ensuring chronic performance and hermeticity of all co-components.
- Adaptation of various fabrication technologies and materials for use in neural interfacing solutions.

RECENT ACHIEVEMENTS

The first step towards obtaining reliable long-term implant is to establish consistently hermetic, small-footprint, IC-compatible packaging technology that will outline space for further integration with implant components. Since ENGINI project envisages using silicon dies as a package for system on a wafer level, Kasia currently works on testing gold-tin eutectic bonding of silicon wafers for this purpose.

BIOGRAPHY

Kasia obtained both her BSc. (Hons) in Electronics and Telecommunication (2011) and Masters (Distinction) in Microsystems, Electronics and Photonics (2012) from Wroclaw University of Technology, Poland. Both her dissertations were focused on different aspects of microfabrication- silicon etching processes and wafer bonding. Katarzyna's research interests are focused on microfabrication technologies, she worked for research institutes and private companies across Europe (Poland, Germany, Belgium, and Finland) developing new processes, sensors and cleanroom based solutions. In August 2015 Katarzyna has joined the Next Generation Neural Interfaces (NGNI) group at Imperial College London where she is currently working on next generation implantable neural interfaces (ENGINI project)

PUBLICATIONS AND KEY REFERENCES

P Fattahi, *et al.* "A review of organic and inorganic biomaterials for neural interfaces." *Advanced Materials*, vol. 26, no. 12, pp. 1846–1885, 2014.

SF Cogan, "Neural stimulation and recording electrodes", *Annual Reviews in Biomedical Engineering*, vol. 10, pp. 275–309, 2008.

M Hassan, V Chodavarapu, S Musallam. "NeuroMEMS: neural probe microtechnologies", *Sensors*, vol. 8, no. 10, pp. 6704-6726, 2014.

N Saeidi, *et al.* "Technology for integrated circuit micropackages for neural interfaces, based on gold–silicon wafer bonding." *Journal of Micromechanics and Microengineering*, vol. 23, no. 7, 2013.

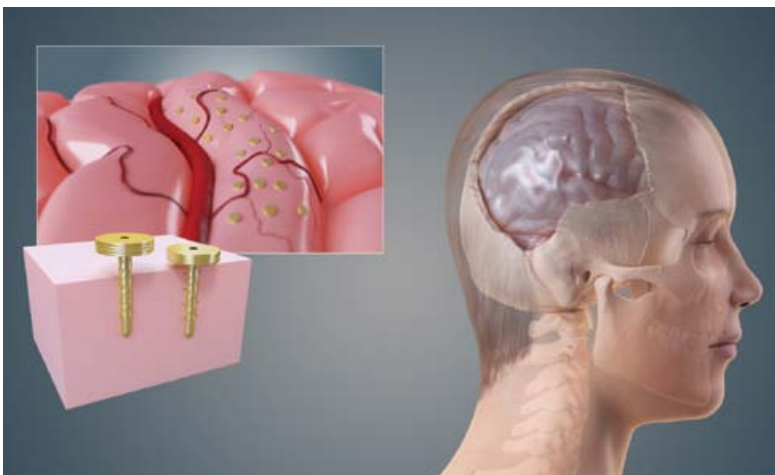

Initial concept of autonomously floating neural implants (ENGINI project)



Huan Wang, PhD

Research focus

Microfabrication of sensors and devices for medical application

Funding

Wellcome Trust

MOTIVATION

'Small Is Beautiful', is particularly true for implantable medical devices for a number of reasons. Nano/micro sized wireless implantable medical devices can not only provide 24/7 continuous and effective body condition monitoring for further diagnosis, reduce patients' pain and improve patients' life quality, but also can save healthcare cost.

With the technological advancement in semiconductor industry, medical devices, such as pressure sensors, can be pushed to a few hundreds of micrometers in size. However, due to the miniaturization, the device sensitivity and stability become very challenging to achieve. Therefore, it is essential to fabricate novel materials, explore their compatible fabrication method to improve medical devices' performance.

OBJECTIVES

Since micro-/nano-fabrication has the potential to meet such a challenging requirement of ultrasensitive medical devices, my research mainly focused on:

- Exploring new materials and effective fabrication techniques
- Integrating implantable medical devices in cleanroom
- Transferring the technology into wafer based mass production
- Designing implantable medical devices with Finite Element Analysis (FEA) (e.g. COMSOL Multiphysics)

One of my ongoing projects is to develop highly sensitive thin film acoustic wave sensors for blood pressure monitoring. I am also working on novel angioplasty balloon catheters to unblock calcified arteries.

RECENT ACHIEVEMENTS

- Fabricated AlN Thin Film Bulk Acoustic Wave Resonators (FBARs) with high Q in GHz frequencies as a key component for pressure sensors
- Developed wafer based FBARs microfabrication techniques for mass production
- Designed a catheter component with COMSOL Multiphysics simulation for novel angioplasty balloon catheters
- Designed capacitive pressure sensors with COMSOL Multiphysics simulation

BIOGRAPHY

I have done my PhD in nanofabrication and characterisation at London Centre for Nanotechnology in University College London in the area of nanowires based NEMES, especially nanomechanical resonators for mass sensing application. I joined Imperial College London to work on fabrication and characterisation of ultra-sensitive thin film implantable pressure sensors and medical devices in 2014. During this time, I have been broadening my skills in microfabrication, finite element analysis as well as implantable medical devices.

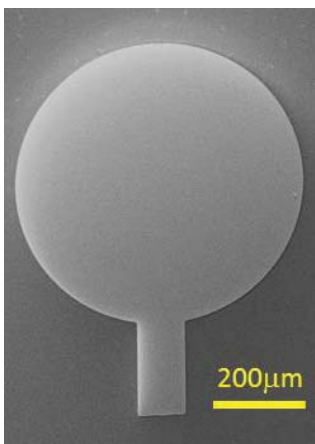

SEM image of top-view of the AlN thin film acoustic wave sensor

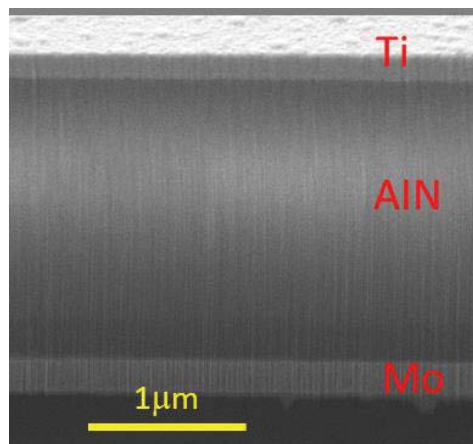

SEM image of cross-section of the AlN thin film acoustic wave sensor



COMSOL Multiphysics simulation image of Nitinol as part of a catheter tip at a vibration mode



Ian Williams, PhD

Research focus
Sensory feedback for upper limb prosthetics

Funding
EPSRC SenseBack (EP/Mo25977/1)

MOTIVATION

Advanced upper limb prosthetics are becoming increasingly capable and prevalent, however, amputees struggle to utilise even a fraction of that capability in the real world and must constantly look at the prosthesis in order to use it effectively. A key reason for this limited control and the need for visual monitoring is that the prosthesis is insensate – providing no tactile or proprioceptive feedback. This means that the control is open loop and the prosthesis will always remain a tool attached to the body rather than becoming an extension of the body itself.

OBJECTIVES

Our research aims to develop technology to improve prosthetic limb control – providing artificial proprioceptive and tactile neural feedback from an upper limb prosthesis. By selectively stimulating sensory neurons remaining in the peripheral nerves of the limb stump we aim to enable closed loop control of the limb (mirroring normal limb function). This should ultimately enable the limb to be operated with greater dexterity and without visually monitoring it.

To achieve this we are collaborating with a number of other UK universities (as part of the Senseback project) to develop flexible intraneural electrodes, miniaturised high performance stimulation & recording electronics, and models of neural signals in the human hand.



RECENT ACHIEVEMENTS

In the last year I spent some time working with the NGNI project and we successfully finished development of version 1 of our miniature, low-power, real-time, spike sorting platform and demonstrated it both in-vivo and at 2 conferences.

In SenseBack we have delivered and tested a PCB based bidirectional, neural interface platform. We have also designed and manufactured our custom, implantable IC chip providing a low power, low data rate 32-channel bidirectional neural interface.

BIOGRAPHY

Ian Williams received the M.Eng. degree in electronic engineering from Edinburgh University, UK, in 2004. From 2004 to 2010 he worked in a number of project management and research related roles for the UK Ministry of Defence. In 2014 he completed his Ph.D. in Electronic Engineering at Imperial College London, UK. His research interests include brain-machine interfaces and his doctoral research focused on developing a neural proprioceptive prosthesis for upper limb amputees.

PUBLICATIONS AND KEY REFERENCES

I Williams, A Rapeaux, Y Liu, S Luan, TG Constandinou, “A 32-Channel Bidirectional Neural/EMG Interface with on-Chip Spike Detection for Sensorimotor Feedback” *Proc. IEEE Biomedical Circuits and Systems (BioCAS) Conference*, pp. 528–531, 2016.

I Williams, S Luan, A Jackson, TG Constandinou. “A Scalable 32 Channel Neural Recording and Real-time FPGA Based Spike Sorting System”, *Proc. IEEE Biomedical Circuits & Systems (BioCAS) Conference*, pp. 187–191, 2015.

S Luan, I Williams, TG Constandinou, K Nikolic. “Neuromodulation: present and emerging methods”, *Frontiers in Neuroengineering*, vol. 7, no. 27, pp. 1–9, 2014.

I Williams, TG Constandinou. “Computationally Efficient Modelling of Proprioceptive Signals in the Upper Limb for Prostheses: a Simulation Study”, *Frontiers in Neuroscience*, vol. 8, no. 181, pp. 1–13, 2014.

In-vivo research platform under development for evaluating enabling technologies for sensory feedback



Betty Ling-Shan Yu, PhD

Research focus

Engineering rapid and sensitive electronic diagnostics for infectious diseases

Funding

EPSRC

MOTIVATION

The large outbreak of the ZIKA virus in recent years highlights the urgent need for pathogen surveillance. Current point-of-care (POC) devices have shown limitations in collecting high quality data and difficulties in reporting the data for real-time surveillance, as well as a affordable price for ODA countries.

To overcome these limitations, my aim is to develop a portable POC device compatible with a wide range of healthcare settings for ODA countries. Collection of surveillance data from diagnostic device will be integrated into a real-time platform and be made available to public health professionals, researchers and the public.

OBJECTIVES

- To establish a genomic database and customised bioinformatics pipeline for target pathogens
- To develop the a point-of-care device with isothermal detection chemistry and CMOS based lab-on-chip technology
- To report surveillance data in real-time

BIOGRAPHY

Ling-Shan Yu is a new research associate in Centre for Bio-inspired Technology. She received her B.S (Hons) from National Taiwan University and her MSc and PhD in Life Science from Imperial College London in 2016. She was awarded a Taiwanese scholarship in 2011 and outstanding perforce PhD student scholarship in life science in Imperial College London from 2013-2015. This year, she received a fellowship to continue her research in CBIT, sponsored by Taiwan and UK governments. Her areas of expertise are bioinformatics, phylogenetic analayse and developing molecular method for virus detection. Her latest research has proposed and focused on developing a point-of-care device for diagnostic infectious disease.

PUBLICATIONS AND KEY REFERENCES

T Notomi, H Okayama, H Masubuchi *et al.*, "Loop-mediated isothermal amplification of DNA", *Nucleic Acids Research*, 28(12), pp. 63e–63.

C Toumazou, P Georgiou *et al.*, "Simultaneous DNA amplification and detection using a pH-sensing semiconductor system", *Nature Methods*, 10(7), pp. 641–646.

L Yu, M Tristem. "Biogeographic and horizontal transmission history of the mammalian gammaretroviruses" (*Plos pathogen*, under review), 2016



Emerging and re-emerging infectious diseases are a major threat to human health, especially among countries eligible to receive official development assistance (ODA).

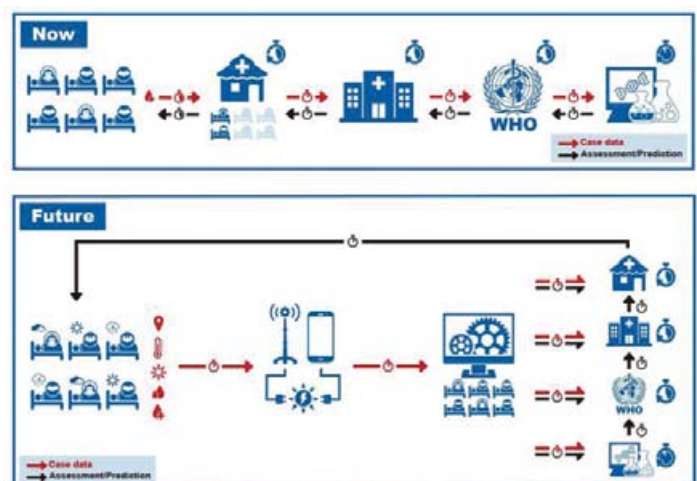

The current method of data collection and transmission for pathogen surveillance and our proposed method.



Longfang Zou, PhD

Research focus

Antennas for wireless implanted medical devices

Funding

Wellcome Trust

MOTIVATION

Wireless implanted medical devices show promising characteristics in continuous monitoring of physiological indicators and possibly raising an alert in case of need, while preserving the mobility and lifestyle of patients. They allow early detection of any degradation in patients' condition, without frequently visiting or remaining in the hospital. In addition to the clear benefits to the patients, it would be advantageous for healthcare provider by reducing recurrent expensive invasive measurements and hospitalization periods.

OBJECTIVES

- Development of implantable and wearable antennas to provide robust and bidirectional link between the implanted medical devices and external instruments
- Design, package, optimization and in vitro/ in vivo testing of implanted and body worn antennas
- Characterization of path loss in bio-tissue

RECENT ACHIEVEMENT

Various antennas have been designed and optimized to satisfy required specifications. For example, in the current blood pressure monitoring project, the implant depth of the passive sensor is larger than 6 cm. The complex, dispersive and highly lossy characteristics of human body put more emphasis on high gain and high efficiency antennas. On the contrary, subcutaneous antennas have less requirement on efficiency but more on the size. The designed antennas have met the necessary standards in phantom testing. The continuing study is devoted to improving comfort of patients and preparing animal and human trials. Meanwhile, effective inductive coupling is under

investigation to reduce the exposure level of body under electromagnetic for superficially implanted medical devices.

BIOGRAPHY

Dr Longfang Zou received the Bachelor's degree in electrical and electronic engineering from University of Electronic Science and Technology of China, in 1999 and the Master and PhD degree in electrical and electronic engineering from The University of Adelaide, Australia in 2009 and 2013, respectively. He worked at the University of Bristol prior to joining the Centre of Bio-inspired Technology, Imperial College London in 2014. His research interests include antennas, antenna arrays, computational electromagnetics and biomedical devices.

PUBLICATIONS AND KEY REFERENCES

- C Zou, P Gutruf, W Withayachumnankul, L Zou, M Bhaskaran, S Sriram, C Fumeaux, "Nanoscale TiO₂ dielectric resonator absorbers" *Optics Letters* 41(15), 3391-3394, 2016.
- C Fumeaux, C Zou, D Headland, S Nirantar, P Gutruf, L Zou, M Bhaskaran, S Sriram, W Withayachumnankul, "Terahertz and optical dielectric resonator antennas: Potential and challenges for efficient designs", *10th European Conference on Antennas and Propagation (EuCAP)*, 10-15 April, Davos, Switzerland, pp. 99-102, 2016. (Invited)
- C Zou, P Gutruf, W Withayachumnankul, L Zou, M Bhaskaran, S Sriram, C Fumeaux, "Dielectric Resonator Metasurfaces at Visible Wavelengths", *International Conference on Nanoscience and Nanotechnology (ICONN) 2016*, 7-11 February, Canberra, Australia, 2016.

Left: Implantable antennas

Right: Flexible antenna

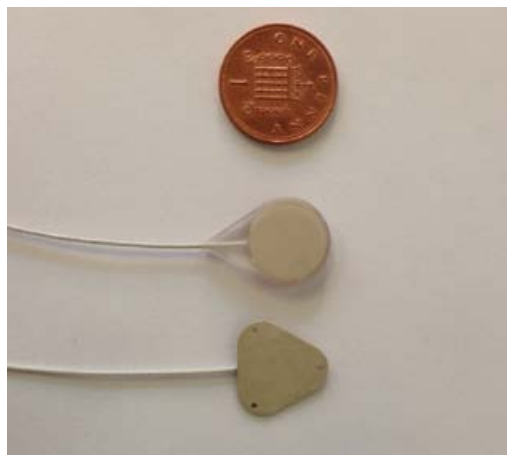



Nur Ahmadi

Research focus

Low-Power and Real-Time Low-Frequency Local Field Potential (lf-LFP) Decoding for Neural Prostheses

Supervisors

Dr. Christos-Savvas Bouganis and Dr. Timothy Constandinou

Funding Indonesian Government Scholarship

MOTIVATION

Brain-Machine Interfaces (BMIs), also known as neural prostheses, are systems which enable users to control external devices through their neural activities. Spike-based BMIs recorded using penetrating intracortical microelectrode arrays have been used to provide accurate control of prosthetic devices. However, their translation into clinically viable BMIs faces two critical challenges: instability of spiking activities over a long period of time and high-power consumption of spike sampling, processing, and/or transmission. Another type of signals in the brain, local field potential (LFP), offers attractive properties of long-term stability and low-frequency content. In addition, LFP signals have been shown to be able to decode kinematic information such as movement trajectory and velocity. LFPs, as an alternative or complementary signal to spikes, may increase the efficacy of BMIs, which can potentially improve the quality of life of millions people suffering from movement disabilities.

OBJECTIVES

The aim of this project is to develop low-power and real-time low-frequency local field potential (lf-LFP) decoder for neural prosthetic application. At first, efficient feature extraction and robust decoding algorithm have to be developed and validated. In developing the hardware, trade-off between power, latency, and area will be addressed to yield better match for the real application.

BIOGRAPHY

Nur received the B.Eng. degree in Electrical Engineering from Bandung Institute of Technology (ITB), Indonesia, in 2011 and the M. Eng. degree in Communication and Integrated Systems from Tokyo Institute of Technology, Japan, in 2013. He then worked as a research and teaching assistant at the Microelectronics Centre and School of Electrical Engineering and Informatics, ITB, for 2.5 years. Currently, he is working toward Ph.D. degree at the Next Generation Neural Interfaces (NGNI) group, within the Centre for Bio-inspired Technology, Imperial College London.

PUBLICATIONS AND KEY REFERENCES

- AK Bansal, *et al.* "Relationships among low-frequency local field potentials, spiking activity, and three-dimensional reach and grasp kinematics in primary motor and ventral premotor cortices." *Journal of neurophysiology*, vol. 105, no. 4, pp. 1603–1619, 2011.
- TM Hall, K Nazarpour, A Jackson, "Real-time estimation and biofeedback of single-neuron firing rates using local field potentials.," *Nature Communications*, vol. 5, pp. 5462, 2014.
- TM Hall, F deCarvalho, A Jackson, "A Common Structure Underlies Low-Frequency Cortical Dynamics in Movement, Sleep, and Sedation," *Neuron*, vol. 83, no. 5, pp. 1185–1199, 2014
- SD Stavisky, JC Kao, P Nuyujukian, SI Ryu, KV Shenoy, "A high performing brain-machine interface driven by low-frequency local field potentials alone and together with spikes.," *J. Neural Eng.*, vol. 12, no. 3, pp. 036009, 2015.

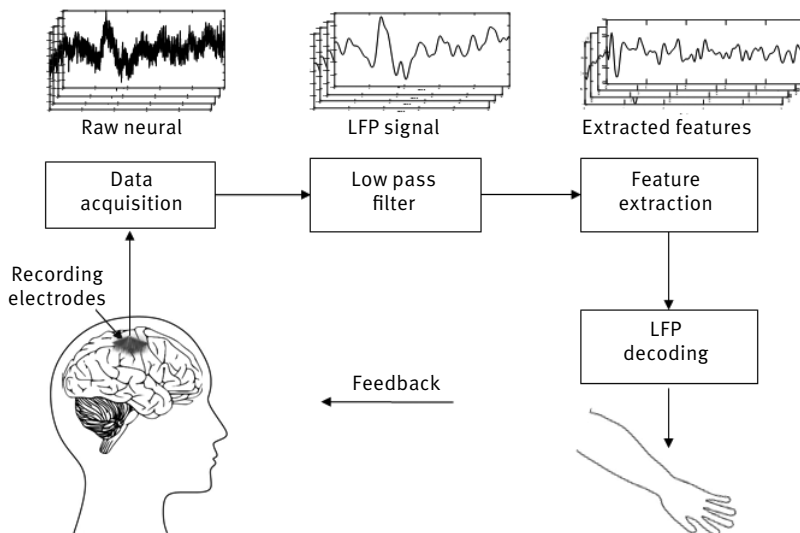



Chih Han Chen

Research focus
Expert System for personalized decision based on genetics

Supervisor
Professor Chris Toumazou

MOTIVATION

Deoxyribonucleic acid (DNA) is known to be the key to understanding the development, reproduction and functioning of all living organisms. The desire of understanding such important key molecules drives researchers to spare no effort on studying, experimenting and sharing their discovery through publications. However, due to the high complexity and large amount of the information, the knowledge of the field is rarely applied in our daily life. To apply the knowledge of genetic innovation to the market and improve and personalise our diets, healthcare, a smart framework is aimed to be designed. The framework is designed to access barcodes and nutritional information from the supermarkets and correlate to DNA information based on Nutrigenetics knowledge, in order to make suggestion of products.

OBJECTIVES

- Natural Language Processing on Bio-informatics
- Data extraction and mining with machine learning
- Business modelling for impact prediction

RECENT ACHIEVEMENT

The contribution of this research includes achieving high accuracy web information extraction to different types of websites, creating the direct GENO-product mapping system architecture and applying data value chain while solving the problems that occurs during data processing

BIOGRAPHY

I am a PhD student under supervision of Prof. Christofer Toumazou and co-supervised by Prof. Yike Guo. My backgrounds cover the fields of Micro-electronics, Business management, Big data computing and Analogue and Digital Integrated Circuit design. My recent research is working with Machine learning on Genetics to personalised decision.

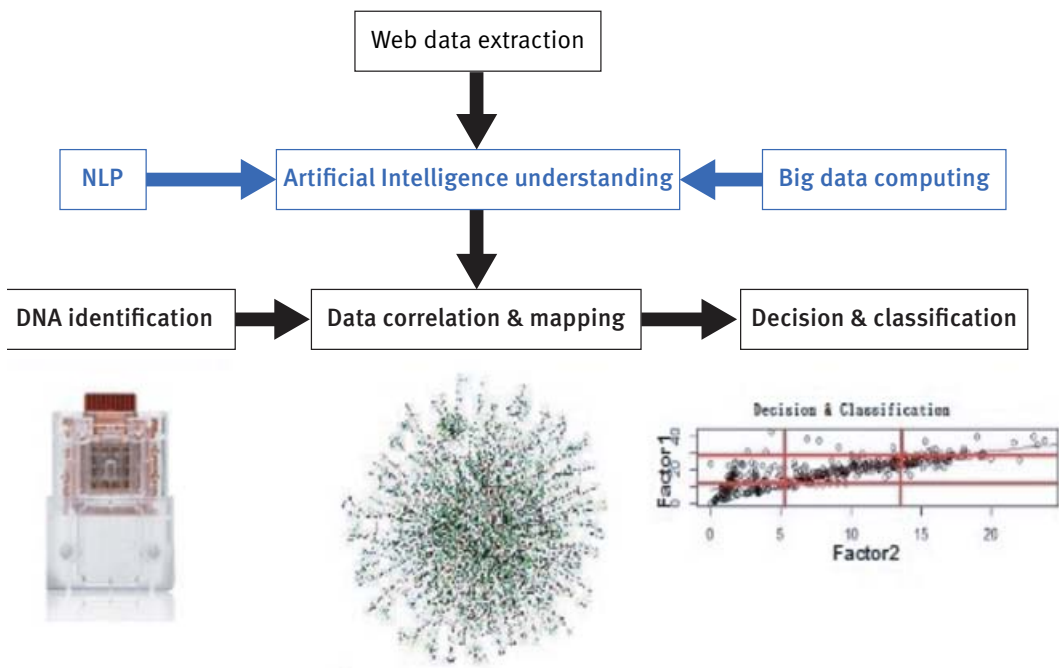



John S M Daniels

Research focus

Towards the development of Bio-inspired Artificial Pancreas (BiAP) for use in the home

Supervisor

Dr Pantelis Georgiou

Funding

Dexcom

MOTIVATION

The International Diabetes Federation estimates that 415 million people are living with diabetes in 2015. Given that this number is expected to rise to 615 million in 2050, diabetes is one of the most pressing issues that needs to be urgently addressed in our world today.

Radically increased computing capabilities along with the proliferation in improved sensor technology provide the resources necessary to minimise the complications associated with living with diabetes. As a result, the current initiative is to develop an artificial pancreas system for Type 1 diabetics to use in the home.

OBJECTIVES

- To develop a bio-inspired artificial pancreas with low power requirements to minimise charging needs. A key challenge lies in consequently, minimizing the operation of peripheral devices in the system to conserve power.
- To improve on the robustness of the wireless communication for a more reliable system suitable for the home.
- To design and develop fault detection features to improve overall safety for the patient.

RECENT ACHIEVEMENT

Over the last 12 months, the BiAP handheld device has undergone improvements to increase the overall reliability of the system. The device is now compatible with a Tandem/CellNovo insulin pump and a Dexcom CGM and is able to recover from possible dropouts in communication.

In addition, the system is now able to seamlessly integrate an optional Advanced Meal Bolus Calculator feature to make improvements in the efficacy of insulin dosage.

BIOGRAPHY

John received his M.Eng (Hons) in Electrical and Electronic Engineering with Management in 2015. Having completed an individual project in his final year on the topic of glucose control for patients in critical care, he joined the Centre for Bio-inspired Technology as a Research Assistant to work on the bio-inspired artificial pancreas project for the home.

PUBLICATIONS AND KEY REFERENCES

M Reddy, P Herrero, M El-Sharkawy, P Pesl, N Jugnee, H Thomson, D Pavitt, C Toumazou, D Johnston, P Georgiou, N Oliver. "Feasibility study of a bio-inspired artificial pancreas in adults with type 1 diabetes", *Diabetes technology & therapeutics*, vol.16, no.9, pp. 550–557, 2014

M Reddy, P Herrero, M El-Sharkawy, P Pesl, N Jugnee, D Pavitt, IF Godsland, G Alberti, C Toumazou, D Johnston, P Georgiou, N Oliver. "Metabolic Control With the Bio-inspired Artificial Pancreas in Adults With Type 1 Diabetes A 24-Hour Randomized Controlled Crossover Study", *Journal of Diabetes Science and Technology Therapeutics*, 2015



BiAP system with the Advanced Meal Bolus feature



Matthew Douthwaite

Research focus

Investigating wearable, self-powered electrochemical sensing devices for non-invasive monitoring of human physiology

Supervisor

Dr Pantelis Georgiou

Funding EPSRC CDT in HiPEDS

MOTIVATION

In recent years, the development of microelectronics has facilitated lab-on-chip technology to detect DNA and ions in massively parallel arrays of ISFETs. Diagnostics of this nature are lab-based and use samples of blood or genetic material collected from a user.

My research aims to utilize the miniaturized robust nature of CMOS technology to create lab-on-body style wearable devices which analyse sweat and wirelessly report the results to provide continuous monitoring of physiology for athletes or patients. Additionally, the low-power requirements of CMOS allow the exploration of on-body energy harvesting techniques to create completely self-sufficient wearable devices.

OBJECTIVES

- Attain a measured comparison between ISFETs and ISEs for the detection of analytes present in sweat.
- Design a wearable CMOS integrated device for sweat analysis.
- Demonstrate energy harvesting for a wearable application.

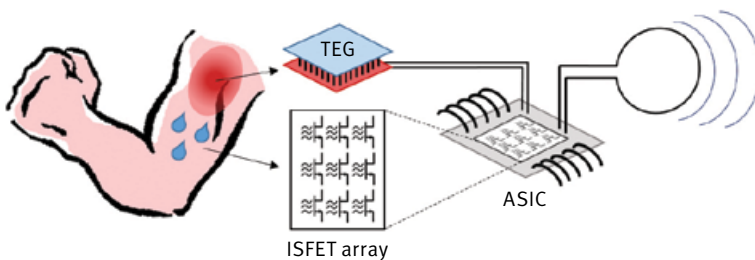

System as described

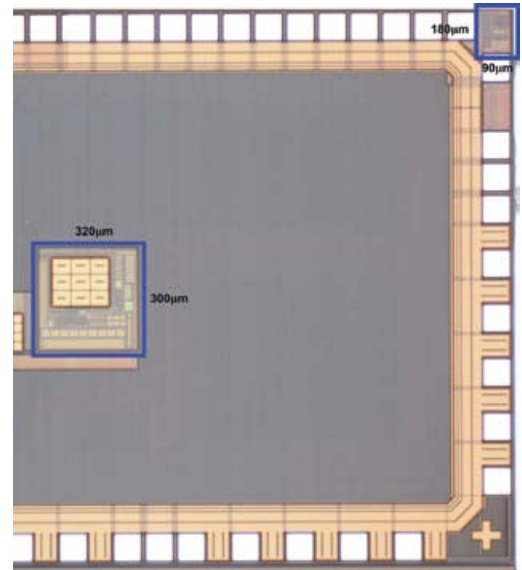

Microphotograph of the die containing the system described, with two sections highlighted in blue.

RECENT ACHIEVEMENT

A paper is to be published in the proceedings of BIOCAS 2016 presenting the design of a $0.35\mu\text{m}$ CMOS integrated circuit containing a 3×3 ISFET array for the purposes of sweat analysis. The prototype chip carried out a pH to time conversion and the sensing array and processing consumed less than $10\mu\text{W}$. Uncorrelated noise was shown to be reduced by using array averaging.

BIOGRAPHY

Completed MEng in Electrical and Electronic Engineering at Imperial College in 2015, during which I was awarded the Usmani Prize for microelectronics. Joined the Centre for Bio-inspired technology as part of the High Performance Embedded and Distributed Systems (HiPEDs) CDT program, funded by the EPSRC. Completed the first component of the program, a one year MRES, and moving onto the second, a three year PhD.

PUBLICATIONS AND KEY REFERENCES

M Douthwaite, N Moser, E Koutsos, D Yates, P Mitcheson, P Georgiou, (2016), "A CMOS ISFET Array for Wearable Thermoelectrically Powered Perspiration Analysis", In *IEEE Transactions on Biomedical Circuits and Systems*. Shanghai, China.



Mohamed Fayez El Sharkawy

Research focus
Bio-inspired Artificial Pancreas (BiAP)

Supervisor
Dr Pantelis Georgiou

Funding
Wellcome Trust

MOTIVATION

There are currently 3 million people suffering from Diabetes in the UK. Each day 700 people are diagnosed with the condition. There are two types of Diabetes, Type1 and Type2. The former is an autoimmune disease that stops the beta-cells in the islets of Langerhans, located in the pancreas, from secreting insulin and the latter is caused by increased insulin resistance or insulin deficiency. The lack of insulin leads to an inability of the body to keep blood glucose levels in the physiological range (4-8 mM/l). In the long term, elevated blood glucose levels, known as hyperglycaemia can lead to a number of complications such as retinopathy, neuropathy and kidney failure. Therefore an autonomous system known as the artificial pancreas (AP) which keeps glucose levels in target throughout the day would reduce the risk of complications and improve quality of life.

OBJECTIVES

- Design a low power hand-held bio-inspired artificial pancreas.
- Design the device with capability to interface to different sensors, Dexcom and Medtronic continuous glucose sensors.
- Assess the clinical, and cost effectiveness of a bio-inspired artificial pancreas (BiAP) device with, and without, the addition of an adaptive bolus calculator (ABC).

RECENT ACHIEVEMENT

Passed my PhD viva with my thesis entitled “Bio-inspired Systems for Treatment of Diabetes”. Additionally, secured funding from the Wellcome Trust to assess the clinical, and cost effectiveness of a

Left: BiAP Hand-Held Unit, runs controller

Right: Current Bio-inspired Artificial Pancreas system



bio-inspired artificial pancreas (BiAP) device with, and without, the addition of an adaptive bolus calculator (ABC). 20 participants will be randomized to a bio-inspired artificial pancreas (BiAP) with a non-adaptive bolus calculator, a bio-inspired artificial pancreas with an adaptive bolus calculator (ABC) and the control group (CSII SAP).

BIOGRAPHY

I received the bachelor's degree in Electronics in 2007 from the German University in Cairo. Following that, I completed the MSc in Analog and Digital Electronics at Imperial College London in 2009. Shortly after, I began work as a research assistant in the Centre of Bio-inspired Technology, on the bio-inspired artificial pancreas project. This culminated in the completion of the PhD in 2016.

PUBLICATIONS AND KEY REFERENCES

- M Reddy, P Herrero, M El-Sharkawy, P Pesl, N Jugnee, H Thomson, D Pavitt, C Toumazou, D Johnston, P Georgiou, N Oliver. “Feasibility study of a bio-inspired artificial pancreas in adults with type 1 diabetes”, *Diabetes technology & therapeutics*, vol. 16, no. 9, pp. 550--557, 2014
- M Reddy, P Herrero, M El-Sharkawy, P Pesl, N Jugnee, D Pavitt, IF Godsland, G Alberti, C Toumazou, D Johnston, P Georgiou, N Oliver. “Metabolic Control With the Bio-inspired Artificial Pancreas in Adults With Type 1 Diabetes A 24-Hour Randomized Controlled Crossover Study”, *Journal of Diabetes Science and Technology Therapeutics*, 2015
- M El-Sharkawy, P Georgiou “A study of pancreatic cell coupling for improved glucose sensing”, *Biomedical Circuits and Systems Conference (BioCAS)*, 2014 IEEE, pp. 556—559.



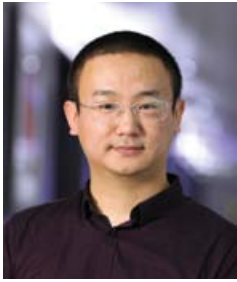

Peilong Feng

Research focus

Completely wireless infrastructure for distributed mm-sized neural implants

Supervisor

Dr Timothy Constandinou

MOTIVATION

Neural prostheses bring many benefits for the deaf, blind and disabled patients to reconstruct their sensory, cognitive and motor function. Meanwhile, neural implants become a powerful investigative tool for neuroscience to discover how brain works and explore possible cures for brain diseases. In the future neural interface may be applied to some consumer electronics and further improve the human beings' life. My work focuses on developing a low-power mm-scale implanted wireless neural interface for power delivery and data communication.

OBJECTIVES

- To optimize the configuration of distributed implants by establishing the trade-off between power efficiency, communication bandwidth, location and orientation;
- To develop electronic circuits (to connect to both primary and secondary coils) for energy management such that energy can be efficiently transferred and utilized; and
- To develop distributed data links formed by many independent and bidirectional channels.

RECENT ACHIEVEMENT

Inductive links have been analysed and designed by using analytical models, electromagnetic simulation

software. Three types of mm-sized on-chip coils have been designed and fabricated for power transmission system. A high efficient rectifier is implemented by using low threshold devices.

BIOGRAPHY

Peilong Feng received the B.E. degree in electrical engineering from the Henan Polytechnic University, China, in 2011, the M.S. degree in microelectronic systems design from University of Southampton, UK, in 2012, and the M.S. degree in analogue and digital integrated circuit design from Imperial College London, UK, in 2015. He is currently pursuing the Ph.D. degree in the Next Generation Neural Interfaces (NGNI) Lab at the Imperial College London. From 2012 to 2014, he worked as an electronic engineer in Shanghai Research Institute, China Coal Technology and Engineering group.

PUBLICATIONS AND KEY REFERENCES

S Kim, JS Ho and ASY Poon, "Wireless Power Transfer to Miniature Implants: Transmitter Optimization," in *IEEE Transactions on Antennas and Propagation*, vol. 60, no. 10, pp. 4838–4845, 2012.

D Ahn, M Ghovanloo, "Optimal Design of Wireless Power Transmission Links for Millimeter-Sized Biomedical Implants," in *IEEE Transactions on Biomedical Circuits and Systems*, vol. 10, no. 1, pp. 125–137, 2016.

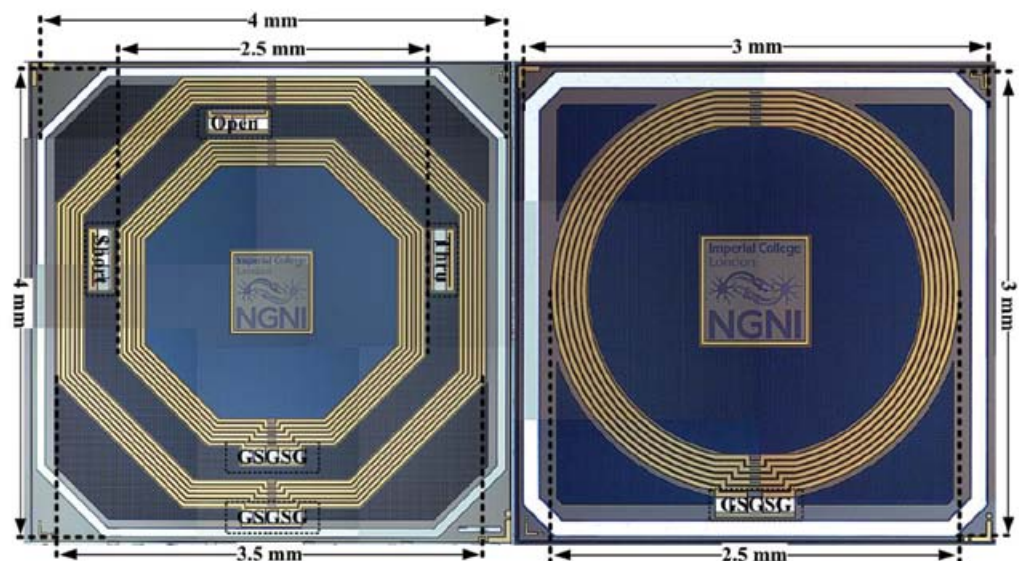

mm-sized on-chip coils for receiving power and data. (left) octagonal coils with 2.5mm and 3.5mm outer diameter. (right) circular coil with 2.5mm outer diameter.



Onur Guven

Research focus

Ultra Low Power Microelectronics for Robust ECG Signal Conditioning

Supervisor

Dr Timothy Constandinou

Funding

Texas Instruments Corporation

OBJECTIVES

ECG's non-invasiveness coupled with the growing trend in wearable, ambulatory systems still carries critical challenges for accuracy, noise and artefact removal. An embedded system approach for maintaining the ECG signal integrity has been investigated throughout the research. The main focus is to estimate the baseline wander (BW), electrode offset and motion artefacts in the digital domain and to subtract from the original signal through a feedback mechanism. This feedback operation of the overall system avoids conventional high pass filtering as in low-resolution ECG solutions, and eliminates low frequency distortion to the ECG signal and provides real time ECG measurements.

While maintaining these requirements, computationally efficient baseline detection algorithm and a hybrid interpolation algorithm minimizes the number of operations and the power requirements of the overall system without requiring bulky computerised operation.

BIOGRAPHY

Onur Guven received the BSc degree in electrical and electronic engineering from the Bosphorus University at Istanbul, Turkey, and the MSc degree in analogue

and digital IC design from Imperial College London, UK, in 2008 and 2009, respectively. He has been working toward for the PhD degree at the Centre for Bio-Inspired Technology, Imperial College London and completed his Ph.D thesis in August 2016. His main interests are biomedical signal processing, embedded system design and IC circuit design.

PUBLICATIONS AND KEY REFERENCES

O Guven, A Eftekhar, W Kindt, TG Constandinou, "Computationally-efficient realtime interpolation algorithm for non-uniform sampled biosignals", *IET Healthcare Technology Letters*, 2016.

O Guven, A Eftekhar, R Hoshyar, G Frattini, W Kindt, TG Constandinou, "Realtime ECG Baseline Removal: An Isoelectric Point Estimation Approach," *Proc. IEEE Biomedical Circuits and Systems (BioCAS) Conference*, pp. 29–32, 2014.

GM Friesen, TC Jannett, MA Jadallah, SL Yates, SR Quint, HT Nagle, "A comparison of the noise sensitivity of nine QRS detection algorithms," *IEEE Transactions on Biomedical Engineering*, vol. 37, no. 1, pp. 85–98, 1990.

C Meyer, H Keiser, "Electrocardiogram baseline noise estimation and removal using cubic splines and state-space computation techniques," *Computers and Biomedical Research*, vol. 10, no. 5, pp. 459–470, 1977.

Embedded system BW estimations of the real ECG signal in presence of the ambulatory BW

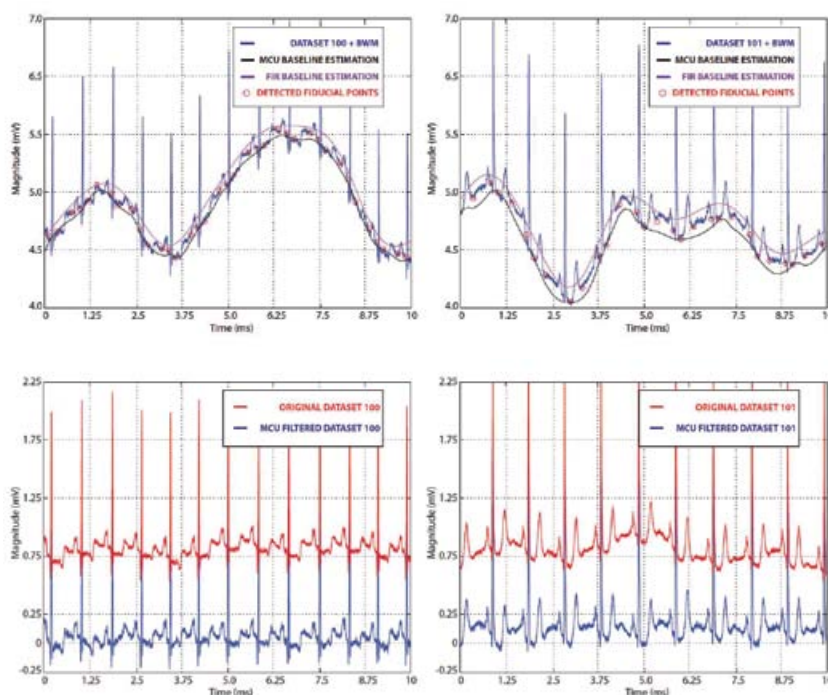



Dorian Haci

Research focus

Integrated Circuit and Embedded Platforms for Next-Generation Implantable Medical Devices

Supervisor

Dr Timothy Constandinou

Funding

Wellcome Trust/EPSC (NS/A000026/1) CANDO

MOTIVATION

Recently, in part due to progress in microtechnology, advanced devices that effectively communicate with the nervous system have been developed for a number of medical applications. Such devices, referred to as neural interfaces or neural implants, exploit the electrical behaviour of the nerve cells both for recording the electrical activity and stimulating the neural tissue (thus modulating activity).

Within the CANDO project, an implantable medical device is being developed that has the requirement for multiple modules to reliably interact (i.e. to share power supply and achieve bi-directional communication). My research is thus focused on defining of an appropriate communication protocol and implementing the reliable communication interface intended ultimately for a first-in-man trial.

OBJECTIVES

Identify and implement an interfacing system that allows neural implants to efficiently connect between each other in an intra-body environment and perform reliable bidirectional data communication and power transfer.

Investigate and implement addressing techniques and algorithms to guarantee univocal accessing and avoid data collision in multi-module neural implants.

Develop and test of instrumentation platforms to emulate the biological tissues for purposes of evaluating electronic hardware.

RECENT ACHIEVEMENTS

During the last year, a neurosignal generation platform has been implemented and tested. This will be used to replicate pre-recorded high dynamic range (100dB), low noise (mV level) signals (32-channels concurrently) from a digital memory card.

Secondly, a 4-wire interfacing system has been designed, in collaboration with colleagues (Dr Liu, Dr Ghoreishizadeh), for connecting multiple neural probes, providing them with intra-communication and power management capabilities. The interface has been fabricated in a commercially available 0.35µm CMOS technology. Moreover, a number of novel structures for generating unique IDs (within each module) have been separately implemented within the same technology initially for test & evaluation purposes.

BIOGRAPHY

In 2012, Dorian received his BSc in Electronic Engineering at the Polytechnic University of Turin, Italy. He continued his studies with an MSc in electronic engineering, specialising in Communication Systems. He was awarded a scholarship for developing the MSc thesis project at Imperial College London, where he designed and implemented an innovative thermally controlled system for bio-applications using low cost PCB technology. Dorian received his MSc in Turin in December 2014 and joined the Next Generation Neural Interfaces (NGNI) group at the Centre for Bio-Inspired Technology as a Research Assistant in June 2015. Currently, he is also pursuing the PhD degree under the supervision of Dr. Timothy Constandinou.

PUBLICATIONS AND KEY REFERENCES

- EG Kilinc, C Dehollain, F Maloberti, "Remote powering and Data Communication for implanted biomedical systems", Springer International Publishing, 2016.
- S Bhunia, S Majerus, M Sawan (Eds.), "Implantable Biomedical Microsystems: Design Principles and Applications", Elsevier, 2015.
- G Buzsáki, CA Anastassiou, C Koch, "The origin of extracellular fields and currents—EEG, ECoG, LFP and spikes", *Nature Reviews Neuroscience*, vol. 13, no. 6, vol. 407–420, 2012.

Top: ID generation circuits and test structures (highlighted) implemented in 0.35µm CMOS Technology

Bottom: Printed Circuit Boards (PCB) of instrumentation platforms to emulate biological tissue and IC test platforms

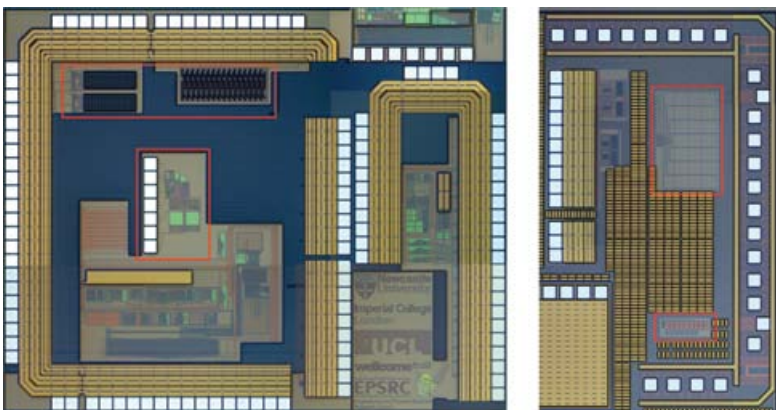



Bernard Hernandez

Research focus

Enhanced, Personalized and Integrated Care for Infection Management at Point of Care (EPIC IMPOC)

Supervisor

Dr Pantelis Georgiou

Funding

NiHR i4i

MOTIVATION

Bacteria and other microorganisms are a common cause of infections. The antimicrobials are drugs that kill or stop the growth of microorganisms, thereby are commonly used to treat infections. Antimicrobial Resistance (AMR) has been a major issue in the last years and attempts have been made to palliate its growth. Misuse of antibiotics in humans is a main concern and therefore prescription behavior needs to be studied and modified appropriately. A common approach relies on designing software tools to promote knowledge transfer and awareness.

In addition, a vast amount of data is being collected by hospitals every day containing valuable AMR-related information. However, little efforts have been made to integrate such information into patient management systems to benefit clinicians' prescription practices. Therefore, there is an opportunity to develop an advanced decision support system that uses such large amount of data by applying machine learning algorithms to provide personalized, accurate and effective diagnostics at point of care.

OBJECTIVES

Design a Decision Support System that provides personalized, accurate and effective diagnostics at point of care.

Determine the likelihood of infection for a patient from routinely collected pathology biomarkers.

Define a standard process to clean microbiology data and measure antimicrobial resistance and its evolution.

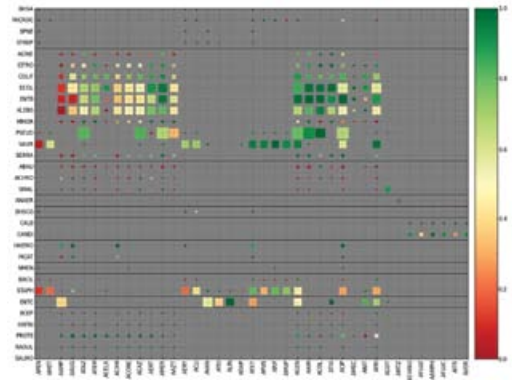

Hinton diagram representing the sensitivity for individual pairs of organism (y-axis) and antibiotic (x-axis).

RECENT ACHIEVEMENT

Regarding the inference of infection from routinely collected pathology biomarkers, despite the low number of biomarkers considered, infection detection is feasible and the results are significantly better than those presented in previous studies with an AUC of 0.87. To represent and measure antimicrobial resistance and evolution pairs (organism, antibiotic) are widely accepted by clinicians. Commonly annual surveillance is rough and imprecise while monthly surveillance presents elevated levels of noise. Therefore, the sliding-window technique is applied to compute high-quality time-series. Later a line is fitted using Linear Regression and its slope used to quantify its growth.

BIOGRAPHY

Bernard Hernandez is research assistant and PhD candidate at Imperial College London. His PhD topic is to design a Decision Support System that provides personalized, accurate and effective diagnostics at point of care to reduce Antimicrobial Resistance. He received his B.S in Telecommunications and Computer Science from the University Rey Juan Carlos (URJC) in Madrid and his M.Sc. in Machine Learning from the Royal Institute of Technology (KTH) in Stockholm.

PUBLICATIONS AND KEY REFERENCES

B Hernandez, P Herrero, L SP Moore, E Charani, A Holmes, P Georgiou, "Point-of-Care Decision support System for Antimicrobial Prescribing in the Intensive Care Unit" Poster session presented at: Imperial College London. *EMBRACE conference in Antimicrobial Resistance 2016*, Mar 9, London UK.

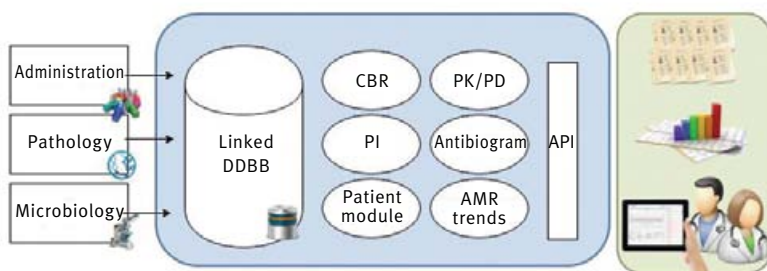

High-level diagram describing the main components of the DSS.

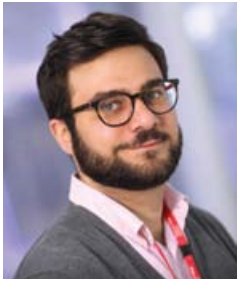

Mr Ermis Koutsos

Research focus

Low-power real-time sEMG fatigue monitoring ASICs for rehabilitation of osteoarthritis

Supervisor

Dr Pantelis Georgiou

Funding

EPSRC DTA

MOTIVATION

Electromyogram (EMG), the recording of the electrical impulses of the muscles, is a rich source of information, which can facilitate such an insight into our muscles and especially their activation and fatigue level. Muscle fatigue has been shown to be one of the most important biofeedback parameters of EMG in rehabilitation, ergonomics and training, by using measured results from the body to change the way we behave, improve our performance and achieve better compliance to rehabilitation.

This is achieved by estimating a muscle's fatigue state though monitoring surface EMG signals, with the use of low power integrated circuits. CMOS technology facilitates localised real-time processing to achieve complete miniaturization. Thus, reducing requirements on data transmission, saving power and increasing the degree of freedom for the user.

OBJECTIVES

- Develop a muscle fatigue monitoring System-on-Chip (SoC).
- Achieve efficient independent processing for reduced data transmission.
- Achieve real-life unsupervised operation.

RECENT ACHIEVEMENT

Our latest fabricated IC, capable of real-time estimation of the median frequency of the sEMG signal, is embedded in the second version of our compact, energy efficient, wearable device that extracts muscle fatigue through monitoring of surface EMG. This wearable node can be applied to any muscle



Second version of wearable node with an updated muscle fatigue tracking ASIC.

of the body, thus providing a tool to aid in rehabilitation or muscle research. This work resulted in follow-on funding from the 2016 EPSRC Doctoral Prize Fellowship.

BIOGRAPHY

Ermis Koutsos received his BSc degree in Electrical and Electronic Engineering from University of Surrey – U.K., in 2011 and his MSc in analogue and digital integrated circuit design from the Dept. of Electrical and Electronic Engineering of Imperial College London – U.K., in 2012. Since 2012 he is a PhD candidate in the Centre of Bio-Inspired Technology, Institute of Biomedical Engineering, Imperial College London, under the supervision of Dr. Pantelis Georgiou. His research interest focuses on the design of low power mixed signal electronics for biomedical applications. Mr. Koutsos is a scholar of EPSRC and the 2016 EPSRC Doctoral Prize Fellowship.

PUBLICATIONS AND KEY REFERENCES

E Koutsos, V Cretu, P Georgiou, "A Muscle Fibre Conduction Velocity Tracking ASIC for Local Fatigue Monitoring," *Circuits and Systems, IEEE Transactions on*, 2016

S-Y Chiou, E Koutsos, P Georgiou, P H Stratton, "Spectral characteristics of paraspinal muscles and functional disability in low back pain," *PLOS*, 2016, (under review)

First version of wearable node with dedicated muscle fatigue tracking ASIC and custom Android monitoring application.





Timo Lauteslager

Research focus

Functional neuroimaging using ultra-wideband radar

Supervisor

Dr Timothy Constandinou

Funding

EPSRC DTA and EEE Departmental Scholarship

MOTIVATION

In the current project we collaborate with University of Oslo to use microwave techniques for non-invasive functional neuroimaging. Specifically, we will use a single chip implementation of an impulse-radio ultra-wideband (IR-UWB) radar system to measure changes in regional cerebral blood volume. By constructing a helmet with an array of antennas and using digital beamforming techniques, it should be possible to detect and locate brain activity non-invasively.

The brain imaging device we envision will be portable, low-cost, and will have sufficient temporal resolution to accurately track brain activity. This would allow for ambulatory assessment, as well as affordable neuroprosthetics.

OBJECTIVES

- To develop imaging hardware: multistatic radar and body-coupled antenna array;
- To develop relevant techniques for signal processing and digital beamforming; and
- To test the imaging setup on phantom and human subjects.

RECENT ACHIEVEMENT

As an initial verification that small changes in cerebral blood volume can indeed be measured inside the skull, we recorded the heart rate intracranially using a single radar module and two body coupled antennas. The obtained heart rate was found to correspond to ECG measurements. Simulated time-of-flight through the brain corresponded to the measured delay of heart rate modulation in the radar signal, confirming that the recorded signal was indeed from within the skull. The detection of intracranial heart rate using microwave techniques has not previously been reported, and serves as a first proof that functional neuroimaging using radar could lie within reach.

BIOGRAPHY

Timo Lauteslager followed his undergraduate in Biomedical Engineering at the University of Twente, The Netherlands, where he received his BSc degree in 2012. Subsequently he was awarded with a 2 year Erasmus Mundus scholarship from the European Committee. This scholarship allowed him to follow a joint degree master program in Biomedical Engineering, at Czech Technical University and Trinity College Dublin. He specialized in biosignal processing and neural engineering. In 2014 he received his MSc with distinction from both universities. Timo has joined the Next Generation Neural Interfaces (NGNI) group within the Centre for Bio-inspired Technology as a PhD candidate in January 2015.

PUBLICATIONS AND KEY REFERENCES

T Lauteslager, N Nicolaou, TS Lande, TG Constandinou, "Functional neuroimaging using UWB impulse radar: A feasibility study," *Proc. IEEE Biomedical Circuits and Systems (BioCAS) Conference*, pp. 406–409, 2015.

T Lauteslager, M Tømmer, KG Kjelgård, TS Lande, and TG Constandinou, "Heart Rate Detection Using UWB Radar," *Proc. IEEE Biomedical Circuits and Systems (BioCAS) Conference*, pp. 119–122, 2016 (best paper award).

Radar and antenna

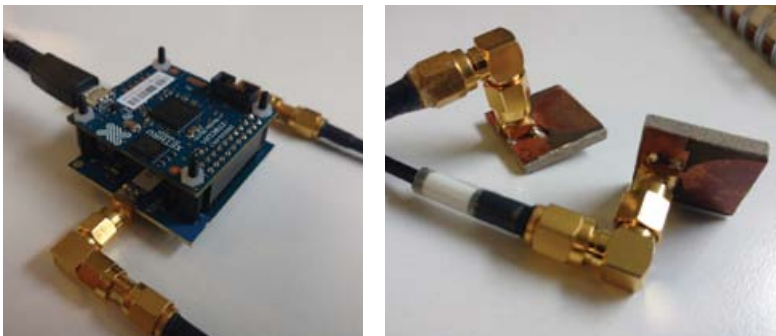

UWB-IR radar platform showing: electronics (left); and body coupled antennas (right).

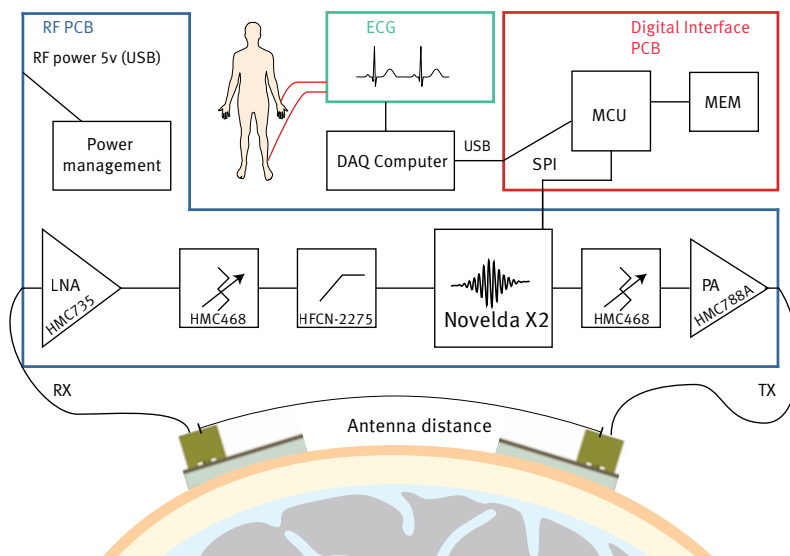

Experimental setup for measuring and validating detection of intracranial heartbeat



Lieuwe B Leene

Research focus

Developing the next generation neural interfacing & sensor systems

Supervisor

Dr Timothy Constantinou

Funding

EPSRC ENGINI (EP/M020975/1)

MOTIVATION

Current trends in neuroscience and commercially available biomedical electronics have demonstrated great promise for delivering better health care. However there is a growing need for robust system on chip integration to achieve sub-millimeter size bio-signal sensors in order to advance state-of-the-art and realize these new opportunities.

This effort raises new challenges beside the conventional focus power and noise. Brain machine interfaces in particular necessitate highly adaptive functionality to decode neural activity in an effective manner. Such demanding capabilities have yet to be accommodated efficiently that allows system integration in a scalable fashion. This motivates the use of emerging technologies and other processing modalities to find more effective BMI implementations.

OBJECTIVES

- Develop scalable and highly reconfigurable architectures for distributed BMI sensor systems
- Model system requirements in relation to on-chip resource requirements to enable high level analytic optimization
- Explore mixed signal modalities that leverage digital capabilities of nanometer CMOS

RECENT ACHIEVEMENT

In the past year I have extensively developed the use of VCO based instrumentation and specialized time-domain processing structures. This is motivated by enabling nanometer CMOS technologies for sensor system integration and extensive DSP capabilities for classifying neural activity. While VCO structures have been used extensively for PLLs their application to sensors is relatively nascent where noise-optimal structures are not yet well developed.

BIOGRAPHY

Lieuwe Leene recently completed his PhD at Imperial College London specializing in developing integrated CMOS circuits for implantable healthcare devices. He received his BEng. Electronic Engineering from the Hong Kong University of Science and Technology and his MSc Analogue and Digital Integrated Circuit Design from Imperial College London. Lieuwe then joined the NGNI Neural Interfaces group at the Center for Bio-Inspired Technology as PhD student. Currently he holds a post-doc position at Imperial with the NGNI group.

PUBLICATIONS AND KEY REFERENCES

- LB Leene, TG Constandinou, "A 0.45V Continuous Time-Domain Filter using Asynchronous Oscillator Structures," *IEEE International Conference on Electronics Circuits and Systems (ICECS)*, Monte Carlo, 2016.
- LB Leene, TG Constandinou, "A 2.7uW/Mips, 0.88GOPS/mm² Distributed Processor for Implantable Brain Machine Interfaces," *IEEE Biomedical Circuits and Systems Conference (BioCAS)*, Shanghai, 2016.
- M Elia, LB Leene, TG Constandinou, "Continuous-time micropower interface for neural recording applications," *IEEE International Symposium on Circuits and Systems (ISCAS)*, Montreal, pp. 534-537, 2016.

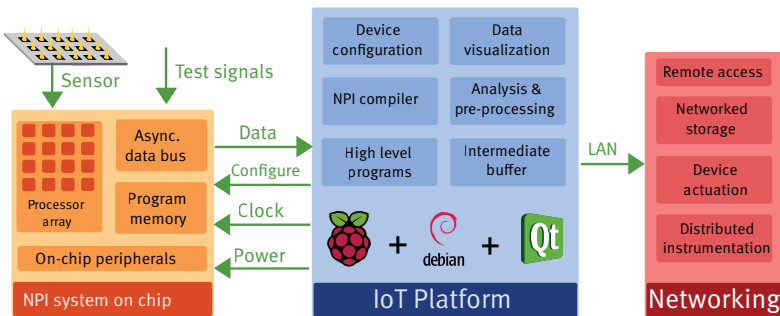

Fully integrated neuron-processor interface (NPI) with fully programmable instrumentation & signal processing capabilities



PCB evaluation platform of the neuron-processor interface prototype for developing on-chip classification methods for neural spiking activity
 (1) ARM core (2) NPI core (3) Serial I/O (4) Analogue power (5) Digital power (6) Sensor input (7) Display (*) LAN port (9) USB HDI



Dora Ma

Research focus

ET based epigenetic biomarkers for early detection of Chronic Kidney Disease

Supervisor

Professor Chris Toumazou

Funding

EEE Departmental Scholarship

MOTIVATION

Chronic kidney disease (CKD) is one of the most common diseases affecting many people, with 1.8 million confirmed diagnoses in the UK alone. With the number increasing, the emphasis when treating CKD is to prevent patients from reaching end-stage renal failure, which results in the need for dialysis or kidney transplant. The chances of kidney failure decreases with early detection and adequate management.

Recently, there has been strong evidence showing the role of epigenetics in the development and progression of chronic kidney disease. This implies the potential to develop CMOS microchips for detecting epigenetic biomarkers that can be used out of laboratory for quick diagnosis.

OBJECTIVES

- Development of a methylation detection circuit that can provide fast and simple results on multiple genes for the use in point-of-care systems.
- Design and implement a system that can perform on-chip quantification based on real time PCR.
- Development of an analogue signal processing circuit for use in detailed methylation analysis based on bisulphite sequencing techniques.

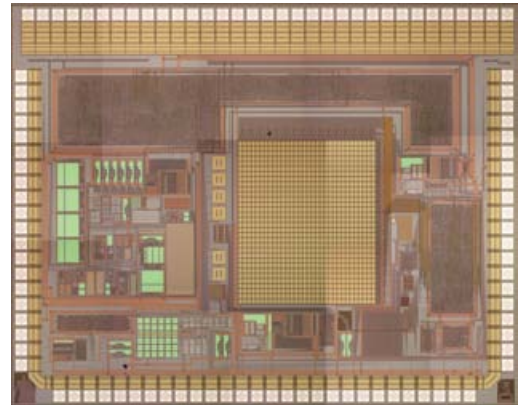

First generation chip

RECENT ACHIEVEMENT

Poster presentation on “A weak inversion ISFET current mirror for differential bio-sensing” at BioCas conference, Shanghai.

BIOGRAPHY

I am a fourth year PhD student. I graduated from Imperial College in 2013 with a MEng from the department of Electrical and Electronic Engineering. Having done my final year project on analogue signal processing for DNA sequencing with Professor Toumazou, I continued to pursue my PhD in a similar area.

PUBLICATIONS AND KEY REFERENCES

D Ma, P Georgiou, C Toumazou. “An ISFET-based switched current DNA integrator.” *Circuits and Systems (ISCAS), 2016 IEEE International Symposium on.* IEEE, 2016.

D Ma, P Georgiou, C Toumazou. “A weak inversion ISFET current mirror for differential bio-sensing.”, *2016 IEEE Biomedical Circuits and Systems Conference (BioCAS).* IEEE, 2016.

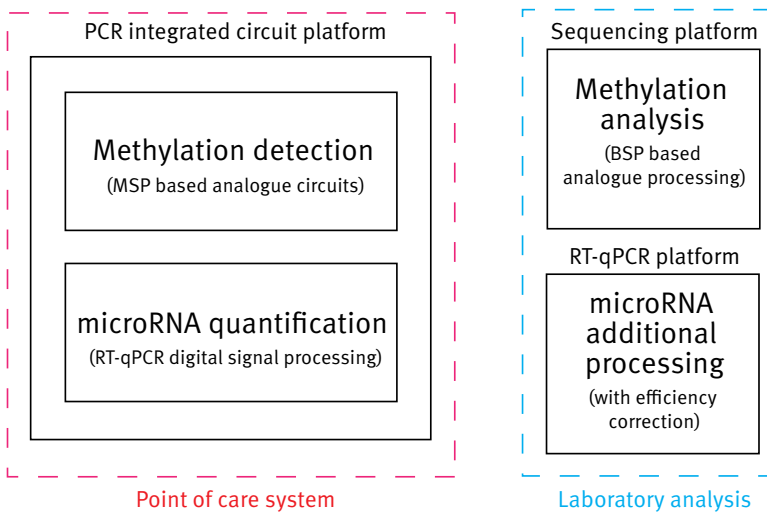

Overview of point of care and laboratory epigenetic detection systems



Federico Mazza

Research focus

Integrated Devices for Reliability and Long-Term Stability of Neural Implants

Supervisor

Dr Timothy Constandinou

Funding

EPSRC DTA and ENGINI project (EP/Mo20975/1)

MOTIVATION

The use of neural prostheses have already had impact in treating multiple neurological conditions, with deep brain stimulation (DBS) for Parkinson's disease, essential tremor, dystonia, and cochlear implants for profoundly deaf individuals. In the future, such technology will extend to motor pathways, aimed to give patients, for example, the control over the movements of artificial prosthetics.

Lately, research in the field of neural interfaces has rapidly grown, thanks to advancements in the characterization of brain signals, microfabrication technologies, and real-time signal processing methods. Although several implantable, high channel count recording systems have been demonstrated in research settings, in order to make these chronically viable for clinical applications, there exists the challenge of chronic stability. Resolving issues such as the reliability of the electrode/tissue interface, and the reliability of packaging/encapsulation are critical towards implementing future systems.

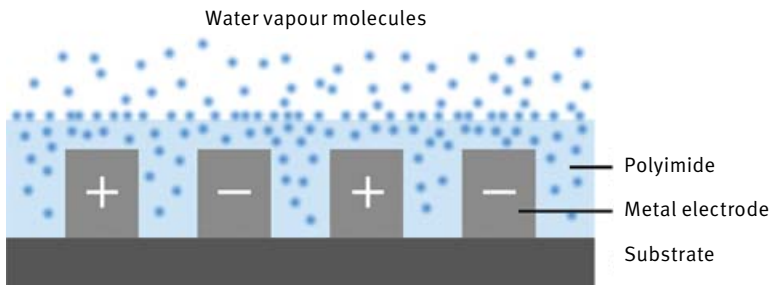

Cross-section of an interdigitated capacitive humidity sensor

OBJECTIVES

- Demonstrate a reliable in situ, non-destructive method to test the encapsulation of implantable neural micro-packages, employing the principle of humidity sensing for leakage monitoring.
- Integrate the above mentioned testing method within the structure of a distributed neural interface. This implies the design of a transmission system to allow wireless readout of the humidity sensing circuit without compromising the hermetic properties of the micro-package.
- Investigate different approaches for the microfabrication of highly-scalable feedthrough connections in neural implantable devices. This will include reviewing/designing/testing advanced system integration technologies, such as die stacking, interposers, and through-silicon vias, and evaluating the impact they have on corrosion and hermeticity.

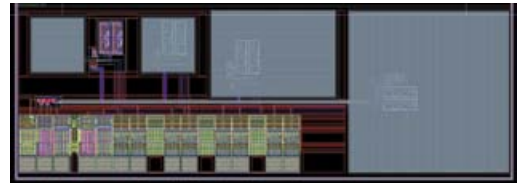

Chip layout of the capacitive sensory system implemented in AMS 0.35µm CMOS technology

RECENT ACHIEVEMENT

During the first 9 months of the PhD program, the design of a relative humidity capacitive sensor has been completed, from numerical simulations to a complete IC layout. The sensor has been fabricated in 0.35µm CMOS technology and its performance will be tested with the help of a bench-top temperature and humidity chamber. In addition, a collaboration with Prof. Donaldson from University College London has led to the design of custom test structures for long-term *in vitro* leak tests, the results of which will provide valuable information regarding the chronic behaviour of electronic implants inside the human body.

BIOGRAPHY

Federico Mazza received his BSc degree in Electronic Engineering in 2012 from the Polytechnic University of Turin, Italy. In 2014 he obtained his MSc on Integrated Electronics and Optoelectronics as the result of a double degree program between the Polytechnic University of Turin and the University of Illinois at Chicago, USA. After working for one year in a private company operating in the field of industrial automation, he joined the Next Generation Neural Interfaces (NGNI) Group within the Centre for Bio-Inspired Technology as a PhD student in January 2016.

PUBLICATIONS AND KEY REFERENCES

- AC Patil, NV Thakor, "Implantable neurotechnologies: a review of micro-and nanoelectrodes for neural recording", *Medical & biological engineering & computing*, vol. 54, no. 1, pp. 23-44, 2016.
- S Costello, MP Desmulliez, S McCracken, "Review of test methods used for the measurement of hermeticity in packages containing small cavities", *IEEE Trans. Comp. Packag. Manuf. Technol.*, vol. 2, no. 3, pp. 430-438, 2012.
- C Eder, V Valente, N Donaldson, A Demosthenous, "A CMOS smart temperature and humidity sensor xwith combined readout", *Sensors*, vol. 14, no. 9, pp. 17192-17211, 2014.



Nicholas Miscourides

Research focus

Chemical Sensing Platforms based on ISFET Current-Mode Arrays

Supervisor

Dr Pantelis Georgiou

Funding

EPSRC CDT in HiPEDS

MOTIVATION

Chemical sensors are being established as indispensable components towards the next-generation medical devices and are key enablers in a wide range of applications such as drug/disease screening, rapid tests and ion imaging in a minimally-invasive way. Semiconductor-based ion-sensitive sensors (ISFETs) are uniquely positioned to tackle this opportunity, leveraging on the economies of scale of the CMOS industry to offer miniaturised, cheap and disposable solutions. However, as this is relatively a new technology, significant time and effort is required to ensure the robustness, reliability and longevity of the sensor. In this context, my research focuses on addressing some of the challenges involved with using Ion-Sensitive Field-Effect Transistors (ISFETs) as the sensing front-end of larger chemical sensing platform.

OBJECTIVES

Investigate alternative domains of operation, specifically looking into current-mode readout to operate the sensor and determine potential benefits compared to traditional techniques.

Compare current-mode architectures for chemical sensing that are scalable and compact with voltage-mode both qualitatively and quantitatively with measurements from the same chip. This will provide guidelines on future designers regarding the pros and cons of each domain and architecture such as pixel size and power consumption to best address the application in mind.

Look into interrogation techniques that can be used to automatically assess the performance and condition of the sensor. For example, changes in impedance of the electrolyte-silicon interface is a possible indicator of sensor degradation prompting a replacement.

RECENT ACHIEVEMENT

The last 12 months have seen the co-design and fabrication of 3 chips including ISFET circuits ranging from traditional and well-behaved circuits to experimental circuits and test structures. The highlight of this effort has been the microchip called TTN which includes 4 ISFET arrays comprising a total of 34,000 sensors. This chip will be used to test a number of hypotheses that my research is targeting including the scalability of current-mode pixels as well as impedance spectroscopy of the complete stack; reference electrode voltage down to the current that flows through the ISFET.

BIOGRAPHY

Nicholas received the M.Eng. degree (Hons) in Electrical and Electronic Engineering in July 2014 and the M.Res. degree (Distinction) in High-Performance Embedded and Distributed Systems (HiPEDS) in September 2015 both from Imperial College London. During his studies, he was awarded the Sir Bruce White Prize for the best MEng thesis of his year. Currently he is pursuing the Ph.D. degree at the Centre for Bio-Inspired Technology jointly with the HiPEDS Centre for Doctoral Training. Nicholas is an A. G. Leventis Foundation scholar.

PUBLICATIONS AND KEY REFERENCES

N Miscourides, P Georgiou, "Linear Current-Mode ISFET Arrays," in *2016 IEEE International Symposium on Circuits and Systems (ISCAS)*, May 2016, pp. 2827–2830.

N Miscourides, P Georgiou, "A Linear Programmable-Gate ISFET Array Operating in Velocity Saturation," in *2016 IEEE Biomedical Circuits and Systems Conference (BioCAS)*, October 2016.

Microphotograph of the TTN chip (2x4mm²) showing 4 ISFET arrays with a total of 34K sensors with applications in hydrogen ion imaging.

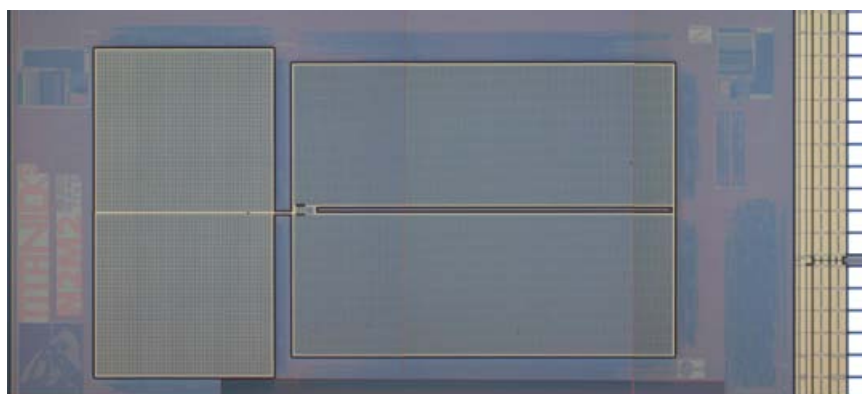



Khalid Baig Mirza

Research focus

Research and Development of stimulation technology for non-invasive obesity management

Supervisor

Professor Chris Toumazou/Dr Amir Eftekhar

Funding

EPSRC

MOTIVATION

WHO statistics indicates obesity as the second largest preventable cause of death after tobacco consumption and current estimates put the cost of obesity management at \$ 47 billion, \$ 6 billion of which is shared by NHS alone.

Gastric Bypass Surgery is expensive and accompanied by many complications. Therefore, it is necessary to explore suitable alternatives such as Vagus Nerve Stimulation (VNS) since the vagus nerve plays a major role in appetite regulation and food intake[2] and couple it with accurate markers of appetite to enhance effectiveness of the therapy.

OBJECTIVES

- Develop implantable technology to enable intelligent, invasive monitoring of appetite at neural level.
- Explore options for non-invasive monitoring of appetite through biomarkers leading towards a non-invasive solution for obesity management.

RECENT ACHIEVEMENTS

- Explored the possibility of using ultrasonic waves as a non-invasive stimulation paradigm.
- Developed chip level technology to record electrical signals on the nerve.

BIOGRAPHY

I completed my MSc in Analogue and Digital IC Design from Dept. of Electrical and Electronic Engineering, Imperial College London and started working as an Electronics Engineer for Ingenia Technology, in a product design team to implement a novel authentication technology called Laser Surface Authentication (LSA). After 2 years at Ingenia, I returned to work and pursue a PhD at the Institute of Biomedical Engineering, Imperial College London.

PUBLICATIONS AND KEY REFERENCES

K B Mirza, S Paraskevopoulou , A Eftekhar , C Toumazou, “Focussed Pulsed Ultrasonic Waves for Non-Invasive Neural Stimulation” in *3rd European Symposium on Focused Ultrasound Therapy, 2015, European Focused Ultrasound Society (EUFUS)* .

K B Mirza, S Luan, A Eftekhar, T G Constandinou , “Towards a fully-integrated solution for capacitor-based neural stimulation” in *Circuits and Systems (ISCAS), 2012 IEEE International Symposium on* (pp. 2243–2246). IEEE.

K Behrns, “Bariatric Surgery and Long-term Cardiovascular Events,” *Yearbook of Surgery*, vol. 2012, pp. 236{238, 2012}.

H R Berthoud, “The vagus nerve, food intake and obesity,” *Regulatory Peptides*, vol. 149 pp. 15{25, 2008}.

Figure 1. Pressure distribution plot generated using FOCUS for FUS at a depth of 10 mm in a layered media for continuous (top), pulsed (middle) ultrasonic waves in a 64 element linear array.

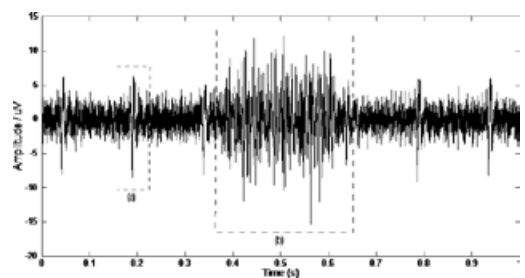
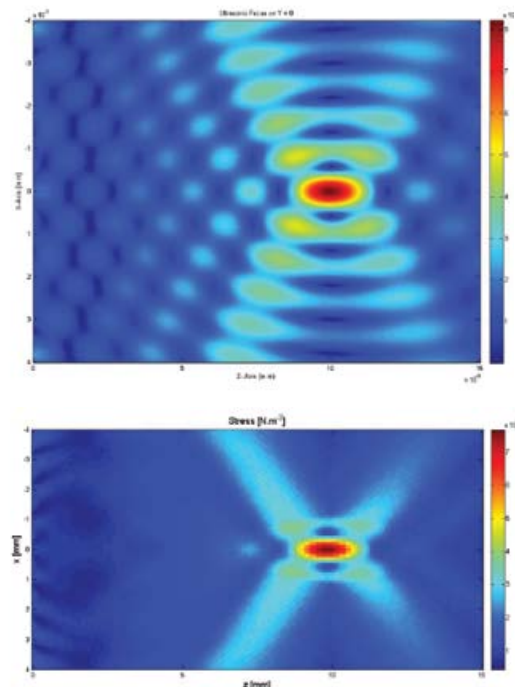

Figure 2. Neural mass activity recording on the vagus nerve coinciding with (a) heart rate and (b) breathing.



Nicolas Moser

Research focus

Distributed sensing platforms for ion-imaging and diagnostics

Supervisor

Dr Pantelis Georgiou

Funding

EPSRC HiPEDS CDT

MOTIVATION

ISFETs have been used extensively in the past as floating gate transistors exhibiting inherent sensitivity to pH and simple integration in CMOS technology. These sensors ultimately allow for efficient and low-cost DNA sequencing platforms, which serve for numerous applications, ranging from the diagnostics of genetic anomalies to the detection of genes which indicate microbial resistance inside the whole genome of bacteria.

Recently, the deposition of special membranes has also allowed such a platform to yield sensitivity to other ions such as potassium or sodium, which, if monitored, could help prevent collapse during exercise for athletes or soldiers.

OBJECTIVES

- Develop a working prototype of a universal ion detection platform using CMOS technology.
- Compensate for sensor nonidealities, such as trapped charge or drift, at device level.
- Investigate applications for such a device in the fields of early diagnostics and patient monitoring, including DNA sequencing for antimicrobial resistance and capillary blood detection.

RECENT ACHIEVEMENT

Nicolas has been part of the wafer run of May 2016, where he has designed an ISFET array with more than 4000 sensors, implementing in-pixel quantisation and compensation. Last September, he has sent for fabrication a novel array in TSMC 65nm, where each sensor behaves autonomously and performs averaging to improve the resolution of the measurement.

He has also presented his work on the multi-ion detection platform at ISCAS16 Montreal, as part of a

special session on Lab-on-CMOS. His work on both ISFET instrumentation and scaling to deeper nodes was also presented at the IEEE BioCAS 2016 conference in Shanghai.

BIOGRAPHY

Nicolas obtained his Bachelor's Degree in Electronics and Chemical Engineering at the Université Catholique de Louvain (UCL) in Belgium in 2013. He then graduated in 2014 with an MSc Degree at Imperial College London in Analogue & Digital Integrated Circuit Design, where he received the Award for the best MSc project with significant original contribution to the topic area and the MSc Outstanding Achievement Prize. He is now in the third year of a PhD programme part of the Centre for Doctoral Training in High Performance Embedded and Integrated Systems (HiPEDS).

PUBLICATIONS AND KEY REFERENCES

N Moser, T S Lande, C Toumazou, P Georgiou, "ISFETs in CMOS and Emergent Trends in Instrumentation: A Review," in *IEEE Sensors Journal*, vol. 16, no. 17, pp. 6496–6514, Sept.1, 2016.

N Moser, T S Lande, P Georgiou, "A Robust ISFET Array with In-Pixel Quantisation and Automatic Offset Calibration," *Biomedical Circuits and Systems Conference (BioCAS)*, 2015 IEEE, Shanghai, 2016.

N Moser, C L Leong, Y Hu, M Boutelle, P Georgiou, "An ion imaging ISFET array for Potassium and Sodium detection," 2016 IEEE International Symposium on Circuits and Systems (ISCAS), Montreal, QC, 2016, pp. 2847–2850.

N Moser, T S Lande, P Georgiou, "A novel pH-to-time ISFET pixel architecture with offset compensation," 2015 IEEE International Symposium on Circuits and Systems (ISCAS), Lisbon, 2015, pp. 481–484.

Left: TITANICKS – The array contains more than 4000 sensors able to encode the signal and compensate for nonidealities at device level

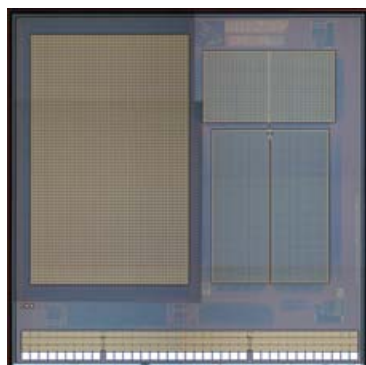

Right: Multi-Ion platform – The array exhibits sensitivity to both potassium and sodium where the membranes are deposited.

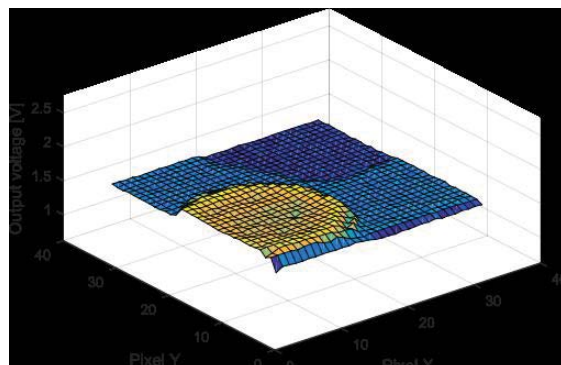

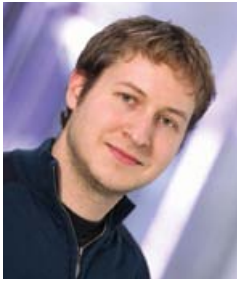

Peter Pesl

Research focus
Personalised Decision Support for Diabetes Management

Supervisor
Dr Pantelis Georgiou

Funding
Wellcome Trust

MOTIVATION

People with type 1 diabetes (T1D) find achieving healthy glucose levels after meals challenging due to sub-optimal insulin and carbohydrate matching. My research aims to overcome this challenge by developing a smartphone-based decision support tool for people with T1D (see Figure 1), which is able to suggest personalised insulin advice for meals, while automatically revising and adjusting recommendations for various daily life scenarios (e.g. exercise).

OBJECTIVES

- Development of a user-friendly, personalised and adaptive decision support tool to help people with T1D in the decision making of how much insulin is needed for a specific meal
- Clinical evaluation assessing safety and feasibility of the developed insulin dosing advisory system in clinical and real-life setting
- Optimisation of the system based on results of clinical trials (i.e. usability, safety, etc.)

RECENT ACHIEVEMENT

In early 2016, I have completed my PhD programme with the focus on a novel and adaptive insulin dosing decision support system called the 'Advanced Bolus Calculator for Diabetes' (ABC₄D). During the following summer, I have completed a work sabbatical at Dexcom, Inc., CA, USA, a continuous glucose sensor manufacturer, collaboratively working on improvements for insulin dosing decision support. Currently, the ABC₄D system, which has been developed during the time of my PhD, and improved during the work sabbatical, is currently being evaluated in a large-scale clinical trial on people with T1D.



Smartphone-based insulin decision support app, suggesting a personalised insulin dose for a specific meal

BIOGRAPHY

I received the engineering degree in Electronics and Technical Computer Science at HTL Leonding in 2005 and the Dipl-Ing (FH) degree at the University of Applied Sciences Linz in Medical Engineering in 2010. In 2011, I joined the Institute of Biomedical Engineering at Imperial College, working on the development of novel diabetes technologies such as the Bio-Inspired Artificial Pancreas. At the same time, I was working towards the PhD degree focusing on intelligent decision support systems for diabetes management, which I completed in 2016. I am currently working as a research associate within the Centre for Bio-inspired Technologies and the Department of Electrical and Electronic Engineering.

PUBLICATIONS AND KEY REFERENCES

- P Pesl, P Herrero, M Reddy, *et al.*, "An Advanced Bolus Calculator for Type 1 Diabetes: System Architecture and Usability Results", *IEEE Journal of Biomedical and Health Informatics*, vol.20, pp.11–17, 2016
- P Pesl, P Herrero P, M Reddy, *et al.*, "Case-Based Reasoning for Insulin Bolus Advice: Evaluation of Case Parameters in a Six-Week Pilot Study", *Journal of Diabetes Science and Technologies* (Epub ahead of print), vol.99, 2016
- M Reddy, P Pesl, M Xenou, *et al.*, 2016, "Clinical Safety and Feasibility of the Advanced Bolus Calculator for Type 1 diabetes based on Case-Based Reasoning: A 6-Week Non-randomised Single-arm Pilot Study", *Diabetes Technology & Therapeutics* (Epub ahead of print), vol.99, 2016



Adrien Rapeaux

Research focus

Algorithms and Systems for Highly Selective Neural Interfacing

Supervisor

Dr Timothy Constandinou

Funding EPSRC Centre for Doctoral Training (CDT) in High Performance Embedded & Distributed Systems (HiPEDS) and EPSRC SenseBack (EP/Mo25977/1)

MOTIVATION

Today's implantable neural electrodes feature a characteristic tradeoff between selectivity and invasiveness, with low-invasiveness electrodes being more reliable yet less precise and more invasive electrodes yielding better quality interfaces at the cost of implant lifetime (and often regulatory approval for use in humans).

My research looks at making less invasive electrodes for the peripheral nervous system (PNS) more powerful tools by leveraging specialized algorithms and systems for stimulation and recording, for maximum impact with existing, FDA-approved technologies.

OBJECTIVES

- Design an experimental platform to test algorithms acutely *in-vivo*
- Develop a numerical modelling framework for testing new stimulation and recording methodologies *in-silico* and reduce animal experimentation
- Implement successful methodologies into chronically implantable stimulation and recording control systems

RECENT ACHIEVEMENT

Have begun *in-vivo* experiments using high-frequency nerve block to selectively stimulate nerve fiber populations by size.

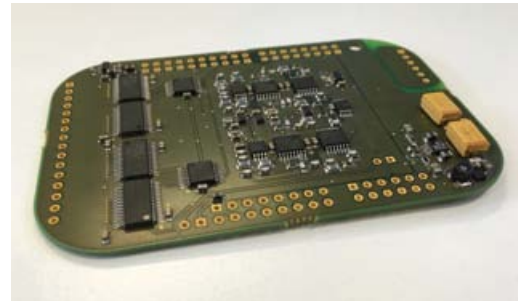

PCB-based neural interface for acute *in-vivo* experiments

BIOGRAPHY

Adrien Rapeaux is a graduate engineer from Phelma school of Engineering in Grenoble, France. He developed a nerve fiber size-selective stimulation algorithm during his final Engineering degree year as an exchange at Imperial College London, during which he was supervised by Dr. Constandinou. From there he joined the Next Generation Neural Interfaces (NGNI) Group within the Centre for Bio-Inspired Technology as a PhD student in the HiPEDS (High Performance Embedded and Distributed Systems) programme.

He is now in the second year of his PhD and has designed the stimulator in a bidirectional neural interface as part of the multi-university project SenseBack.

PUBLICATIONS AND KEY REFERENCES

A Rapeaux, K Nikolic, I Williams, A Eftekhar, TG Constandinou, "Fiber size-selective stimulation using action potential filtering for a peripheral nerve interface: a simulation study", *Proc. IEEE Engineering in Medicine & Biology Society (EMBS) Conference*, pp. 3411–3414, 2015.

I Williams, A Rapeaux, Y Liu, S Luan, TG Constandinou, "A 32-Channel Bidirectional Neural/EMG Interface with on-Chip Spike Detection for Sensorimotor Feedback" *Proc. IEEE Biomedical Circuits and Systems (BioCAS) Conference*, pp. 528–531, 2016.

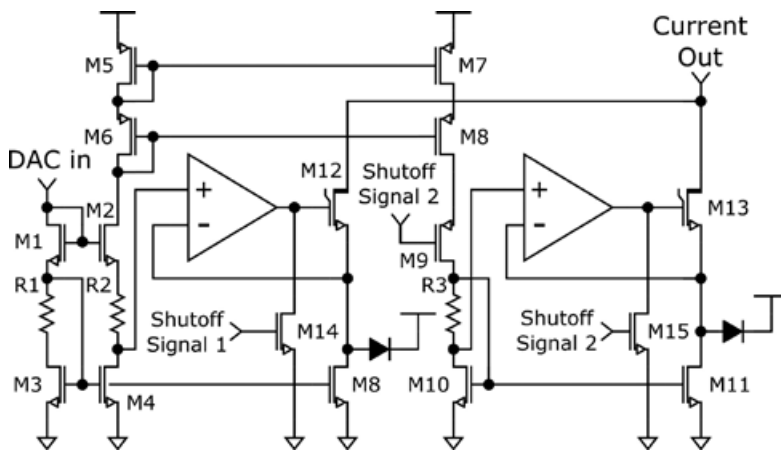

Schematic for the output buffer of the stimulator used in project SenseBack



Francesca Troiani

Research focus

Optical Coherence Tomography for detection of compound action potential

Supervisors

Dr Timothy Constandinou and Dr Konstantin Nikolic

Funding

EPSRC DTA and EEE Departmental Scholarship

MOTIVATION

Currently it is not possible to record neural activity without having to choose between a non-invasive setup and a good resolution. This creates the need for a new methodology that would act like a bridge between non-invasive (and low resolution) and invasive (and high resolution) techniques.

In the 1960s neuroscientists have discovered changes in light scattered from a neuron during action potential and, since then, optical properties of neurons have been extensively studied. Thus the use of light, with its characteristic to travel through matter, seems to be the best chance to detect neural activity non-invasively.

OBJECTIVES

- Measuring nerve activity non-invasively using optical techniques
- Creating an artificial model for the optical properties of the nerve
- Creating a theoretical model for the nerve and simulating optical detection of action potential

RECENT ACHIEVEMENT

I have spent the last 12 months, in part, investigating an analytical model for the optical coherence tomography setup, and secondly, developing a simulation method for establishing the expected 2D response. In February 2016, I attended SPIE BiOS Photonics West where I presented my work on “Optical coherence tomography for detection of compound action potential in *Xenopus Laevis* sciatic nerve”. At the same conference I was awarded the Newport Research Excellence Award.

BIOGRAPHY

I received my BSc in Physics in 2011 and my MSc in nuclear and subnuclear physics (*cum laude*) in 2013 from University of Trieste, Italy. My MSc project was done in collaboration with a group of physicists at SISSA (International School for Advanced Studies) on a computational model for grid cells. After graduation I was awarded a 6-month postgraduate fellowship from SISSA to continue my work on the formation of spatial representations on hyperbolic surfaces. I have joined the Next Generation Neural Interfaces (NGNI) group within the Centre for Bio-inspired Technology as a PhD candidate in August 2014.

PUBLICATIONS AND KEY REFERENCES

F Troiani, K Nikolic, TG Constandinou, “Optical coherence tomography for detection of compound action potential in *Xenopus Laevis* sciatic nerve”, *Proc. SPIE BiOS*, vol. 96901, pp. F1–F7, 2016.

D Huang, *et al.*, “Optical coherence tomography”, *Science*, vol. 254, no. 5035, pp. 1178–1181, 1991.

LB Cohen, RD Keynes, B Hille, “Light scattering and birefringence changes during nerve activity”, *Nature*, vol. 218, pp. 438–441, 1968.

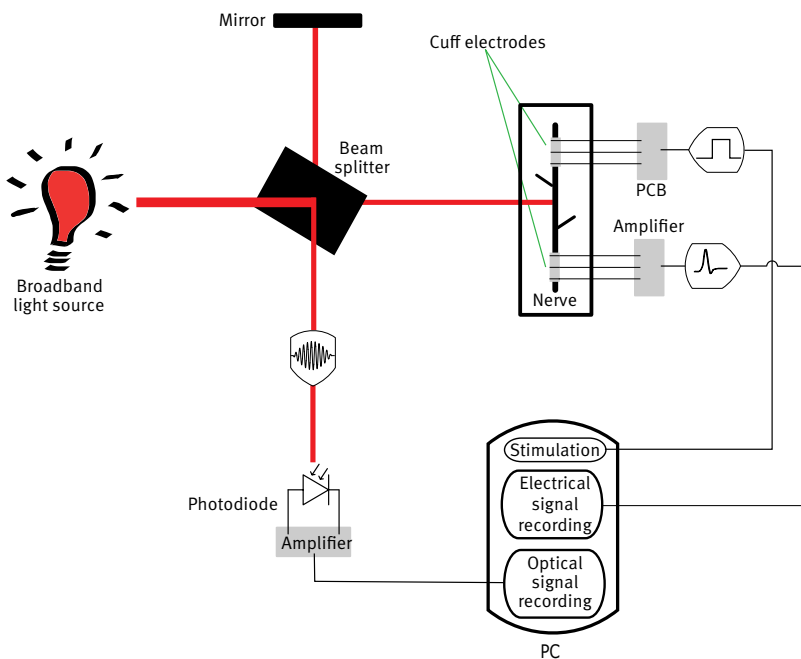

Concept experimental setup for utilising OCT for neural activity detection

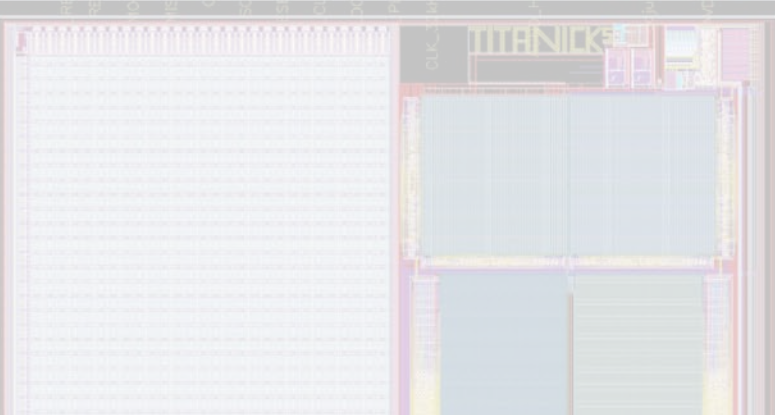
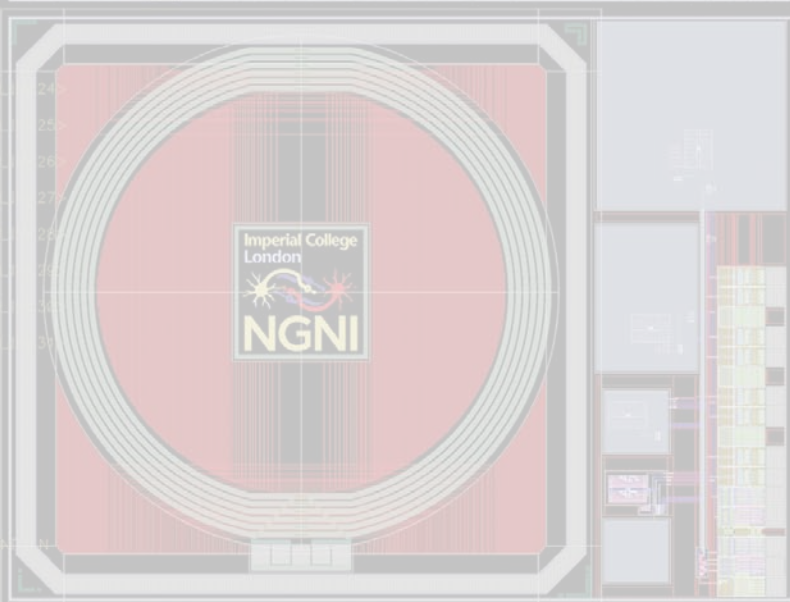
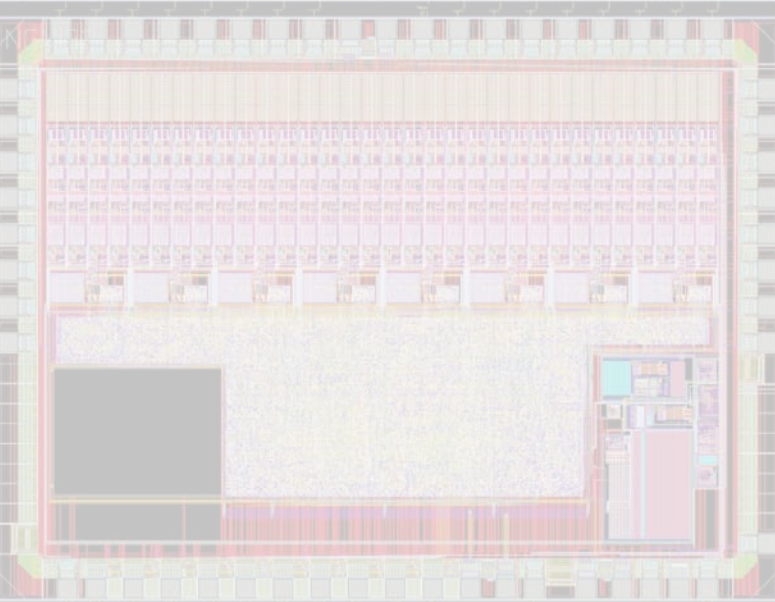
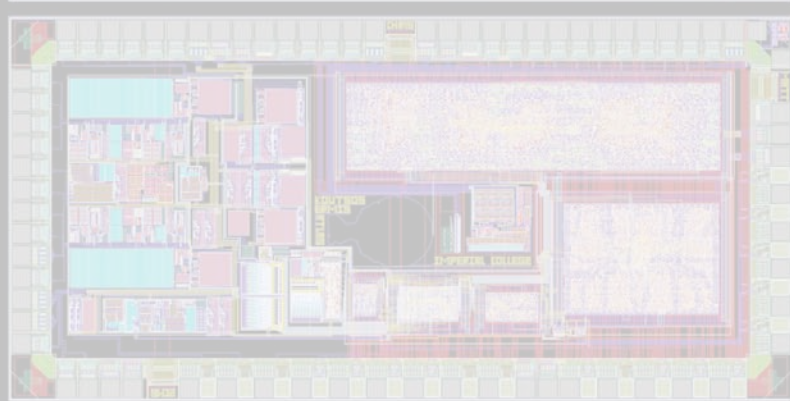
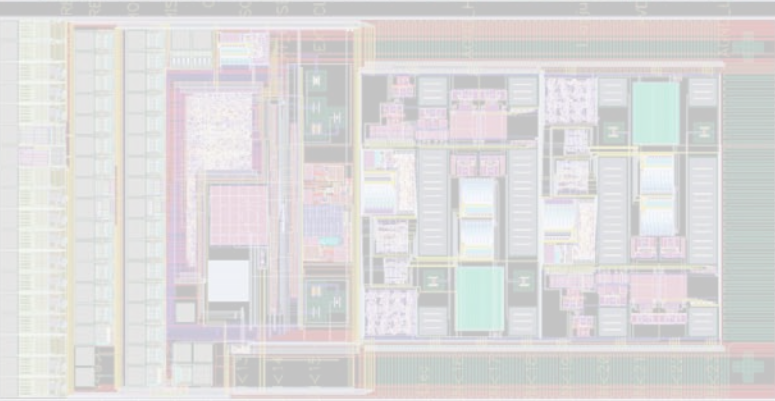
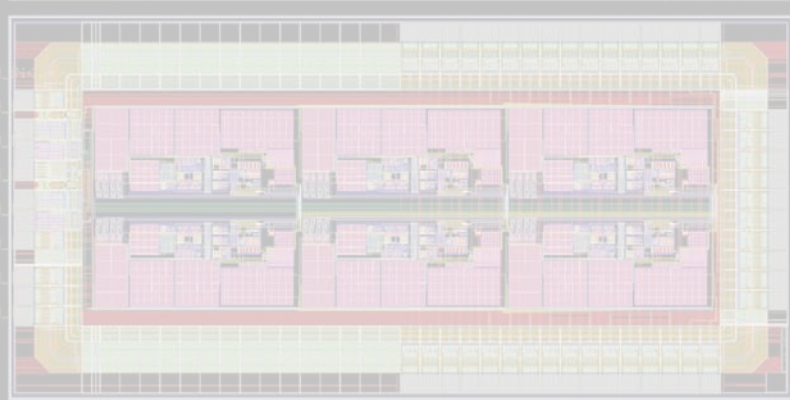
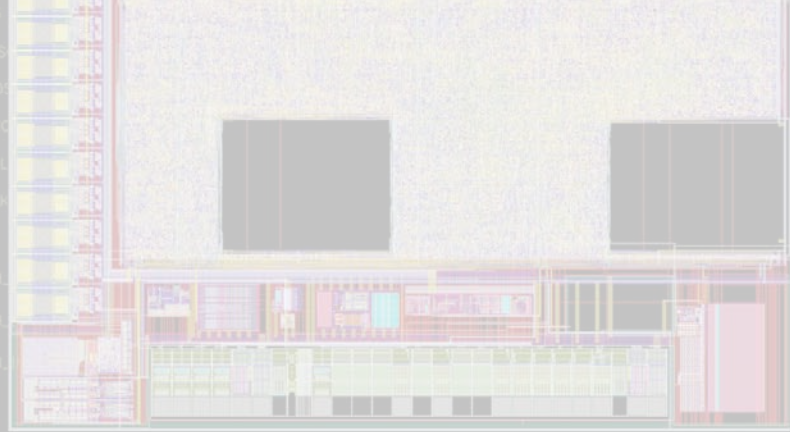

Imperial College London

Centre for Bio-Inspired Technology
Institute of Biomedical Engineering
Imperial College London
South Kensington
London SW7 2AZ

T +44 (0)20 7594 0701

F +44 (0)20 7594 0704

bioinspired@imperial.ac.uk

www.imperial.ac.uk/bioinspiredtechnology

